

NCHRP

Web-Only Document 108:

Guide for Pavement Friction

J.W. Hall
K.L. Smith
L. Titus-Glover
Applied Research Associates, Inc.
Champaign, IL

J.C. Wambold
CDRM, Inc.
State College, PA

T.J. Yager
NASA Langley Research Center
Hampton, VA

Z. Rado
Pennsylvania Transportation Institute
University Park, PA

Contractor's Final Report for NCHRP Project 01-43
Submitted February 2009

National Cooperative Highway Research Program

TRANSPORTATION RESEARCH BOARD
OF THE NATIONAL ACADEMIES

ACKNOWLEDGMENT

This work was sponsored by the American Association of State Highway and Transportation Officials (AASHTO), in cooperation with the Federal Highway Administration, and was conducted in the National Cooperative Highway Research Program (NCHRP), which is administered by the Transportation Research Board (TRB) of the National Academies.

COPYRIGHT PERMISSION

Authors herein are responsible for the authenticity of their materials and for obtaining written permissions from publishers or persons who own the copyright to any previously published or copyrighted material used herein.

Cooperative Research Programs (CRP) grants permission to reproduce material in this publication for classroom and not-for-profit purposes. Permission is given with the understanding that none of the material will be used to imply TRB, AASHTO, FAA, FHWA, FMCSA, FTA, Transit Development Corporation, or AOC endorsement of a particular product, method, or practice. It is expected that those reproducing the material in this document for educational and not-for-profit uses will give appropriate acknowledgment of the source of any reprinted or reproduced material. For other uses of the material, request permission from CRP.

DISCLAIMER

The opinion and conclusions expressed or implied in the report are those of the research agency. They are not necessarily those of the TRB, the National Research Council, AASHTO, or the U.S. Government.

This report has not been edited by TRB.

THE NATIONAL ACADEMIES

Advisers to the Nation on Science, Engineering, and Medicine

The **National Academy of Sciences** is a private, nonprofit, self-perpetuating society of distinguished scholars engaged in scientific and engineering research, dedicated to the furtherance of science and technology and to their use for the general welfare. On the authority of the charter granted to it by the Congress in 1863, the Academy has a mandate that requires it to advise the federal government on scientific and technical matters. Dr. Ralph J. Cicerone is president of the National Academy of Sciences.

The **National Academy of Engineering** was established in 1964, under the charter of the National Academy of Sciences, as a parallel organization of outstanding engineers. It is autonomous in its administration and in the selection of its members, sharing with the National Academy of Sciences the responsibility for advising the federal government. The National Academy of Engineering also sponsors engineering programs aimed at meeting national needs, encourages education and research, and recognizes the superior achievements of engineers. Dr. Charles M. Vest is president of the National Academy of Engineering.

The **Institute of Medicine** was established in 1970 by the National Academy of Sciences to secure the services of eminent members of appropriate professions in the examination of policy matters pertaining to the health of the public. The Institute acts under the responsibility given to the National Academy of Sciences by its congressional charter to be an adviser to the federal government and, on its own initiative, to identify issues of medical care, research, and education. Dr. Harvey V. Fineberg is president of the Institute of Medicine.

The **National Research Council** was organized by the National Academy of Sciences in 1916 to associate the broad community of science and technology with the Academy's purposes of furthering knowledge and advising the federal government. Functioning in accordance with general policies determined by the Academy, the Council has become the principal operating agency of both the National Academy of Sciences and the National Academy of Engineering in providing services to the government, the public, and the scientific and engineering communities. The Council is administered jointly by both the Academies and the Institute of Medicine. Dr. Ralph J. Cicerone and Dr. Charles M. Vest are chair and vice chair, respectively, of the National Research Council.

The **Transportation Research Board** is one of six major divisions of the National Research Council. The mission of the Transportation Research Board is to provide leadership in transportation innovation and progress through research and information exchange, conducted within a setting that is objective, interdisciplinary, and multimodal. The Board's varied activities annually engage about 7,000 engineers, scientists, and other transportation researchers and practitioners from the public and private sectors and academia, all of whom contribute their expertise in the public interest. The program is supported by state transportation departments, federal agencies including the component administrations of the U.S. Department of Transportation, and other organizations and individuals interested in the development of transportation. www.TRB.org

www.national-academies.org

TABLE OF CONTENTS

LIST OF FIGURES.....	v
LIST OF TABLES	vii
ACKNOWLEDGMENTS	viii
ABSTRACT	ix
SUMMARY	x
1. INTRODUCTION.....	1
BACKGROUND.....	1
DESCRIPTION OF THE PROBLEM	1
PROJECT OBJECTIVES AND SCOPE.....	2
OVERVIEW OF REPORT	3
2. INFORMATION GATHERING	5
INTRODUCTION.....	5
LITERATURE SEARCH.....	5
STATE FRICTION SURVEY	6
STATE AND INDUSTRY INTERVIEWS	7
3. PAVEMENT FRICTION AND HIGHWAY SAFETY	9
HIGHWAY SAFETY.....	9
RELATIONSHIP BETWEEN WET-WEATHER CRASHES AND HIGHWAY PAVEMENT SURFACE CONDITION	11
Wet-Weather Crashes and Pavement Friction.....	11
Wet-Weather Crashes and Splash/Spray	16
4. PAVEMENT FRICTION AND SURFACE TEXTURE	19
PAVEMENT FRICTION	19
Definition.....	19
Friction Mechanisms	24
Factors Affecting Available Pavement Friction.....	26
PAVEMENT SURFACE TEXTURE.....	30
Definition.....	30
Factors Affecting Texture.....	32
FRICTION AND TEXTURE MEASUREMENT METHODS.....	33
Overview	33
Friction.....	34
Texture	36
Summary of Test Methods and Equipment	37

TABLE OF CONTENTS (CONTINUED)

FRICION INDICES.....	45
Friction Number	45
International Friction Index.....	45
Rado IFI Model.....	47
Index Relationships	49
5. PAVEMENT FRICTION MANAGEMENT	53
INTRODUCTION.....	53
FEDERAL MANDATES.....	53
Highway Safety Act of 1966 (23 USC Chapter 4).....	53
Highway Safety Program Standard 12 (HSPS No. 12) of 1967	54
FHWA Instructional Memorandum 21-2-73	54
1975 Federal-Aid Highway Program Manual	54
1980 FHWA <i>Technical Advisory T 5040.17</i>	54
Intermodal Surface Transportation Efficiency Act (ISTEA) of 1991.....	55
National Highway System (NHS) Designation Act of 1995	55
Transportation Equity Act for the 21st Century of 1998 (TEA-21).....	55
2005 FHWA <i>Technical Advisory T 5040.36</i>	57
PAVEMENT FRICTION MANAGEMENT FRAMEWORK.....	57
ESTABLISHING THE PAVEMENT FRICTION MANAGEMENT PROGRAM... 60	
Defining Network Pavement Sections.....	60
Establishing Friction Demand Categories	66
Data Collection.....	69
Data Analysis	73
Detailed Site Investigation.....	80
Selection and Prioritization of Restoration Treatments	84
Pavement Friction Management Approach and Framework	84
6. PAVEMENT FRICTION DESIGN.....	87
INTRODUCTION.....	87
FRICTION DESIGN POLICIES.....	87
Consideration of Aggregate in Friction Design.....	87
Surface Mix Types and Texturing Techniques.....	99
Design Policy for Friction and Texture.....	99
PROJECT-LEVEL FRICTION DESIGN	108
Step 1—Determining Design Friction Level.....	108
Step 2—Selecting Aggregates.....	109
Step 3—Establishing Surface Mix Types and/or Texturing Techniques ..	110
Step 4—Development of Construction Specifications	119
Step 5—Formulation of Design Strategies.....	120
7. CONCLUSIONS AND RECOMMENDATIONS	123
CONCLUSIONS	123
RECOMMENDATIONS	125

TABLE OF CONTENTS (CONTINUED)

REFERENCES	127
APPENDIX A. BIBLIOGRAPHY.....	A-1
APPENDIX B. STATE FRICTION SURVEY FORM.....	B-1
APPENDIX C. SUMMARY OF STATE FRICTION SURVEY RESPONSES.....	C-1
APPENDIX D. SUMMARY OF STATE AND INDUSTRY INTERVIEWS	D-1
APPENDIX E. PRIMER ON FRICTION	E-1

LIST OF FIGURES

	<u>Page</u>
Figure 1. Agencies participating in the project survey.....	7
Figure 2. Total crashes (from all vehicle types) on U.S. highways from 1990 to 2003 (NHTSA, 2004)	10
Figure 3. Total fatalities (from all vehicles types) on U.S. highways from 1990 to 2003 (NHTSA, 2004)	10
Figure 4. Relationship between wet-weather crash rates and pavement friction for Kentucky highways (Rizenbergs et al., 1973)	12
Figure 5. Ratio of wet-to-dry pavement crashes versus pavement friction for Kentucky highways (Rizenbergs et al., 1973)	12
Figure 6. Relationship between wet crashes as compared to pavement surface friction (Schulze et al., 1976).....	15
Figure 7. Relationship between pavement friction and crash risk (Viner et al., 2004)	16
Figure 8. Simplified diagram of forces acting on a rotating wheel	19
Figure 9. Rolling resistance force with a free-rolling tire at a constant speed on a bare, dry paved surface (Andresen and Wambold, 1999)	21
Figure 10. Forces and moments of a constant-braked wheel on a bare, dry paved surface (Andresen and Wambold, 1999).....	21
Figure 11. Pavement friction versus tire slip.....	22
Figure 12. Dynamics of a vehicle traveling around a constant radius curve at a constant speed, and the forces acting on the rotating wheel.....	23
Figure 13. Brake (F_x) and lateral (F_y) forces as a function of longitudinal slip (Gillespie, 1992)	24
Figure 14. Lateral forces versus longitudinal force at constant slip angles (Gillespie, 1992)	24
Figure 15. Key mechanisms of pavement–tire friction.....	25
Figure 16. Micro-texture versus macro-texture (Flintsch et al., 2003).....	27
Figure 17. Effect of water film thickness on pavement friction (Henry, 2000)	28
Figure 18. Simplified illustration of the various texture ranges that exist for a given pavement surface (Sandburg, 1998)	31
Figure 19. Texture wavelength influence on pavement–tire interactions (adapted from Henry, 2000 and Sandburg and Ejsmont, 2002).....	31
Figure 20. Effect of micro-texture and macro-texture on pavement–tire wet friction at different sliding speeds (Flintsch et al., 2002)	32
Figure 21. The IFI friction model	47
Figure 22. The IFI and Rado IFI friction models (Rado, 1994).....	48
Figure 23. Model skid crash reduction program (FHWA, 1980)	56
Figure 24. Procedure for identification and prioritization of sites (Highways Agency, 2004)	58
Figure 25. Overview of a proactive strategy to manage friction on road networks (Austroads, 2005).....	59
Figure 26. Simplified example of a friction strategy currently operated by a state road authority in Australia utilizing SCRIM (Austroads, 2005)	59

LIST OF FIGURES (CONTINUED)

	<u>Page</u>
Figure 27. Change in highway cross-section as the horizontal alignment transitions from a tangent to a curve	62
Figure 28. Lateral forces that act on a vehicle as it travels along a curve.....	62
Figure 29. Lateral sliding.....	62
Figure 30. Relationship between friction demand, speed, and friction availability	66
Figure 31. Illustration of Iowa’s highway safety data integration and analysis system (Iowa DOT, 2005).....	72
Figure 32. Setting of investigatory and intervention levels for a specific friction demand category using time history of pavement friction	74
Figure 33. Setting of investigatory and intervention levels for a specific friction demand category using time history of friction and crash rate history	75
Figure 34. Setting of investigatory and intervention levels for a specific friction demand category using pavement friction distribution and crash rate–friction trend.....	76
Figure 35. Determination of friction and/or texture deficiencies using the IFI	80
Figure 36. Example PFM program	85
Figure 37. Example illustration of matching aggregate sources and mix types/ texturing techniques to meet friction demand.....	107
Figure 38. Example of determining <i>DFT(20)</i> and <i>MPD</i> needed to achieve design friction level	111
Figure 39. Asphalt pavement friction design methodology (Sullivan, 2005).....	112
Figure 40. Vehicle response as function of <i>PSV</i> and <i>MTD</i> (Sullivan, 2005)	112
Figure 41. Typical asphalt mix aggregate gradations (WAPA, 2004).....	114

LIST OF TABLES

		<u>Page</u>
Table 1.	List of hazards that can potentially be caused by splash and spray (NHTSA, 1998).....	17
Table 2.	Factors affecting available pavement friction (modified from Wallman and Astrom, 2001)	26
Table 3.	Factors affecting pavement micro-texture and macro-texture (Sandburg, 2002; Henry, 2000; Rado, 1994; PIARC, 1995, AASHTO, 1976)	33
Table 4.	Overview of highway-speed pavement friction test methods.....	38
Table 5.	Additional information on highway-speed pavement friction test methods	39
Table 6.	Overview of pavement friction test methods requiring traffic control	40
Table 7.	Additional information on pavement friction test methods requiring traffic control.....	41
Table 8.	Overview of highway-speed pavement surface texture test methods.....	42
Table 9.	Additional information on highway-speed pavement surface texture test methods.....	42
Table 10.	Overview of pavement surface texture test methods requiring traffic control.....	43
Table 11.	Additional information on pavement surface texture test methods requiring traffic control.....	44
Table 12.	Example criteria for highway features/environment factors corresponding to different friction demand levels (modified from TXDOT, 2004)	64
Table 13.	Typical friction demand categories.....	67
Table 14.	Summary of key issues to be considered in standardizing test conditions	70
Table 15.	Examples of useable crash statistics	71
Table 16.	Levels of pavement friction required for various friction demand categories (VicRoads/RTA, 1996).....	77
Table 17.	Levels of pavement friction required for various friction demand categories (Transit New Zealand, 2002)	77
Table 18.	Friction demand categories used by Maryland SHA (Chelliah et al., 2003)	78
Table 19.	U.K. site categories and investigatory levels (Viner et al., 2004)	79
Table 20.	Assessment of hydroplaning potential based on vehicle speed and water Film thickness.....	82
Table 21.	Recommended actions for detailed site investigations (Chelliah et al., 2003; TXDOT, 2004; Austroads, 2005; Viner et al., 2004)	83
Table 22.	Effect of aggregate angularity, shape, and texture properties on pavement friction	89
Table 23.	Test methods for characterizing aggregate frictional properties.....	91
Table 24.	Typical range of test values for aggregate properties.....	96
Table 25.	Asphalt pavement surface mix types and texturing techniques.....	100
Table 26.	Concrete pavement surface mix types and texturing techniques	102
Table 27.	Recommended levels of aggregate PSV for various site and friction requirement categories (Flintsch et al., 2002)	105
Table 28.	Pairs of <i>MPD</i> and <i>DFT(20)</i> needed to achieve design friction level of 40.....	111

ACKNOWLEDGMENTS

The research described herein was performed under NCHRP Project 1-43 by the Transportation Sector of Applied Research Associates (ARA), Inc. Dr. Jim W. Hall, Jr., was the Principal Investigator for the study.

Dr. Hall was supported in the research by ARA Research Engineers Mr. Kelly Smith, Mr. Leslie Titus-Glover, and Mr. Lynn Evans, and by three project consultants—Dr. James Wambold (President of CDRM, Inc. and Professor Emeritus of Mechanical Engineering at Penn State University), Mr. Thomas Yager (Senior Research Engineer at the NASA Langley Research Center), and Mr. Zoltan Rado (Senior Research Associate at the Pennsylvania Transportation Institute).

The authors gratefully acknowledge all of the individuals with state departments of transportation (DOTs) who responded to the pavement friction survey conducted for this project. The authors also express their gratitude for the valuable input provided by knowledgeable representatives of DOTs, paving associations, academia, and manufacturers of friction measuring equipment, vehicle tires, and trucks.

ABSTRACT

This report documents the research performed under NCHRP Project 1-43. It describes the work activities undertaken in the study and presents the results of those activities toward the development of the Guide for Pavement Friction. The information provided in this report serves as the basis for many of the guidelines and recommendations contained in the Guide. The information will be of interest to highway materials, construction, pavement management, safety, design, and research engineers, as well as others concerned with the friction and related surface characteristics of highway pavements.

Using information collected through detailed literature reviews and surveys/interviews with state highway agencies, this report discusses a variety of aspects regarding pavement friction. It describes and illustrates the importance of friction in highway safety, as well as the principles of friction, as defined by micro-texture and macro-texture. It identifies the factors affecting friction and examines the ways that friction can be measured (equipment and procedures) and expressed (reporting indices). Most importantly, it presents valuable information on (a) the management of friction on existing highway pavements and (b) the design of new highway surfaces with adequate friction. This information focuses on techniques for monitoring friction and crashes and determining the need for remedial action, as well as identifying combinations of aggregate (micro-texture) and mix types/surface texturing methods (macro-texture) that satisfy friction design requirements.

The report includes various conclusions and recommendations based on the results of the study, and it features five appendixes containing supplemental information on friction.

SUMMARY

This report describes and illustrates pavement friction (as defined by micro-texture and macro-texture) and discusses the importance of pavement friction in highway safety. It identifies the factors affecting pavement friction and examines the equipment, procedures, and indices used to quantify and report available friction. Most importantly, the report presents valuable information on (a) the management of pavement friction on existing highways and (b) the design of new highway surfaces with adequate pavement friction. The report is a useful resource for state personnel and others involved in managing, planning, and designing highway pavements.

Pavement friction design is one of the key elements required for ensuring highway safety, as empirical evidence suggests that vehicle crashes are highly correlated to the amount of pavement friction available at the pavement–tire interface. Although comprehensive guidance covering both the policy and technical aspects of designing for and managing pavement friction was provided in *Guidelines for Skid-Resistant Pavement Design*, published by AASHTO in 1976, many significant improvements in design and material characterization have taken place since this time. Moreover, although more current information and guidance related to pavement friction is available, it is quite fragmented and has not been integrated into a comprehensive administrative policy and design tool for addressing friction issues. Thus, a new Guide for Pavement Friction is needed to assist highway engineers in (a) understanding the complex subject of pavement friction and its importance to highway safety and (b) instituting pavement management and design practices and processes that optimize friction safety, while recognizing and considering the effects on economics and other pavement–tire interaction issues (e.g., noise, splash/spray, visibility/glare).

NCHRP Project 1-43, titled “Guide for Pavement Friction,” was conducted to address this need. Under this project, Applied Research Associates (ARA), Inc., was assigned the task of developing a new Guide—for consideration and adoption by AASHTO—that addresses the frictional characteristics and performance of pavement surfaces constructed with asphalt and concrete and considers pavement–tire noise and other relevant issues.

This report describes and documents the work done to achieve the Project 1-43 objectives. Such work consisted of (a) information gathering through an immense literature search, state surveys, and state and industry interviews, (b) development of pavement friction management principles, and (c) development of pavement friction design procedures.

Information gathering focused primarily on collecting national and international literature pertaining to pavement friction, texture, and other related surface characteristics. Also targeted in the search was information on user safety, as impacted by deficiencies in pavement friction, and economic considerations in the design of pavements with adequate friction. To determine the state-of-the-practice regarding the evaluation and design of pavement friction, texture, and noise, a six-page questionnaire survey was developed and distributed to all State Highway Agencies (SHAs) in the U.S., as well as Puerto Rico and Washington D.C. A substantial amount of information was obtained from these questionnaires and follow-up interviews, and the details of each discussion were fully

documented in interview memoranda. The information gathered was used to develop pavement friction management and design procedures.

In establishing a pavement friction management (PFM) program, a full understanding of federal and state legislative mandates regarding highway safety is needed, along with an understanding of the agency's management/operational practices and resources (people, equipment, materials) available. Also of importance is an understanding of the following:

1. Factors that affect friction demand, categorized by highway alignment, highway features/environment, highway traffic characteristics, and driver/vehicle characteristics.
2. Strategies for establishing pavement friction demand categories.
3. Friction testing protocols (including equipment).
4. Crash data collection methodology and analysis.

A practical approach to friction management and design developed and presented in this report is based on the principle that an appropriate level of pavement friction must be maintained across all pavement sections within a given highway network. The level of friction considered appropriate must be determined based on each section's friction demand and it is imperative that friction supply meet or exceed friction demand at all times. This design approach ensures the provision of adequate friction levels economically for a variety of roadway (intersections, approaches to traffic signals, tight curves) and traffic conditions across a given network.

The adequacy of friction (for both management and design) is assessed using two distinct threshold levels defined by the agency—investigatory and intervention. The establishment of investigatory and intervention friction levels requires detailed analyses of pavement surface micro-texture and macro-texture data, and crash data, if available. Presented in this report are three feasible methods for setting investigatory and intervention friction levels. It is recommended that one of the three methods be used.

Pavement sections with measured friction values at or below an assigned investigatory level are subject to a detailed site investigation to determine the need for remedial action, such as erecting warning signs, performing more frequent testing and analysis of friction data and crash data, or applying a short-term restoration treatment. For pavement sections with friction values at or below the intervention level, remedial action may consist of immediately applying a restoration treatment or programming a treatment into the maintenance or construction work plan and/or erecting temporary warning signs at the site of interest.

Pavement friction design is basically a process of selecting the right combination of pavement surface micro-texture and macro-texture to optimize available pavement friction for a given design situation. For both asphalt and concrete surfaces, micro-texture is defined by the surface aggregate material properties. The important aggregate properties that influence short- and long-term micro-texture are:

- Mineralogical and petrographic properties.
 - Aggregate composition/structure and mineral hardness.
- Physical and geometrical properties.
 - Angularity, shape, and texture.
- Mechanical properties.
 - Abrasion/wear resistance.
 - Polish characteristics.
- Durability properties.
 - Soundness.

Several test methods are available for characterizing aggregate frictional properties. The extent of aggregate testing and characterization required as part of the friction design process will vary from agency to agency, based on the types of aggregates available, the variability of aggregate properties, the quality and historical performance of available aggregates, and the anticipated applications (e.g., mix types, roadway functional class). Since laboratory material testing does not guarantee friction performance in the field, it is essential that testing be used in conjunction with field performance history to identify acceptable aggregate types.

Macro-texture is defined by the type of surface paving mixtures and/or surface texturing techniques applied. Several different surface mix types and finishing/texturing techniques are available for use in constructing new pavements and overlays, or for restoring friction on existing pavements. The more commonly used mix types and texturing techniques are presented in this report along with the typical macro-texture levels achieved. Pavement–tire considerations, such as noise, splash/spray, and hydroplaning, and general considerations, such as constructability, cost, and structural performance, are not directly discussed in this report, however, they must be an integral part of any policies developed for the application of these mixes and texturing techniques.

This page intentionally left blank.

CHAPTER 1. INTRODUCTION

BACKGROUND

Although the mission statements and goals of state departments of transportation (DOTs) vary from agency to agency, the terms “safe” and “safety” are prominently included in most pronouncements about highways. While the provision of highway facilities for mobility and economic purposes is usually the main priority of a highway agency, the safe operation of all vehicles using those facilities is often an equal or complementary priority.

As there are many facets and features in a highway system, there are many areas in which improvements to highway safety can take place. In one such area—pavement–tire friction (or, simply, pavement friction)—the campaign for improvements has been waged for decades, with many studies taking place at the state, national, and international levels. The results of these studies have been used to develop new or updated policies and standards for measuring and controlling friction.

Various forms of friction guidance have also been developed and made available over the years by transportation agencies and organizations. Most notable among these are:

- Federal Highway Administration (FHWA)—*Technical Advisories* on skid crash reduction, pavement friction courses, and pavement texturing.
- National Cooperative Highway Research Program (NCHRP)—*Syntheses* and *Reports* covering, among other things, safety, friction testing, and surface drainage.
- American Association of State Highway and Transportation Officials (AASHTO)—*Guides, Manuals, and Guide Specifications* for highway geometric design, construction, maintenance, and pavement management.
- Pavement industry groups—*Bulletins* and *Manuals* on surface mixture selection and texturing.
- International Agencies (e.g., United Kingdom, Australia, Japan)—Various guides, manuals, and reports on friction testing, design, and safety management.

Comprehensive guidance covering both the policy and technical aspects of designing for and managing pavement friction has been limited to *Guidelines for Skid-Resistant Pavement Design*, published by AASHTO in 1976. This document recommended pavement specifications that would yield the desired frictional properties upon completion of construction and that would maintain adequate long-term friction. It also discussed the importance of aggregate selection and mixture design for both asphalt- and concrete-surfaced pavements, and the role of micro-texture and macro-texture in pavement surface friction.

DESCRIPTION OF THE PROBLEM

Many changes have taken place since the development the 1976 AASHTO Guide. In addition to the continuous growth in the amount and type of highway traffic and the

increased focus on the needs of the highway user (i.e., safer and more comfortable roads), substantial technological changes have occurred in the following areas:

- Pavement materials and mixture design properties.
- Friction-testing methods and equipment.
- Construction procedures and standards.
- Vehicle and tire characteristics.
- Highway geometric design practices and standards.

Although much information and guidance related to pavement friction is available, it is quite fragmented and has not been integrated into a comprehensive administrative policy and design tool for addressing friction issues. Therefore, a new Guide for Pavement Friction is needed to assist highway engineers in (a) understanding the complex subject of pavement friction and its importance to highway safety and (b) instituting pavement management and design practices and processes that optimize friction safety, while recognizing and considering the effects on economics and other pavement–tire interaction issues (e.g., noise, splash/spray, visibility/glare).

PROJECT OBJECTIVES AND SCOPE

The primary objective of this research project was to develop a new Guide for Pavement Friction, for consideration and adoption by AASHTO and for subsequent use by highway engineers involved in designing, constructing, and managing pavement surfaces. The new Guide would address both asphalt (i.e., flexible and semi-rigid) and concrete (i.e., rigid) pavements and would serve as a supplement to existing structural and/or mix design practices. The new Guide would not address winter maintenance issues (i.e., snow and ice removal/treatment).

The scope of this research project consisted of the following tasks and subtasks:

Phase I

- Task 1—Collect and Review Information Related to Pavement Friction.
 - Subtask 1a—Perform Literature Search and Review.
 - Subtask 1b—Conduct State and Industry Surveys and Interviews.
- Task 2—Prepare Updated Detailed Work Plan for Developing the Guide for Pavement Friction.
- Task 3—Prepare Interim Report.

Phase II

- Task 4—Execute Approved Work Plan
 - Subtask 4a—Refine and Further Develop Basics of Pavement Friction and Texture.
 - Subtask 4b—Develop Recommendations for Pavement Friction Management.
 - Subtask 4c—Develop Recommendations for Asphalt Pavement Friction Design, Construction, and Restoration.
 - Subtask 4d—Develop Recommendations for Concrete Pavement Friction Design, Construction, and Restoration.

- Subtask 4e—Develop Methods for Evaluating Impacts of Other Factors on Pavement Friction Design.
- Subtask 4f—Prepare Draft Guide.
- Subtask 4g—Prepare Revised Guide.
- Subtask 4h—Develop Training Materials.
- Task 5—Prepare Final Report.

The key deliverables for this study—the Guide and this final project report—were developed as individual, stand-alone documents.

OVERVIEW OF REPORT

This report is presented in seven chapters. Chapter 1 is this introduction. Chapter 2 discusses the effort of gathering information through an immense literature search, state surveys, and state and industry interviews. Chapter 3 describes the nature of the relationship between pavement friction and safety. Chapter 4 provides important background information on pavement friction and texture, including their definitions, the factors that affect them, and how each parameter is measured and reported.

Chapters 5 and 6 focus on the two most important aspects of the new Guide for Pavement Friction—friction management and friction design, respectively. Descriptions of the processes, activities, and technical matters associated with each function are provided in these chapters, along with the information, data, and ideas used to support the guidelines featured in the Guide. The final chapter summarizes the key findings of this research study and presents the study recommendations.

Five appendices are also included in this report. Appendix A is a bibliography that lists all of the documents obtained and reviewed in Task 1. Appendix B contains the six-page questionnaire survey administered to state highway agencies (SHAs). Appendix C presents a summary of the state survey responses. Appendix D provides a summary of the results of interviews with selected states and industry organizations. And, appendix E is a primer on the fundamental concepts of pavement friction.

This page intentionally left blank.

CHAPTER 2. INFORMATION GATHERING

INTRODUCTION

As a basis for developing the new Guide for Pavement Friction, a tremendous amount of information related to pavement friction was collected, reviewed, and analyzed throughout the study. The information was obtained through three different means: (1) a detailed literature search, (2) a survey of SHAs, and (3) interviews with key representatives of selected states and industry organizations.

This chapter discusses the information gathering effort, including the types of information sought and collected, the sources targeted, and the process for compiling and storing the information. Chapters 3 through 6 expand upon key information and insight from the literature, surveys, and interviews.

LITERATURE SEARCH

The literature search focused primarily on information pertaining to pavement friction, texture, and other related surface characteristics. Also targeted in the search was information on user safety, as impacted by deficiencies in pavement friction, and economic considerations in the design of pavements with adequate friction.

The literature search was national and international in scope and was performed primarily via the Internet and through manual searches of the libraries, files, and other resource materials of the individual project team members. The library systems of the University of Illinois, Pennsylvania Transportation Institute of the Pennsylvania State (Penn State) University, U.S. Army Corps of Engineers Waterways Experiment Station (WES), and the National Aeronautics and Space Administration (NASA) were also utilized. These sources provided a wealth of publications ranging from historical documents to many recent publications.

Among the key sources tapped in the literature search were the following:

- Transportation Research Information Service (TRIS).
- National Technical Information Service (NTIS).
- National Transportation Library (NTL).
- Transportation Research Board (TRB).
- American Association of State Highway and Transportation Officials (AASHTO).
- Federal Highway Administration (FHWA).
- State Department of Transportation (DOT) research libraries.
- National Asphalt Pavement Association (NAPA).
- The Asphalt Institute.
- Association of Asphalt Paving Technologists (AAPT).
- National Center for Asphalt Technology (NCAT).
- American Concrete Pavement Association (ACPA).

- Portland Cement Association (PCA).
- American Concrete Institute (ACI).
- Innovative Pavement Research Foundation (IPRF).
- American Society for Testing and Materials (ASTM).
- International Standards Organization (ISO).
- American Society of Civil Engineers (ASCE).
- Foundation for Pavement Preservation (FP²).
- Transportation Association of Canada (TAC).
- International Road Federation (IRF).
- World Road Association (PIARC).

Over 600 documents were identified as potentially useful to the study. Of these, approximately 350 were obtained in either electronic or hardcopy form to serve as resource materials for developing the Guide. Each of these selected documents was catalogued and fully reviewed. Appendix A contains a bibliography of the collected documents.

STATE FRICTION SURVEY

To determine the state-of-the-practice regarding the evaluation and design of pavement friction, texture, and noise, a six-page questionnaire survey was developed and distributed to all SHAs in the U.S., as well as Puerto Rico and Washington D.C. The survey, which consisted of 33 questions on the following major topics, was sent to the TRB representative within each agency, where it was forwarded to the appropriate individuals (i.e., research, materials, or design personnel) for completion:

- Agency's protocols/procedures and equipment used to measure pavement surface friction, pavement surface texture, and pavement–tire noise.
- Design and construction standards (including material specifications, tests, and rehabilitation treatments) for ensuring high-friction, low-noise pavements (new and restored).
- Information concerning how agencies address safety issues related to pavement surface friction/texture and crash rates.

Forty-five completed responses were received; the responding agencies are highlighted on the map in figure 1.

The questionnaire survey is provided in appendix B. A summary of the responses is provided in appendix C.

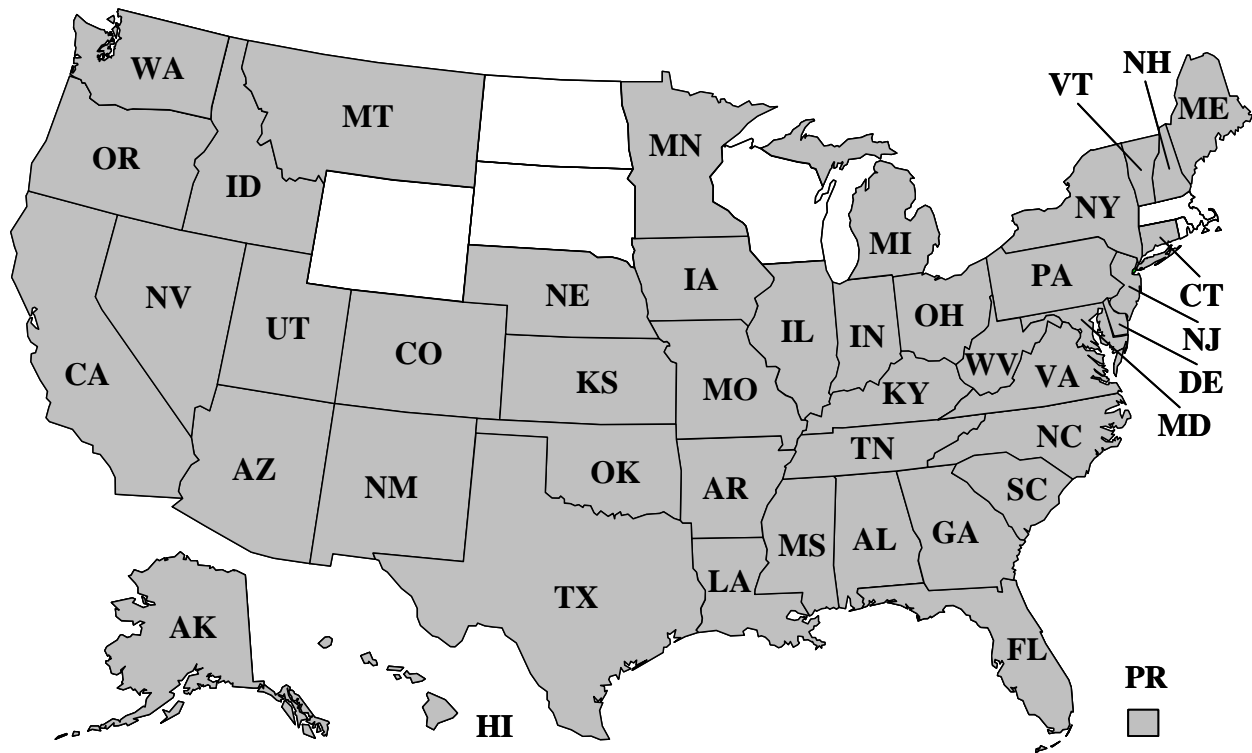

Figure 1. Agencies participating in the project survey.

STATE AND INDUSTRY INTERVIEWS

To supplement the information obtained from the literature search and surveys, a series of phone interviews were conducted with representatives of selected states and industry organizations. The representatives chosen were recognized as leading experts and practitioners in the pavement surface characteristics field.

One or more representatives were contacted and interviewed at the following state agencies:

- Arizona DOT.
- California DOT.
- Florida DOT.
- Georgia DOT.
- Illinois DOT.
- Louisiana Department of Transportation and Development (DOTD).
- Michigan DOT.
- New York State DOT.
- Texas DOT.
- Virginia DOT.
- Washington State DOT.

Representatives of paving associations, truck manufacturers, tire manufacturers, equipment manufacturers, and others were also contacted and interviewed. These included representatives from the following organizations:

- ACPA.
- NAPA.
- California Chip Seal Association (CCSA).
- Rubber Manufacturers Association (RMA).
- International Grinding and Grooving Association (IGGA).
- Mack Trucks.
- Kenworth Truck Company.
- Volvo North America Group.
- International Cybernetics Corporation.
- Dynatest Consulting.
- Texas Transportation Institute (TTI).
- Transportation Research Center (TRC).
- N.V. Robuco of Belgium.

To the extent possible or practical, each interview attempted to address the following nine important aspects of pavement friction:

- Friction management.
- Friction testing.
- Determining friction demand.
- Pavement surface selection and design.
- Pavement construction.
- Economic considerations.
- Noise-related issues.
- Suggested improvements to friction practices and desired areas of friction guidance.

A substantial amount of information was obtained from these interviews, and the details of each discussion were fully documented in interview memoranda. A summary of the interview results is provided in appendix D.

CHAPTER 3. PAVEMENT FRICTION AND HIGHWAY SAFETY

HIGHWAY SAFETY

Safety, as a general term, is often defined in two ways—the quality or condition of being safe (i.e., freedom from danger, injury, or damage) or any of certain devices or actions designed to prevent a crash from happening. Thus, it stands to reason that highway safety can be characterized as a driving environment free from danger or, more appropriately, one that is operated with rules and features designed to minimize crashes and the associated consequences (fatalities, injuries, economic loss).

Since the early years of motor vehicle transportation, governmental agencies and industry groups have worked continuously to institute highway safety measures. Over the past few decades, however, the societal demand for mobility and economic growth has increased substantially, resulting in spiraling rates of vehicle travel and unprecedented levels of risk for highway users.

Between 1990 and 2003, an average of 6.4 million highway crashes (all vehicle types) occurred annually on the nation's highways, resulting in 3 million injuries, 42,000 fatalities, and countless amounts of pain and suffering. This rate of fatality equates to 115 fatalities per day, or 1 death every 12 minutes (Noyce et al., 2005; National Highway Traffic Safety Administration [NHTSA], 2004).

Crashes occur at significant cost to the nation's economy. In 2000, the cost of highway crashes was estimated at \$230.6 billion (Noyce et al., 2005; NHTSA, 2004). This figure continues to increase year after year, taking up resources that could be used to improve the highway infrastructure.

Figures 2 and 3 present summaries of total crashes and resulting fatalities in the U.S. between 1990 and 2003. According to the National Transportation Safety Board (NTSB) and the FHWA, approximately 13.5 percent of fatal crashes and 25 percent of all crashes occur when pavements are wet (Kuemmel et al., 2000).

Highway crashes are complex events that are the result of one or more contributing factors. Such factors fall under three main categories—driver-related, vehicle-related, and highway condition-related (Noyce et al., 2005). Of these three categories, highway agencies can control only highway conditions. This can be done by developing and administering effective design, construction, maintenance, and management practices and policies.

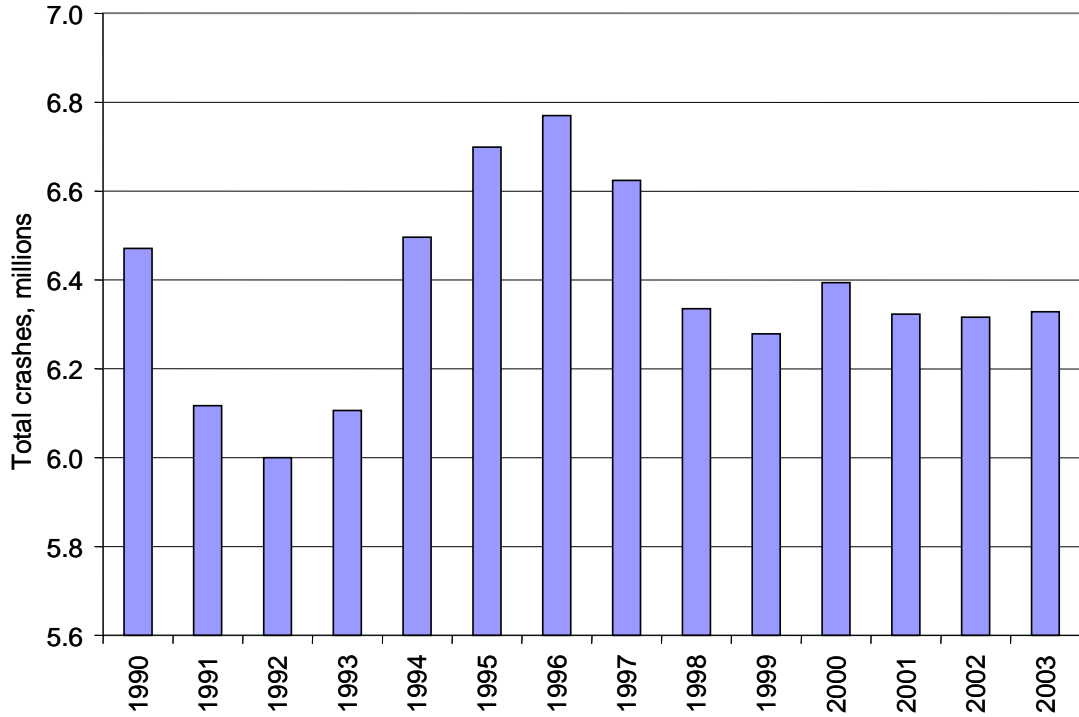

Figure 2. Total crashes (from all vehicles types) on U.S. highways from 1990 to 2003 (NHTSA, 2004).

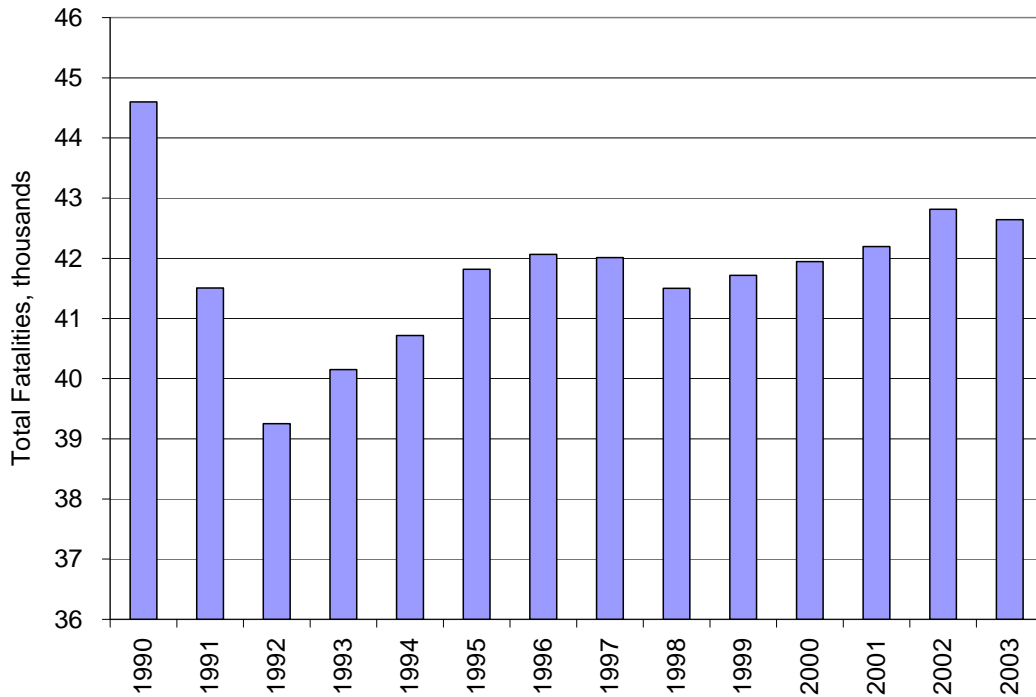

Figure 3. Total fatalities (from all vehicles types) on U.S. highways from 1990 to 2003 (NHTSA, 2004).

RELATIONSHIP BETWEEN WET-WEATHER CRASHES AND HIGHWAY PAVEMENT SURFACE CONDITIONS

Although most highway crashes involve multiple causative factors, crash investigations have consistently shown a link between crashes and pavement surface conditions/ characteristics, such as friction and texture. Thus, there is a need for in-depth knowledge and understanding of the relationship between the two so that engineers can develop effective solutions to potentially hazardous situations.

Wet-Weather Crashes and Pavement Friction

While the exact relationship between wet-weather crashes and pavement friction is difficult to quantify, much empirical research has been done that shows that the number of wet crashes increases as pavement friction decreases (all other factors, such as speed and traffic volume, remaining the same). A summary of the many published research findings is presented below.

- Rizenbergs et al., 1972—In this study, crash and measured pavement friction data obtained from mostly rural interstates and parkway roadways in Kentucky were analyzed. The results of the analysis showed increased wet crash rates at pavement friction values (*SN40R*, skid/friction number determined with a locked-wheel friction tester operated at 40 mi/hr [64 km/hr]) less than 40 for low and moderate traffic levels (see figure 4). Similar trends were observed when analyzing wet-to-dry crash ratios as a function of pavement friction, as shown in figure 5.
- Giles et al., 1962; Cairney, 1997—Pavement friction was evaluated at 120 sites where a skid-related crash had occurred along with a 100 randomly chosen control sites on highways of similar functional class and traffic volumes. The relative risk of a site being a skid-related crash site was computed by dividing the proportion of skid-related crash sites by the proportion of control sites for different pavement friction categories. The risk of a skid-related crash was small for friction values (*SN*) above 60, but increased rapidly for friction values below 50.
- McCullough and Hankins, 1966—In a study of the relationship between pavement friction and crashes from 571 sites in Texas, it was found that a large proportion of crashes occurred with low pavement friction and relatively few occurred with high pavement friction. A minimum desirable friction coefficient of 0.40 measured at 30 mi/hr (48 km/hr) was recommended. This value was obtained as a convenient value close to the point where the slope of crash rate versus friction decreased significantly.

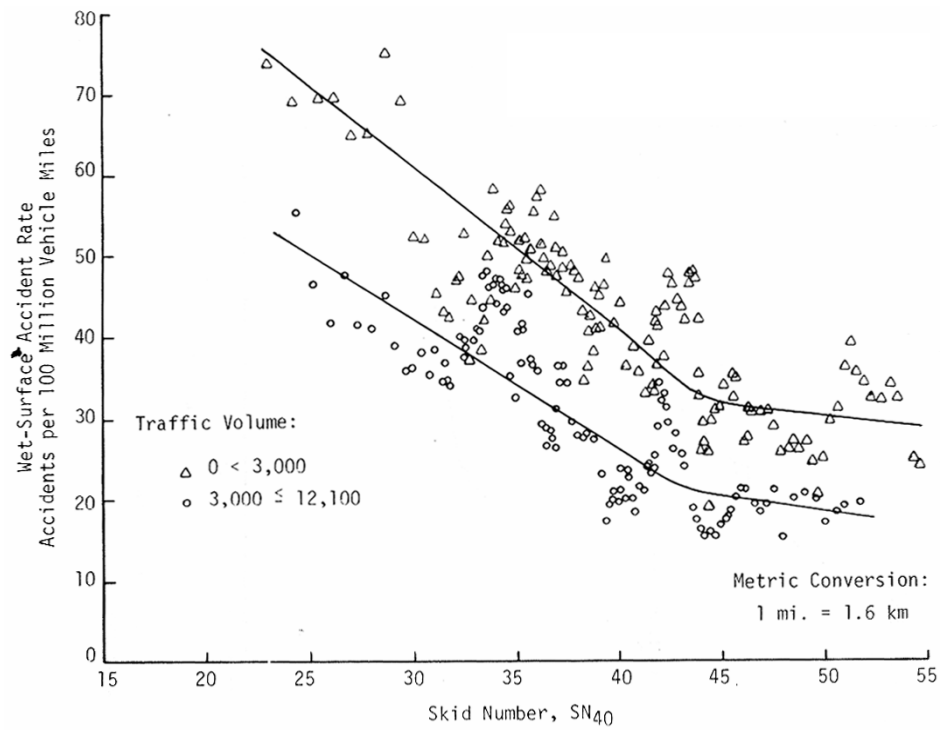

Figure 4. Relationship between wet-weather crash rates and pavement friction for Kentucky highways (Rizenbergs et al., 1973).

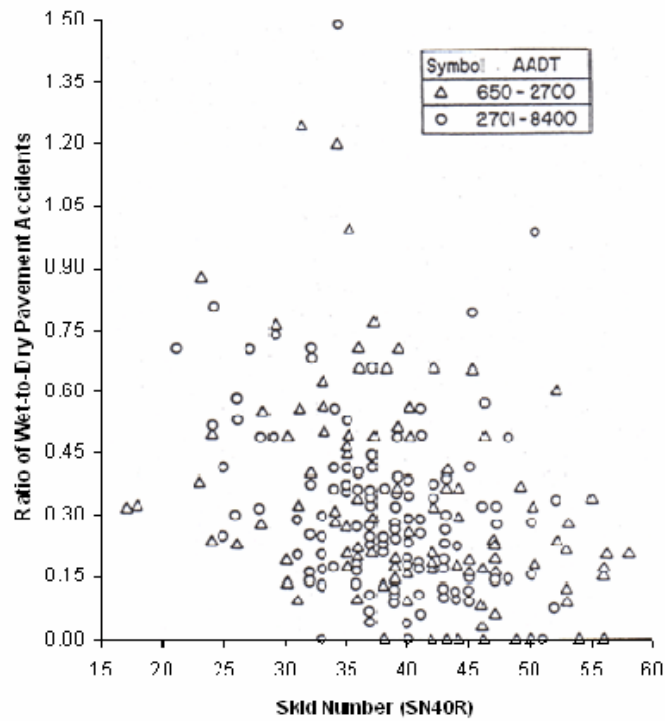

Figure 5. Ratio of wet-to-dry pavement crashes versus pavement friction for Kentucky highways (Rizenbergs et al., 1973).

- Miller and Johnson, 1973; Cairney, 1997—Available friction before and after resurfacing was determined on the M4 highway in England (i.e., resurfacing increased the average friction from 0.40 to 0.55, at 50 mi/hr [80 km/hr]). Crashes were recorded for 2 years before and 2 years after resurfacing, for a total of over 500 incidents. Data from this study showed that pavement resurfacing (increased pavement friction) resulted in a 28 percent reduction in dry pavement crashes and a 63 percent reduction in wet pavement crashes. Total crashes for the study area were reduced by 45 percent.
- Kamel and Gartshore, 1982—Selected hazardous sections (i.e., sections with low friction levels experiencing a high rate of wet pavement crashes) on the highway network in Ontario, Canada were resurfaced to increase pavement friction. For intersections, crashes were reduced by 46 percent overall, 21 percent in dry conditions and 71 percent in wet conditions. For freeways, total crashes were reduced by 29 percent, 16 percent in dry conditions and 54 percent in wet conditions.
- Gothie, 1996—Three separate studies were performed to define the cause-and-effect relationships between highway surface properties. The following was concluded: (1) wet crash rates increased by at least 50 percent when moving from a section with a Sideway Force Coefficient (SFC) greater than 0.60 to a section with an SFC less than 0.50, (2) for a reduction in SFC of 0.05, the risk and severity of crashes increased by approximately 50 percent.
- Bray, 2002—In this study, 40 pavement sections experiencing unusually high amounts of wet crashes were identified. Before and after hot mix asphalt (HMA) resurfacing (increased pavement friction) crash analyses showed significant reductions in the 740 recurring crashes (from which 540 were wet surface crashes) after rehabilitation.
- McLean, 1995—Before and after evaluation of resurfacing projects in England indicated that crash rates on rural highways can increase even when pavement friction is improved significantly. This finding implies that the gains from improved friction can be offset by the increased risk caused by improved ride quality (i.e., drivers tend to use smooth roads more often than rough ones, and they tend to travel at higher speeds).
- Organization for Economic Cooperation and Development (OECD), 1984—The OECD's International Scientific Expert Group on Optimizing Road Surface Characteristics revealed a linear crash-friction relationship in the U.S. (i.e., reduction in friction was associated with a linear increase in crashes). This behavioral function differs from other relationships obtained in Europe, where research suggests a non-linear relationship between pavement friction and crashes.
- Wallman and Astrom, 2001—In this research, a comprehensive evaluation of friction measurements and crash rates revealed that increasing pavement friction does reduce crash rates significantly, as summarized below.

<u>Friction Interval</u>	<u>Crash Rate (injuries per million vehicle km)</u>
< 0.15	0.80
0.15 – 0.24	0.55
0.25 – 0.34	0.25
0.35 – 0.44	0.20

- Gandhi et al., 1991—In the early 1990s, a study conducted in Puerto Rico found a statistically significant relationship between the minimum Mu-Meter skid number and the ratio of wet-to-dry crashes. Using linear regression, an R-squared value of 0.55 was obtained for those two variables. Other dependent variables considered included the ratio of wet crashes to the total number of crashes. The average friction coefficient in a section was found to be related less to crash rates than to the minimum friction coefficient.
- Craus et al., 1991—This study was conducted by the Israeli Public Works Department to examine the relationship between pavement frictional condition measured by a Mu-Meter and highway crashes. It was found that average Mu-Meter readings greater than 37 for the network could reduce the total number of crashes by 7.5 percent.
- Larson, 1999—French research reported in 1996 found a five-fold increase in the wet crash rates on the Bordeaux Ring Road when the SFC decreased from greater than 0.60 to less than 0.50. This study also found that the risk of wet crashes increases greatly for surfaces with an estimated texture depth less than 0.016 in (0.40 mm).
- Xiao et al., 2000—Researchers at the Pennsylvania Transportation Institute (PTI) developed two fuzzy logic models to predict wet-pavement crashes. The skid number, posted speed, average daily traffic (ADT), pavement wet time, and driving difficulty were the variables selected as having the greatest effect on the risk of skidding crashes at a site. These models were used to calculate the improvement in safety expected from improvements in each of the input variables. It was shown that the safety condition, measured by the percent reduction in wet pavement crashes, could be improved nearly 60 percent if the skid number increased from 33.4 to 48.
- Schulze et al., 1976—The effect of wet climate on safety was further demonstrated by a study conducted in Germany, where the proportion of wet crashes was compared to pavement surface friction, as shown in figure 6. Friction number for this study was measured at 50 mi/hr (80 km/hr). Although there was a large scatter in the data, this figure clearly shows there is a significant increase in wet pavement crashes as the pavement friction decreases.

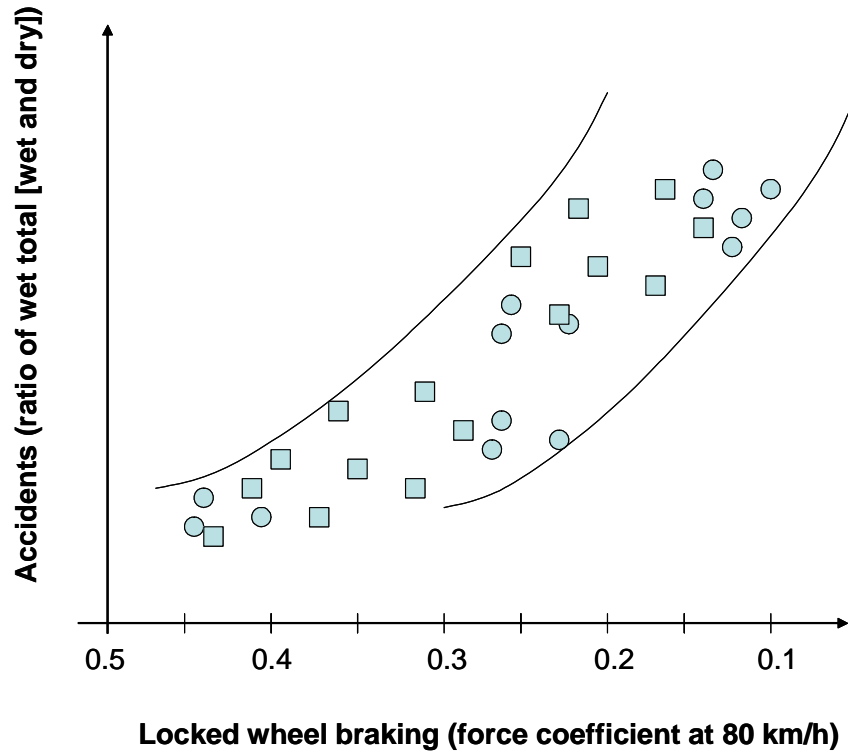

Figure 6. Relationship between wet crashes and pavement surface friction (Schulze et al., 1976).

Empirical evidence from these research studies shows that vehicle crashes are more likely to occur on wet pavements (with lower friction levels) and that, as pavement friction levels decrease, there is a corresponding increase in crash rates. Research also shows that when pavement friction falls below a site-specific threshold value, the risk of wet crashes increases significantly (Kuttesch, 2004).

The exact nature of the relationship between pavement friction and wet crashes is site-specific, as it defined by not only pavement friction but many others factors. Thus, pavement friction and wet crashes relationships must be developed for the sites that are typically present in a given pavement network. An example of such a relationship developed for single carriageways in the U.K. shows that crash risk approximately halves as pavement friction doubles over normal ranges, as shown in figure 7 (Viner et al., 2004).

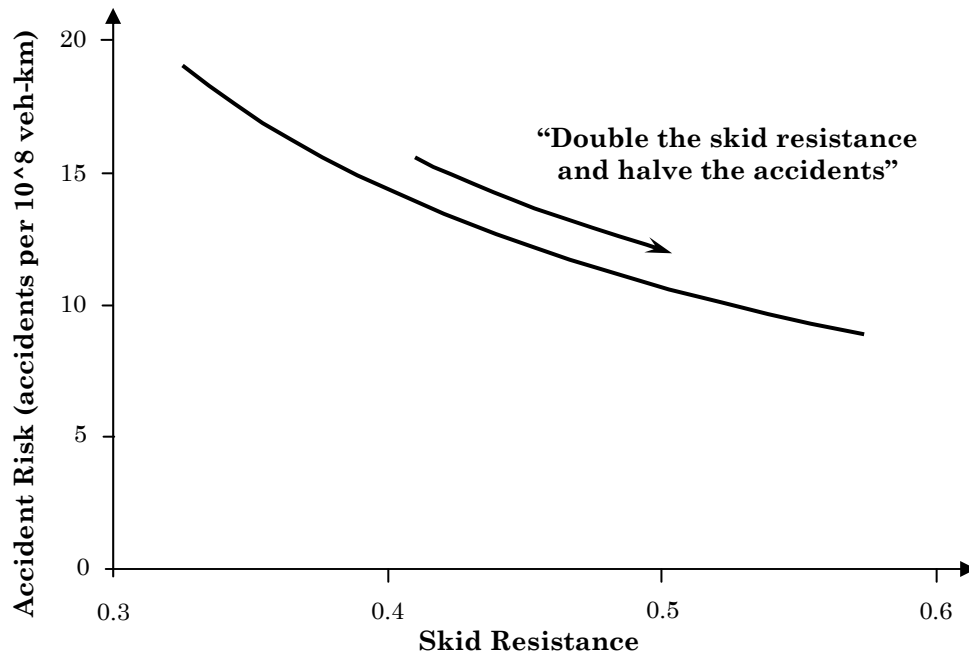

Figure 7. Relationship between pavement friction and crash risk (Viner et al., 2004).

Wet-Weather Crashes and Splash/Spray

“Splash” and “spray” describe vehicle-induced water droplets and mist that adversely affect driver visibility on wet highways. Splash consists of very large liquid droplets that fall ballistically to the ground, while spray consists of very small liquid droplets that remain in the air for a long time in the form of a fog cloud before falling to the ground (NHTSA, 1998). Conditions that most favor the spray and must be present for it to occur are: (1) standing water, (2) a hard or smooth surface struck by the water, and (3) a turbulent airflow to pick up and carry the water (NHTSA, 1998).

Splash does not significantly influence driver visibility, as the splashed droplets typically remain close to the ground and out of the line of the driver's vision. However, because spray can remain airborne for a long time, it can surprise, confuse, and disorientate drivers (NHTSA, 1998), leading potentially to the hazards listed in table 1.

Although it is accepted that splash and spray increase crash risk, there is very limited information on how many of the crashes that occur on the nation’s highways are a direct result of splash and spray. A review of federal and state crash-related databases indicates that most agencies do not collect sufficiently detailed information to assign specific cause to splash and/or spray.

Table 1. List of hazards that can potentially be caused by splash and spray (NHTSA, 1998).

Potential Hazard Target	Description
Lead vehicle	Spray obscures following vehicles.
Follower	Spray from lead vehicles obscures visibility of lead vehicles, signs, edge lines, other traffic at intersections, traffic signals.
Follower	Doused during passing, lane change.
Opposing vehicles (2 lanes are adjacent)	Spray obscures visibility of vehicles in passing lane; spray obscures lead vehicles, signs, edge lines, other traffic at intersections, traffic signals (in own lane).
	Doused during encounter causes loss of control.
Opposing vehicles (divided highways)	Spray drift from vehicle in opposing lanes obscures visibility of lead vehicles, signs, edge lines, other traffic at intersections, traffic signals.
Motorcycles, cyclists, and pedestrians	Numerous visibility problems.
	Knowing they cannot be seen, they navigate differently.
	Doused when vehicle passes.

Upon reviewing data from the Fatality Analysis Reporting System (FARS) and the National Automotive Sampling System (NASS) General Estimates System (GES), the University of Michigan Transportation Research Institute (UMTRI) reported the following (NHTSA, 1998; NHTSA, 2005):

- FARS identified 29 splash- and spray-related crashes out of a total of 255,928 reported from 1991 through 1997 (i.e., approximately 0.011 percent of all crashes were identified as having splash or spray as a contributing factor). This rate is somewhat higher than the rate from the FARS for 1982 through 1987, as reported in the 1994 Report to Congress. Nevertheless, the percentage of crashes attributed to splash and spray is too small to have any significance. Of the 29 crashes reported in FARS, only one involved a truck.
- In the GES records, a total of 17 crashes were recorded between 1991 and 1997. This translates into a weighted estimated total of 1,622 splash/spray-related crashes occurring for this period (i.e., 0.0036 percent of the total of 45,024,000 crashes estimated to have occurred over those 8 years).

Thus, the information available in both FARS and GES indicates that the number of recorded splash/spray crashes is extremely small and may not be a significant contributor to highway crashes. However, when it occurs, it is not limited to high-speed highways with a high percentage of truck traffic, and there is sufficient empirical information to suggest that a puddle in the middle of a highway can initiate the process that results in a splash- or spray-related crash.

This page intentionally left blank.

CHAPTER 4. PAVEMENT FRICTION AND SURFACE TEXTURE

PAVEMENT FRICTION

Definition

Pavement friction is the force that resists the relative motion between a vehicle tire and a pavement surface. This resistive force, illustrated in figure 8, is generated as the tire rolls or slides over the pavement surface.

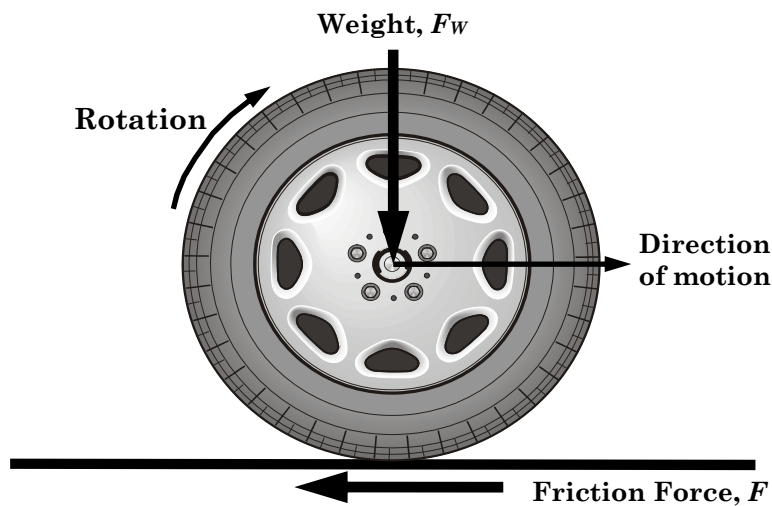

Figure 8. Simplified diagram of forces acting on a rotating wheel.

The resistive force, characterized using the non-dimensional friction coefficient, μ , is the ratio of the tangential friction force (F) between the tire tread rubber and the horizontal traveled surface to the perpendicular force or vertical load (F_w) and is computed using equation 1.

$$\mu = \frac{F}{F_w} \quad \text{Eq. 1}$$

Pavement friction plays a vital role in keeping vehicles on the road, as it gives drivers the ability to control/maneuver their vehicles in a safe manner, in both the longitudinal and lateral directions. It is a key input for highway geometric design, as it is used in determining the adequacy of the minimum stopping sight distance, minimum horizontal radius, minimum radius of crest vertical curves, and maximum super-elevation in horizontal curves. Generally speaking, the higher the friction available at the pavement-tire interface, the more control the driver has over the vehicle.

Longitudinal Frictional Forces

Longitudinal frictional forces occur between a rolling pneumatic tire (in the longitudinal direction) and the road surface when operating in the free rolling or constant-braked mode. In the free-rolling mode (no braking), the relative speed between the tire circumference and the pavement—referred to as the slip speed—is zero. In the constant-braked mode, the slip speed increases from zero to a potential maximum of the speed of the vehicle. The following mathematical relationship explains slip speed (Meyer, 1982):

$$S = V - V_p = V - (0.68 \times \omega \times r) \quad \text{Eq. 2}$$

where: S = Slip speed, mi/hr.
 V = Vehicle speed, mi/hr.
 V_p = Average peripheral speed of the tire, mi/hr.
 ω = Angular velocity of the tire, radians/sec.
 r = Average radius of the tire, ft.

Again, during the free-rolling state of the tire, V_p is equal to the vehicle speed; thus, S is zero. For a locked or fully braked wheel, V_p is zero, so the sliding speed or slip speed is equal to the vehicle speed (V). A locked-wheel state is often referred to as a 100 percent slip ratio, and the free-rolling state is a zero percent slip ratio. The following mathematical relationships give the calculation formula for slip ratio (Meyer, 1982):

$$SR = \frac{V - V_p}{V} \times 100 = \frac{S}{V} \times 100 \quad \text{Eq. 3}$$

where: SR = Slip ratio, percent.
 V = Vehicle speed, mi/hr.
 V_p = Average peripheral speed of the tire, mi/hr.
 S = Slip speed, mi/hr.

Similar to the previous explanation, during the free-rolling state of the tire, V_p is equal to the vehicle speed and S is zero, thus the slip ratio (SR) is zero percent. For a locked wheel, V_p is zero, S equals the vehicle speed (V), and so the slip ratio (SR) is 100 percent.

Figure 9 shows the ground force acting on a free rolling tire. In this mode, the ground force is at the center of pressure of the tire contact area and is off center by the amount a . This offset causes a moment that must be overcome to rotate the tire. The force required to counter this moment is called the rolling resistance force (F_R). The value a is a function of speed and increases with speed. Thus, F_R increases with speed.

In the constant-braked mode (figure 10), an additional force called the braking slip force (F_B) is required to counter the added moment (M_B) created by braking. The force is proportional to the level of braking and the resulting slip ratio. The total frictional force is the sum of the free-rolling resistance force (F_R) and the braking slip force (F_B).

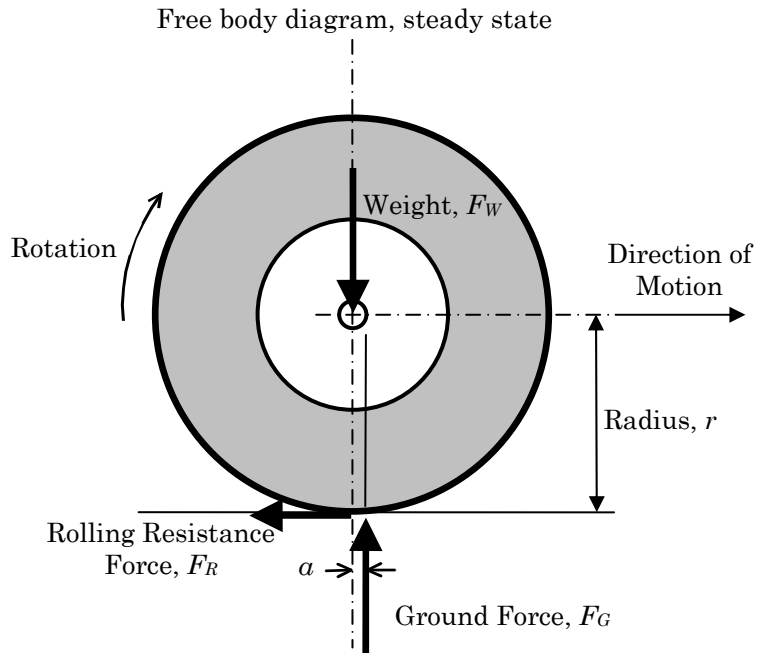

Figure 9. Rolling resistance force with a free-rolling tire at a constant speed on a bare, dry paved surface (Andresen and Wambold, 1999).

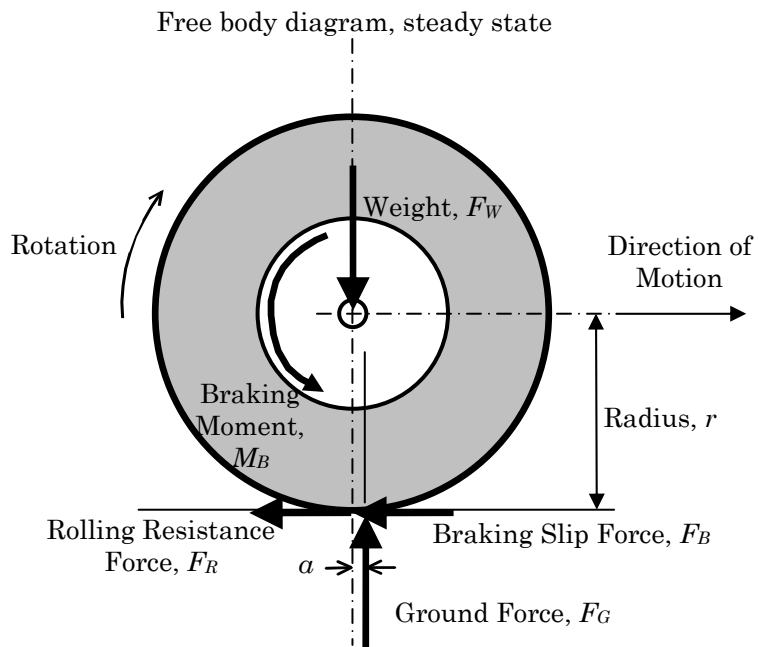

Figure 10. Forces and moments of a constant-braked wheel on a bare, dry paved surface (Andresen and Wambold, 1999).

The coefficient of friction between a tire and the pavement changes with varying slip, as shown in figure 11 (Henry, 2000). The coefficient of friction increases rapidly with increasing slip to a peak value that usually occurs between 10 and 20 percent slip (critical slip). The friction then decreases to a value known as the coefficient of sliding friction, which occurs at 100 percent slip. The difference between the peak and sliding coefficients of friction may equal up to 50 percent of the sliding value, and is much greater on wet pavements than on dry pavements.

The relationship shown in figure 11 is the basis for the anti-locking brake system (ABS), which takes advantage of the front side of peak friction and minimizes the loss of side/steering friction due to sliding action. Vehicles with ABS are designed to apply the brakes on and off (i.e., pump the brakes) repeatedly, such that the slip is held near the peak. The braking is turned off before the peak is reached and turned on at a set time or percent slip below the peak. The actual timing is a proprietary design of the manufacturer.

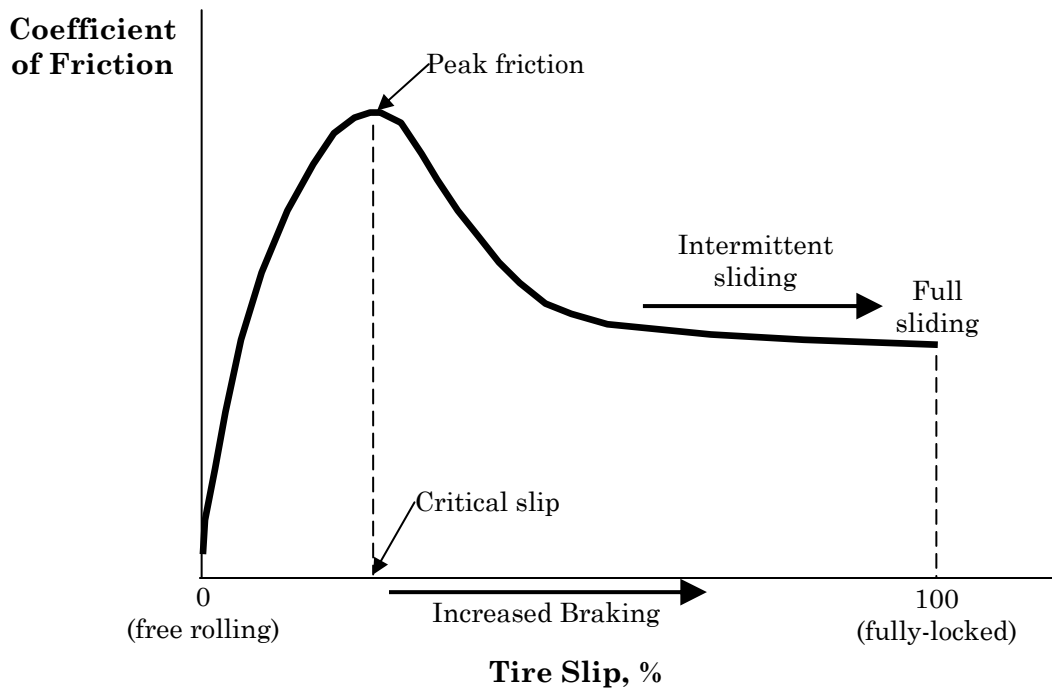

Figure 11. Pavement friction versus tire slip.

Lateral Frictional Forces

Another important aspect of friction relates to the lateral or side-force friction that occurs as a vehicle changes direction or compensates for pavement cross-slope and/or cross wind effects. The relationship between the forces acting on the vehicle tire and the pavement surface as the vehicle steers around a curve, changes lanes, or compensates for lateral forces is as follows:

$$F_s = \frac{V^2}{15R} - e \quad \text{Eq. 4}$$

- where: F_s = Side friction.
 V = Vehicle speed, mi/hr.
 R = Radius of the path of the vehicle's center of gravity (also, the radius of curvature in a curve), ft.
 e = Pavement super-elevation, ft/ft.

This equation is based on the pavement–tire steering/cornering force diagram in figure 12. It shows how the side-force friction factor acts as a counterbalance to the centripetal force developed as a vehicle performs a lateral movement.

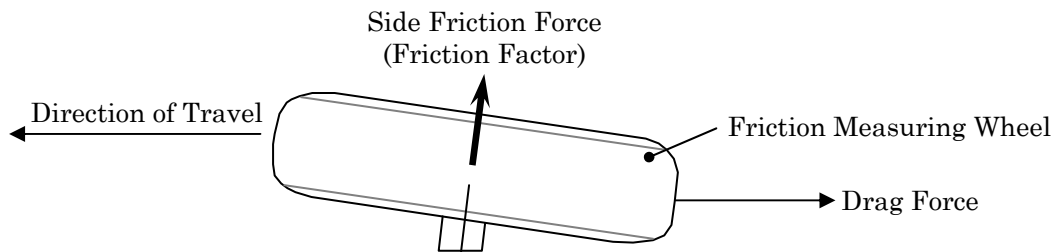
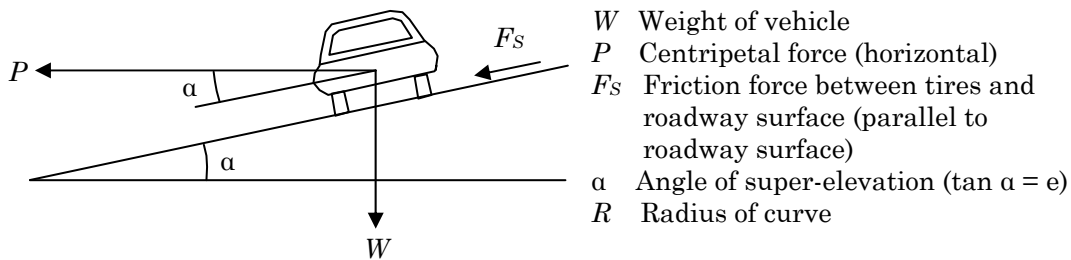

Figure 12. Dynamics of a vehicle traveling around a constant radius curve at a constant speed, and the forces acting on the rotating wheel.

Combined Braking and Cornering

With combined braking and cornering, a driver either risks not stopping as rapidly or losing control due to reduced lateral/side forces. When operating at the limits of tire grip, the interaction of the longitudinal and lateral forces is such that as one force increases, the other must decrease by a proportional amount. The application of longitudinal braking reduces the lateral force significantly. Similarly, the application of high lateral force reduces the longitudinal braking. Figure 13 shows these effects (Gillespie, 1992).

Commonly referred to as the friction circle or friction ellipse (Radt and Milliken, 1960), the vector sum of the two combined forces remains constant (circle) or near constant (ellipse) (see figure 14). When operating within the limits of tire grip, the amount of braking and turning friction components can vary independently as long as the vector sum of these components does not exceed the limits of tire grip as defined by the friction circle or friction ellipse. The degree of ellipse depends on the tire and pavement properties.

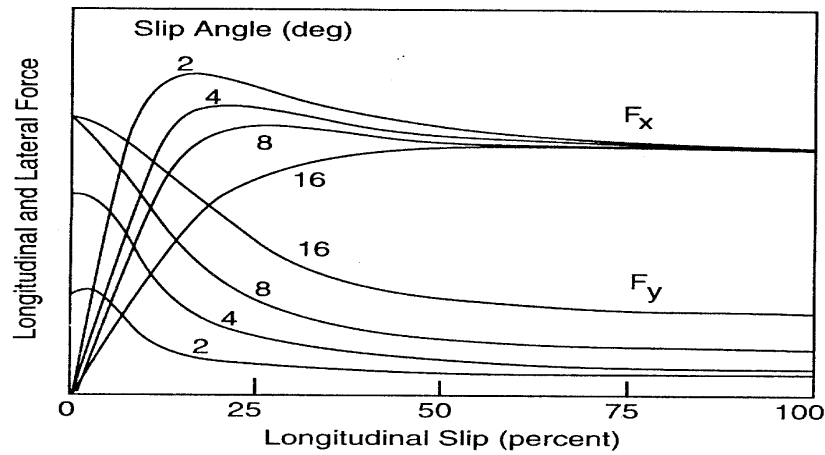

Figure 13. Brake (F_x) and lateral (F_y) forces as a function of longitudinal slip (Gillespie, 1992).

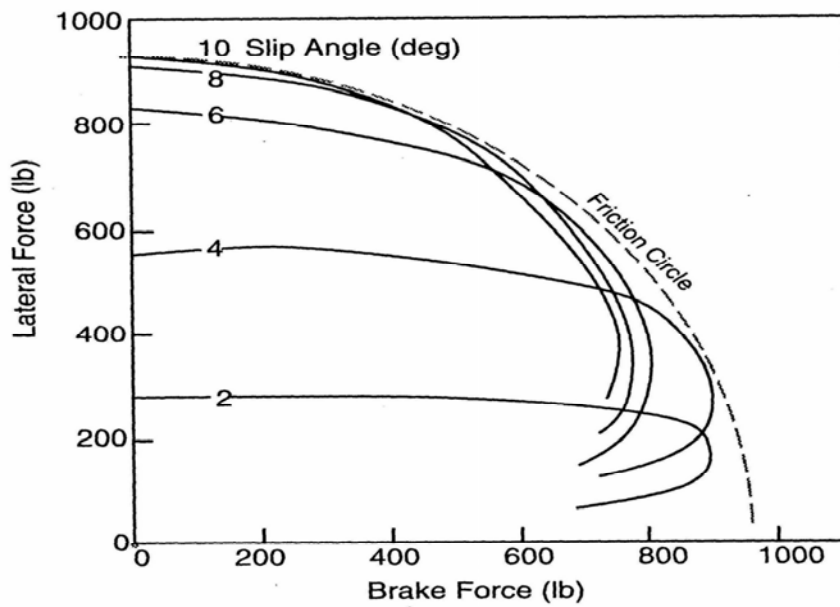

Figure 14. Lateral force versus longitudinal force at constant slip angles (Gillespie, 1992).

Friction Mechanisms

Pavement friction is the result of a complex interplay between two principal frictional force components—adhesion and hysteresis (figure 15). Adhesion is the friction that results from the small-scale bonding/interlocking of the vehicle tire rubber and the pavement surface as they come into contact with each other. It is a function of the interface shear strength and contact area. The hysteresis component of frictional forces results from the energy loss due

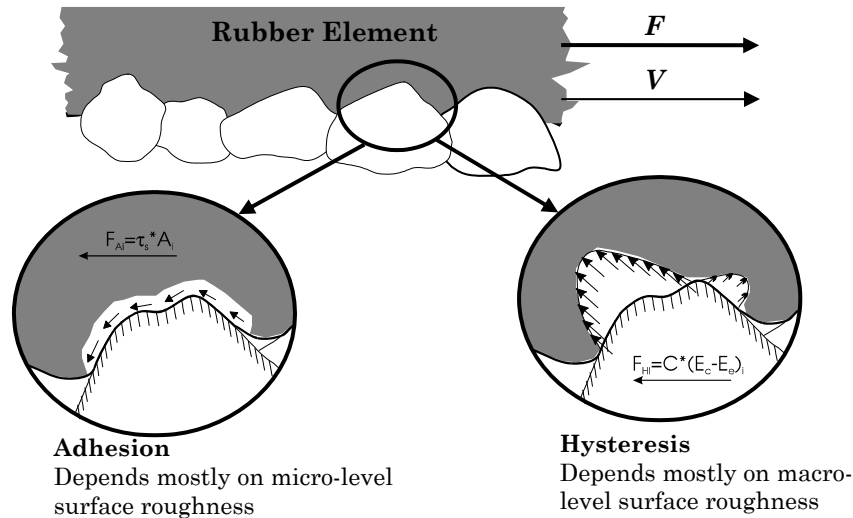

Figure 15. Key mechanisms of pavement–tire friction.

to bulk deformation of the vehicle tire. The deformation is commonly referred to as enveloping of the tire around the texture. When a tire compresses against the pavement surface, the stress distribution causes the deformation energy to be stored within the rubber. As the tire relaxes, part of the stored energy is recovered, while the other part is lost in the form of heat (hysteresis), which is irreversible. That loss leaves a net frictional force to help stop the forward motion.

Although there are other components of pavement friction (e.g., tire rubber shear), they are insignificant when compared to the adhesion and hysteresis force components. Thus, friction can be viewed as the sum of the adhesion and hysteresis frictional forces.

$$F = F_A + F_H \quad \text{Eq. 5}$$

Both components depend largely on pavement surface characteristics, the contact between tire and pavement, and the properties of the tire. Also, because tire rubber is a visco-elastic material, temperature and sliding speed affect both components.

Because adhesion force is developed at the pavement–tire interface, it is most responsive to the micro-level asperities (micro-texture) of the aggregate particles contained in the pavement surface. In contrast, the hysteresis force developed within the tire is most responsive to the macro-level asperities (macro-texture) formed in the surface via mix design and/or construction techniques. As a result of this phenomenon, adhesion governs the overall friction on smooth-textured and dry pavements, while hysteresis is the dominant component on wet and rough-textured pavements.

Factors Affecting Available Pavement Friction

The factors that influence pavement friction forces can be grouped into four categories—pavement surface characteristics, vehicle operational parameters, tire properties, and environmental factors. Table 2 lists the various factors comprising each category. Because each factor in this table plays a role in defining pavement friction, friction must be viewed as a process instead of an inherent property of the pavement. It is only when all these factors are fully specified that friction takes on a definite value.

The more critical factors are shown in bold in table 2 and are briefly discussed below. Among these factors, the ones considered to be within a highway agency’s control are micro-texture and macro-texture, pavement materials properties, and slip speed.

Table 2. Factors affecting available pavement friction
(modified from Wallman and Astrom, 2001).

Pavement Surface Characteristics	Vehicle Operating Parameters	Tire Properties	Environment
<ul style="list-style-type: none"> • Micro-texture • Macro-texture • Mega-texture/ unevenness • Material properties • Temperature 	<ul style="list-style-type: none"> • Slip speed <ul style="list-style-type: none"> > Vehicle speed > Braking action • Driving maneuver <ul style="list-style-type: none"> > Turning > Overtaking 	<ul style="list-style-type: none"> • Foot Print • Tread design and condition • Rubber composition and hardness • Inflation pressure • Load • Temperature 	<ul style="list-style-type: none"> • Climate <ul style="list-style-type: none"> > Wind > Temperature > Water (rainfall, condensation) > Snow and Ice • Contaminants <ul style="list-style-type: none"> > Anti-skid material (salt, sand) > Dirt, mud, debris

Note: Critical factors are shown in bold.

Pavement Surface Characteristics

Surface Texture

Pavement surface texture is characterized by the asperities present in a pavement surface. Such asperities may range from the micro-level roughness contained in individual aggregate particles to a span of unevenness stretching several feet in length. The two levels of texture that predominantly affect friction are micro-texture and macro-texture (Henry, 2000).

As figure 16 shows, micro-texture is the degree of roughness imparted by individual aggregate particles, whereas macro-texture is the degree of roughness imparted by the deviations among particles. Micro-texture is mainly responsible for pavement friction at low speeds, whereas macro-texture is mainly responsible for reducing the potential for separation of tire and pavement surface due to hydroplaning and for inducing friction caused by hysteresis for vehicles traveling at high speeds. Further discussions on micro-texture and macro-texture are provided later in this chapter under the heading “Pavement Surface Texture.”

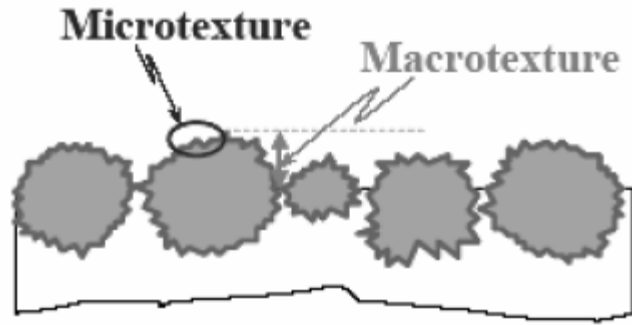

Figure 16. Micro-texture versus macro-texture (Flintsch et al., 2003).

Surface Material Properties

Pavement surface material properties (i.e., aggregate and mix characteristics, texturing patterns) help to define surface texture. These properties also affect the long-term durability of texture through their capacities to resist aggregate polishing and abrasion/wear of both aggregate and mix under accumulated traffic and environmental loadings.

Vehicle Operating Parameters

Slip Speed

The coefficient of friction between a tire and the pavement changes with varying slip. It increases rapidly with increasing slip to a peak value that usually occurs between 10 and 20 percent slip. The friction then decreases to a value known as the coefficient of sliding friction, which occurs at 100 percent slip.

Tire Properties

Tire Tread Design and Condition

Tire tread design (i.e., type, pattern, and depth) and condition have a significant influence on draining water that accumulates at the pavement surface. Water trapped between the pavement and the tire can be expelled through the channels provided by the pavement surface texture and by the tire tread. The depth of tread is particularly important for vehicles driving over thick films of water at high speeds. Some studies (Henry, 1983) have reported a decrease in wet friction of 45 to 70 percent for fully worn tires, compared to new ones.

Tire Inflation Pressure

Tire under-inflation can significantly reduce friction at high speeds. Under-inflated tires allow the center of the tire tread to collapse and become very concave, resulting in the constriction of drainage channels within the tire tread and a reduction of contact pressure.

The effect is for the tire to trap water at the pavement surface rather than allow it to flow through the treads. As a consequence, hydroplaning speed is decreased.

Tire over-inflation, on the other hand, causes only a small loss of pavement friction (Henry, 1983; Kulakowski et al., 1990). Over-inflated tires reduce the trapping effect and yield higher pressure for forcing water from below the vehicle's tire. The increased tire pressure and smaller tire contact area result in a higher hydroplaning speed.

Environment

Thermal Properties

Automotive tires are visco-elastic materials, and their properties can be significantly affected by changes in temperature and other thermal properties, such as thermal conductivity and specific heat. Research indicates that pavement-tire friction generally decreases with increasing tire temperature, though this is difficult to quantify.

Water

Water, in the form of rainfall or condensation, can act as a lubricant, significantly reducing the friction between tire and pavement. The effect of water film thickness (*WFT*) on friction is minimal at low speeds (<20 mi/hr [32 km/hr]) and quite pronounced at higher speeds (>40 mi/hr [64 km/hr]). As shown in figure 17, the coefficient of friction of a vehicle tire sliding over a wet pavement surface decreases exponentially as *WFT* increases. The rate at which the coefficient of friction decreases generally becomes smaller as *WFT* increases. In addition, the effect of *WFT* is influenced by tire design and condition, with worn tires being most sensitive to *WFT*.

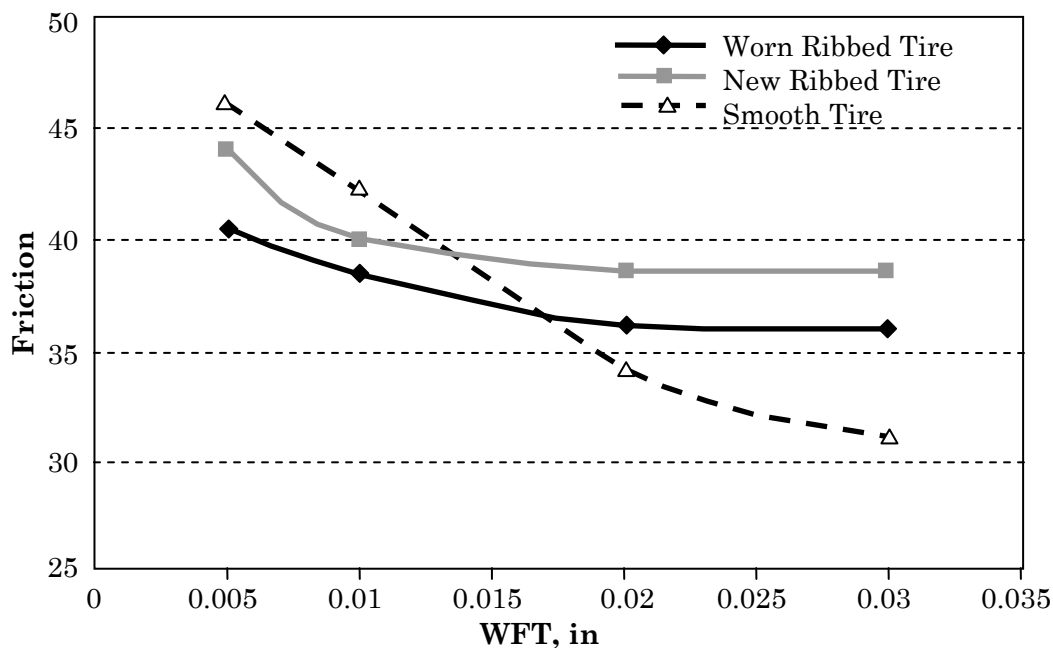

Figure 17. Effect of water film thickness on pavement friction (Henry, 2000).

A very small amount of water can significantly reduce pavement friction. Test results from an FHWA-sponsored study (Harwood, 1987) indicate that as little as 0.002 in (0.05 mm) of water on the pavement surface can reduce the coefficient of friction by 20 to 30 percent of the dry coefficient of friction. In some cases, a 0.001-in (0.025-mm) water film can reduce friction significantly. Such a thin film is likely to form during any hour in which at least 0.01 in (0.25 mm) of rain has fallen.

Hydroplaning can occur when relatively thick water layers or films are present and vehicles are traveling at higher speeds. Hydroplaning occurs when a vehicle tire is separated from the pavement surface by the water pressure that builds up at the pavement–tire interface (Horne and Buhlmann, 1983), causing friction to drop to a near-zero level. It is a complex phenomenon affected by several parameters, including water depth, vehicle speed, pavement macro-texture, tire tread depth, tire inflation pressure, and tire contact area.

Relatively thick water films form on a pavement surface when drainage is inadequate during heavy rainfalls or when pavement rutting or wearing creates puddles. Loss of direct pavement–tire contact can occur at speeds as low as 40 to 45 mi/hr (64 to 72 km/hr) on puddles about 1 in (25 mm) deep and 30 ft (9 m) long (Hayes et al., 1983).

Pavement macro-texture and tire tread depth influence the onset of dynamic hydroplaning in two ways. First, they have a direct effect on the critical hydroplaning speed because they provide a pathway for water to escape from the pavement–tire interface. Second, they have an indirect effect on the critical hydroplaning speed since the larger the macro-texture, the deeper the water must be to cause hydroplaning. However, the pavement surface must also have the proper micro-texture to develop adequate friction.

Snow and Ice

Snow and ice on the pavement surface present the most hazardous condition for vehicle braking or cornering. The level of friction between the tires and the pavement is such that almost any abrupt braking or sudden change of direction results in locked-wheel sliding and loss of vehicle directional stability. NCHRP Web Document 53 (Al Qadi et al., 2002) noted that vehicle friction performance can be drastically degraded if the tire contact area does not reach the pavement surface because of ice and snow.

Contaminants

Contaminants commonly found on highways include dirt, sand, oil, water, snow, and ice. Any kind of contamination at the pavement–tire interface will have an adverse effect on pavement–tire friction. Foreign materials act like the balls in a ball bearing, or as lubricant between a piston and cylinder in an engine, reducing friction between the two surfaces. The thicker or more viscous the contaminant, the greater the reduction in pavement–tire friction. The grinding effect of hard contaminants, such as sand, accelerates the rate of wearing at the pavement surface.

PAVEMENT SURFACE TEXTURE

Definition

Pavement surface texture is defined as the deviations of the pavement surface from a true planar surface. These deviations occur at three distinct levels of scale, each defined by the wavelength (λ) and peak-to-peak amplitude (A) of its components. The three levels of texture, as established in 1987 by the Permanent International Association of Road Congresses (PIARC), are as follows:

- Micro-texture ($\lambda < 0.02$ in [0.5 mm], $A = 0.04$ to 20 mils [1 to 500 μm])—Surface roughness quality at the sub-visible or microscopic level. It is a function of the surface properties of the aggregate particles contained in the asphalt or concrete paving material.
- Macro-texture ($\lambda = 0.02$ to 2 in [0.5 to 50 mm], $A = 0.005$ to 0.8 in [0.1 to 20 mm])—Surface roughness quality defined by the mixture properties (shape, size, and gradation of aggregate) of asphalt paving mixtures and the method of finishing/texturing (dragging, tining, grooving; depth, width, spacing and orientation of channels/grooves) used on a concrete paved surfaces.
- Mega-texture ($\lambda = 2$ to 20 in [50 to 500 mm], $A = 0.005$ to 2 in [0.1 to 50 mm])—Texture with wavelengths in the same order of size as the pavement–tire interface. It is largely defined by the distress, defects, or “waviness” on the pavement surface.

Wavelengths longer than the upper limit (20 in [500 mm]) of mega-texture are defined as roughness or unevenness (Henry, 2000). Figure 18 illustrates the three texture ranges, as well as a fourth level—roughness/unevenness—representing wavelengths longer than the upper limit (20 in [500 mm]) of mega-texture.

It is widely recognized that pavement surface texture influences many different pavement–tire interactions. Figure 19 shows the ranges of texture wavelengths affecting various vehicle–road interactions, including friction, interior and exterior noise, splash and spray, rolling resistance, and tire wear. As can be seen, friction is primarily affected by micro-texture and macro-texture, which correspond to the adhesion and hysteresis friction components, respectively.

Figure 20 shows the relative influences of micro-texture, macro-texture, and speed on pavement friction. As can be seen, micro-texture influences the magnitude of tire friction, while macro-texture impacts the friction–speed gradient. At low speeds, micro-texture dominates the wet and dry friction level. At higher speeds, the presence of high macro-texture facilitates the drainage of water so that the adhesive component of friction afforded by micro-texture is re-established by being above the water. Hysteresis increases with speed exponentially, and at speeds above 65 mi/hr (105 km/hr) accounts for over 95 percent of the friction (PIARC, 1987).

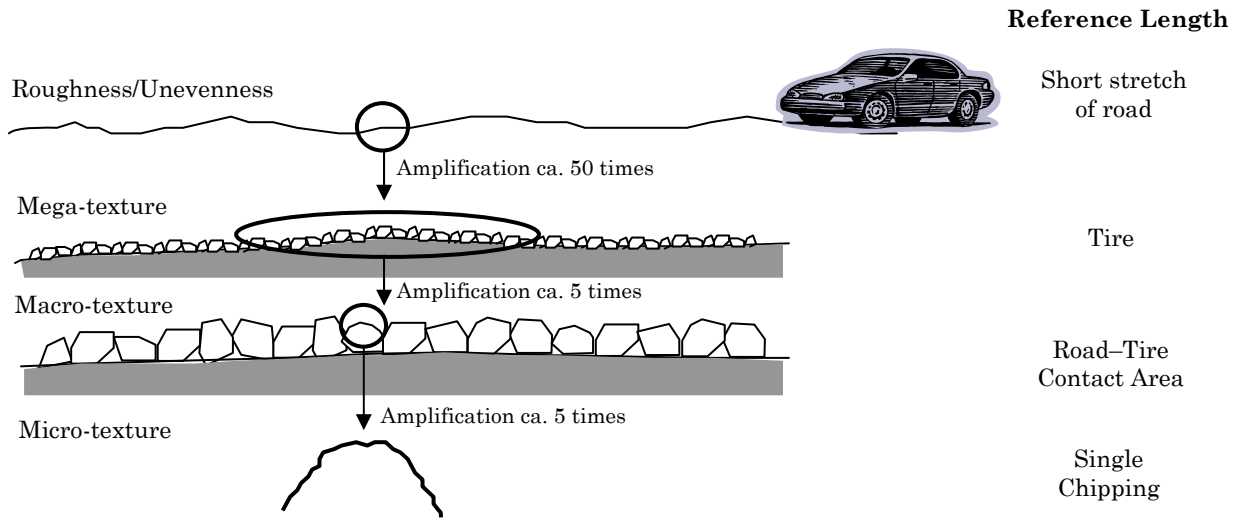

Figure 18. Simplified illustration of the various texture ranges that exist for a given pavement surface (Sandburg, 1998).

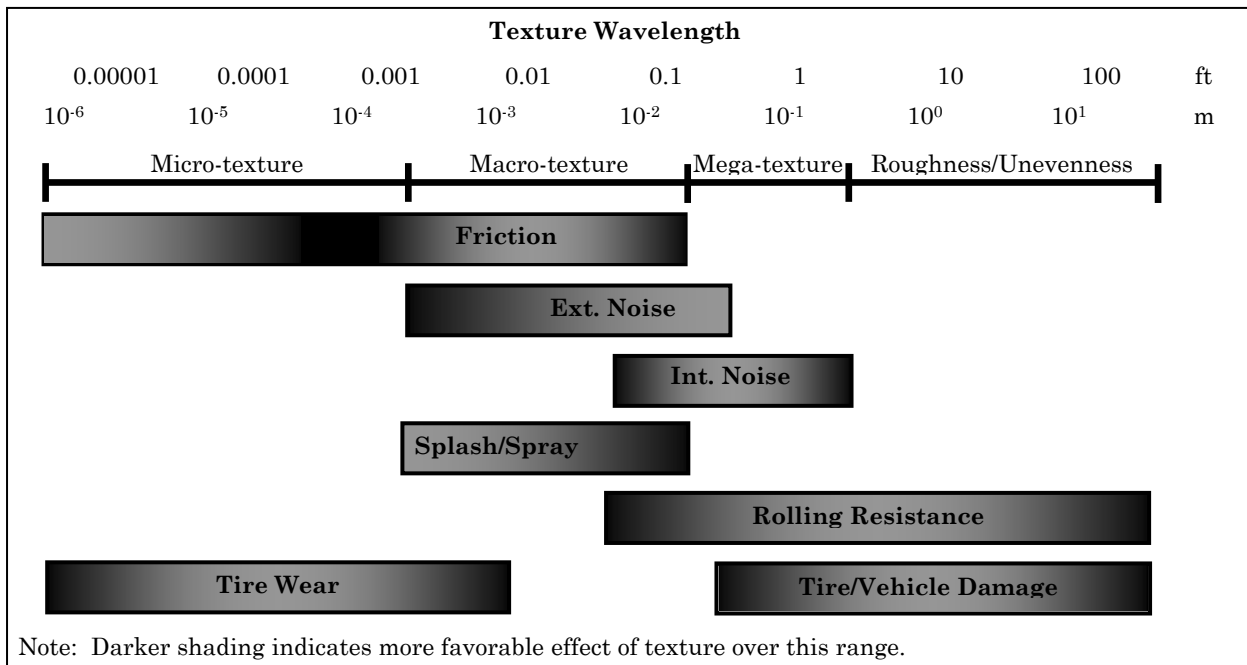

Figure 19. Texture wavelength influence on pavement-tire interactions (adapted from Henry, 2000 and Sandburg and Ejsmont, 2002).

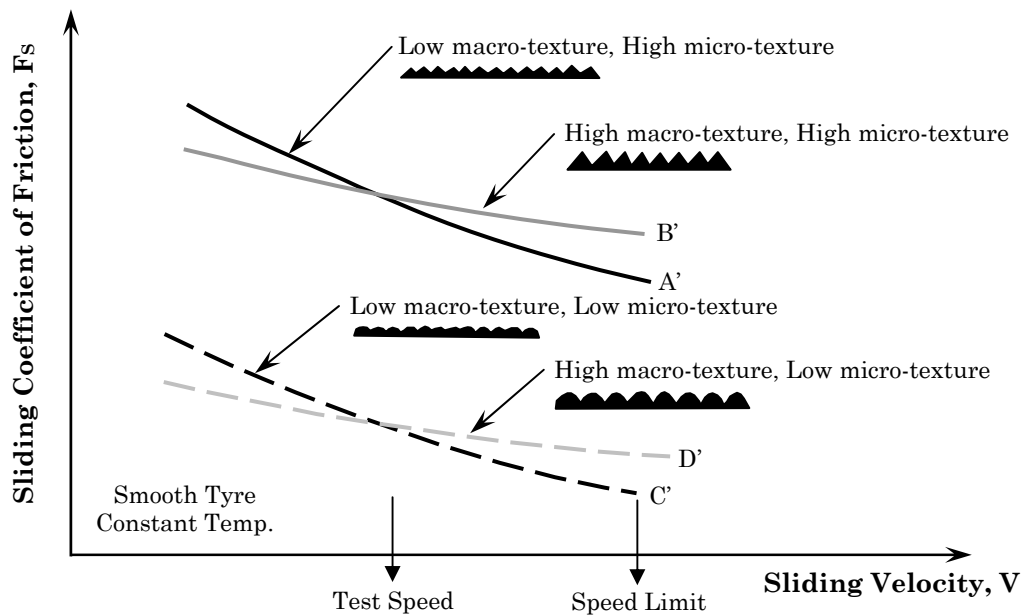

Figure 20. Effect of micro-texture and macro-texture on pavement–tire friction at different sliding speeds (Flintsch et al., 2002).

Factors Affecting Texture

The factors that affect pavement surface texture, which relate to the aggregate, binder, and mix properties of the surface material and any texturing done to the material after placement, are as follows:

- **Maximum Aggregate Dimensions**—The size of the largest aggregates in an asphalt concrete (AC) or exposed aggregate PCC pavement will provide the dominant macro-texture wavelength, if closely and evenly spaced.
- **Coarse Aggregate Type**—The selection of coarse aggregate type will control the stone material, its angularity, its shape factor, and its durability. This is particularly critical for AC and exposed aggregate PCC pavements.
- **Fine Aggregate Type**—The angularity and durability of the selected fine aggregate type will be controlled by the material selected and whether it is crushed.
- **Binder Viscosity and Content**—Binders with low viscosities tend to cause bleeding more easily than the harder grades. Also, excessive amounts of binder (all types) can result in bleeding. Bleeding results in a reduction or total loss of pavement surface micro-texture and macro-texture. Because binder also holds the aggregate particles in position, a binder with good resistance to weathering is very important.
- **Mix Gradation**—Gradation of the mix, particularly for porous pavements, will affect the stability and air voids of the pavement.
- **Mix Air Voids**—Increased air content provides increased water drainage to improve friction and increased air drainage to reduce noise.

- Layer Thickness—Increased layer thickness for porous pavements provides a larger volume for water dispersal. On the other hand, increased thickness reduces the frequency of the peak sound absorption.
- Texture Dimensions—The dimensions of PCC tining, grooving, grinding, and turf dragging affect the macro-texture, and therefore the friction and noise.
- Texture Spacing—Spacing of transverse PCC tining and grooving not only increases the amplitude of certain macro-texture wavelengths, but can affect the noise frequency spectrum.
- Texture Orientation—PCC surface texturing can be oriented transverse, longitudinal, and diagonally to the direction of traffic. The orientation affects tire vibrations and, hence, noise.
- Isotropic or Anisotropic—Consistency in the surface texture in all directions (isotropic) will minimize longer wavelengths, thereby reducing noise.
- Texture Skew—Positive skew results from the majority of peaks in the macro-texture profile, while negative skew results from a majority of valleys in the profile.

Table 3 provides a summary of how these factors influence micro-texture and macro-texture. These factors can be optimized to obtain pavement surface characteristics required for a given design situation.

Table 3. Factors affecting pavement micro-texture and macro-texture (Sandberg, 2002; Henry, 2000; Rado, 1994; PIARC, 1995; AASHTO, 1976).

Pavement Surface Type	Factor	Micro-Texture	Macro-Texture
Asphalt	Maximum aggregate dimensions		X
	Coarse aggregate types	X	X
	Fine aggregate types		X
	Mix gradation		X
	Mix air content		X
	Mix binder		X
Concrete	Coarse aggregate type	X (for exposed agg. PCC)	X (for exposed agg. PCC)
	Fine aggregate type	X	
	Mix gradation		X (for exposed agg. PCC)
	Texture dimensions and spacing		X
	Texture orientation		X
	Texture skew		X

FRICITION AND TEXTURE MEASUREMENT METHODS

Overview

The measurement of pavement friction and texture has been of primary importance for the last 50 years. Many different types of equipment have been developed and used to measure these properties, and their differences (in terms of measurement principles and procedures and the way measurement data are processed and reported) can be significant.

For friction testing alone, there are several commercially produced devices that can operate at fixed or variable slip, at speeds up to 100 mi/hr (161 km/hr), and under variable test tire conditions, such as load, size, tread design and construction, and inflation pressure. Pavement surface texture, whether it be micro-, macro-, or mega-texture, can be measured in a variety of ways, including rubber sliding contact devices, volumetric techniques, and water drainage rate techniques.

This section provides an overview of the friction and texture measurement methods and available representative equipment. ASTM and AASHTO have developed a set of surface characteristic standards and measurement practice standards to ensure comparable texture and friction data reporting. Since the standards ensure comparability of the measurements for practical purposes, the methods and devices are discussed in pairs and are grouped according to measurements performed at highway speeds and measurements requiring lane closure (i.e., low-speed/walking and stationary devices).

In general, the measurement devices requiring lane closure are simpler and relatively inexpensive, whereas the highway-speed devices are more complex, more expensive, and require more training to maintain and operate. With the recent development of technology in data acquisition, sensor technology, and data processing power of computers, the once true superiority of data quality for the stationary and low-speed devices is diminishing. The resolution and accuracy of the data acquired from low-speed or stationary devices can still supersede that of the high-speed devices, but with smaller and smaller margins.

Friction

The two devices commonly used to measure pavement friction characteristics in the laboratory or at low speeds in the field are the British Pendulum Tester (BPT) (AASHTO T 278 or ASTM E 303) and the Dynamic Friction Tester (DFT) (ASTM E 1911). Both these devices measure frictional properties by determining the loss in kinetic energy of a sliding pendulum or rotating disc when in contact with the pavement surface. The loss of kinetic energy is converted to a frictional force and thus pavement friction. These two methods are highly portable and easy to handle. The DFT has the added advantage of being able to measure the speed dependency of the pavement friction by measuring friction at various speeds (Saito et al., 1996).

High-speed friction measurements utilize one or two full-scale test tires to measure pavement friction properties in one of four modes: locked-wheel, side-force, fixed-slip, or variable slip. As noted by Henry (2000) and confirmed by the state survey conducted in this study, the most common method for measuring pavement friction in the U.S. is the locked-wheel method (ASTM E 274). This method is meant to test the frictional properties of the surface under emergency braking conditions for a vehicle without anti-lock brakes. Unlike the side-force and fixed-slip methods, the locked-wheel approach tests at a slip speed equal to the vehicle speed, which means that the wheel is locked and unable to rotate (Henry, 2000).

The results of the locked-wheel test are reported as a friction number (FN , or skid number [SN]), which is computed using the following equation:

$$FN(V) = 100\mu = 100 \times (F/W) \quad \text{Eq. 6}$$

where: V = Velocity of the test tire, mi/hr.
 μ = Coefficient of friction.
 F = Tractive horizontal force applied to the tire, lb.
 W = Vertical load applied to the tire, lb.

Locked-wheel friction testers usually operate at speeds between 40 and 60 mi/hr (64 and 96 km/hr). Testing can be done using a smooth (ASTM E 524) or ribbed tire (ASTM E 501). The ribbed tire is insensitive to the pavement surface water film thickness; thus it is insensitive to the pavement macro-texture. The smooth tire, on the other hand, is sensitive to macro-texture.

The side-force method (ASTM E 670) measures the ability of vehicles to maintain control in curves and involves maintaining a constant angle, the yaw angle, between the tire and the direction of motion. The side-force coefficient (*SFC*) is calculated as follows:

$$SFC(V, \alpha) = 100 \times (F_s/W) \quad \text{Eq. 7}$$

where: V = Velocity of the test tire, mi/hr.
 α = Yaw angle.
 F_s = Force perpendicular to plane of rotation, lb.
 W = Vertical load applied to the tire, lb.

Since the yaw angle is typically small, between 7.5 and 20°, the slip speed is also quite low; this means that side-force testers are particularly sensitive to the pavement micro-texture but are generally insensitive to changes in the pavement macro-texture.

The two most common side-force measuring devices are the Mu-Meter and the Side-Force Coefficient Road Inventory Machine (SCRIM). The primary advantage offered by side-force measuring devices is the ability for continuous friction measurement throughout a test section (Henry, 2000). This ensures that areas of low friction are not skipped due to a sampling procedure.

Fixed-slip devices measure the friction experienced by vehicles with anti-lock brakes. Fixed-slip devices maintain a constant slip, typically between 10 and 20 percent, as a vertical load is applied to the test tire (Henry, 2000). The frictional force in the direction of motion between the tire and pavement is measured, and the percent slip is computed as follows:

$$\text{Percent Slip} = \frac{(V - r \times \omega)}{V} \times 100 \quad \text{Eq. 8}$$

where: *Percent Slip* = Ratio of slip speed to test speed, percent.
 V = Test speed.
 r = Effective tire rolling radius.
 ω = Angular velocity of test tire.

These devices are also more sensitive to micro-texture, as the slip speed is low.

Variable-slip devices (ASTM E 1859) measure the frictional force, as the tire is taken through a predetermined set of slip ratios.

Texture

Texture measuring equipment requiring lane closures include the sand patch method (SPM) (ASTM E 965), the outflow meter (OFM) (ASTM E 2380), and the circular texture meter (CTM) (ASTM E 2157).

The SPM is a volumetric-based spot test method that assesses pavement surface macro-texture through the spreading of a known volume of glass beads in a circle onto a cleaned surface and the measurement of the diameter of the resulting circle. The volume divided by the area of the circle is reported as the mean texture depth (*MTD*).

The OFM is a volumetric test method that measures the water drainage rate through surface texture and interior voids. It indicates the hydroplaning potential of a surface by relating to the escape time of water beneath a moving tire. The equipment consists of a cylinder with a rubber ring on the bottom and an open top. Sensors measure the time required for a known volume of water to pass under the seal or into the pavement. The measurement parameter, outflow time (*OFT*), defines the macro-texture; high *OFT*s indicating smooth macro-texture and low *OFT*s rough macro-texture.

The CTM is a non-contact laser device that measures the surface profile along an 11.25-in (286-mm) diameter circular path of the pavement surface at intervals of 0.034 in (0.868 mm). The texture meter device rotates at 20 ft/min (6 m/min) and generates profile traces of the pavement surface, which are transmitted and stored on a portable computer. Two different macro-texture indices can be computed from these profiles—mean profile depth (*MPD*) and root mean square (*RMS*). The *MPD*, which is a two-dimensional estimate of the three-dimensional *MTD* (Flintsch et al., 2003), represents the average of the highest profile peaks occurring within eight individual segments comprising the circle of measurement. The *RMS* is a statistical value, which offers a measure of how much the actual data (measured profile) deviates from a best-fit (modeled profile) of the data (McGhee and Flintsch, 2003).

High-speed methods for characterizing pavement surface texture are typically based on non-contact surface profiling techniques. An example of a non-contact profiler for use in characterizing pavement surface texture is the Road Surface Analyzer (ROSA_{NV}), developed by the FHWA. ROSA_{NV} is a portable, vehicle-mounted, automated system for the measurement of pavement texture at highway speeds along a linear path. ROSA_{NV} incorporates a laser sensor mounted on the vehicle's front bumper and the device can be operated at speeds of up to 70 mi/hr (113 km/hr). The system calculates both *MPD* and estimated mean texture depth (*EMTD*), which is an estimate of *MTD* derived from *MPD* using a transformation equation.

An automated measurement system provides a large quantity of valuable and less expensive texture data, while greatly reducing the safety and traffic control problems

inherent in the manually performed volumetric methods. Some of the applications of ROSANv include the following:

- Texture measurements for pavement management systems (PMSs).
- Site-specific texture measurements for safety investigations.
- Quality control (QC) measurements for new pavement for certifying pavement meeting contract specifications for texture and aggregate segregation limits.
- Combining friction-testing equipment, such as a skid trailer, with ROSANv for simultaneous surface friction and texture measurement.
- Texture and surface detail measurements (grooving, tining) in noise research studies.

Summary of Test Methods and Equipment

High-speed friction measurement equipment is described and illustrated in tables 4 and 5, and low-speed or stationary friction equipment requiring lane closure is shown in tables 6 and 7. Tables 8 and 9 provide summary information for high-speed texture measurement devices, and tables 10 and 11 provide the same for low-speed texture devices.

Table 4. Overview of highway-speed pavement friction test methods.







Test Method	Associated Standard	Description	Equipment
Locked-Wheel	ASTM E 274	This device is installed on a trailer which is towed behind the measuring vehicle at a typical speed of 40 mi/hr (64 km/hr). Water (0.02 in [0.5 mm] thick) is applied in front of the test tire, the test tire is lowered as necessary, and a braking system is forced to lock the tire. Then the resistive drag force is measured and averaged for 1 to 3 seconds after the test wheel is fully locked. Measurements can be repeated after the wheel reaches a free rolling state again.	Testing requires a tow vehicle and locked-wheel skid trailer, equipped with either a ribbed tire (ASTM E 501) or a smooth tire (ASTM E 524). The smooth tire is more sensitive to pavement macro-texture, and the ribbed tire is more sensitive to micro-texture changes in the pavement. 
Side-Force	ASTM E 670	Side-force friction measuring devices measure the pavement side friction or cornering force perpendicular to the direction of travel of one or two skewed tires. Water is placed on the pavement surface (4 gal/min [1.2 L/min]) and one or two skewed, free rotating wheels are pulled over the surface (typically at 40 mi/hr [64 km/hr]). Side force, tire load, distance, and vehicle speed are recorded. Data is typically collected every 1 to 5 in (25 to 125 mm) and averaged over 3-ft (1-m) intervals.	-The British Mu-Meter, shown at right, measures the side force developed by two yawed (7.5 degrees) wheels. Tires can be smooth or ribbed. - The British Sideway Force Coefficient Routine Investigation Machine (SCRIM), shown at right, has a wheel yaw angle of 20 degrees.  
Fixed-Slip	Various	Fixed-slip devices measure the rotational resistance of smooth tires slipping at a constant slip speed (12 to 20 percent). Water (0.02 in [0.5 mm] thick) is applied in front of a retracting tire mounted on a trailer or vehicle typically traveling 40 mi/hr [64 km/hr]. Test tire rotation is inhibited to a percentage of the vehicle speed by a chain or belt mechanism or a hydraulic braking system. Wheel loads and frictional forces are measured by force transducers or tension and torque measuring devices. Data are typically collected every 1 to 5 in (25 to 125 mm) and averaged over 3-ft (1-m) intervals.	-Roadway and runway friction testers (RFTs). -Airport Surface Friction Tester (ASFT), shown at right. -Saab Friction Tester (SFT), shown at right. -U.K. Griptester, shown at right. -Finland BV-11. -Road Analyzer and Recorder (ROAR). -ASTM E 1551 specifies the test tire suitable for use in fixed-slip devices.  
Variable-Slip	ASTM E 1859	Variable-slip devices measure friction as a function of slip (0 to 100 percent) between the wheel and the highway surface. Water (0.02 in [0.5 mm] thick) is applied to the pavement surface and the wheel is allowed to rotate freely. Gradually the test wheel speed is reduced and the vehicle speed, travel distance, tire rotational speed, wheel load, and frictional force are collected at 0.1-in (2.5-mm) intervals or less. Raw data are recorded for later filtering, smoothing, and reporting.	-French IMAG. -Norwegian Norsemeter RUNAR, shown at right. -ROAR and SALTAR systems. 

Table 5. Additional information on highway-speed pavement friction test methods.

Test Method	Measurement Index	Applications	Advantages	Disadvantages
Locked-Wheel	The measured resistive drag force and the wheel load applied to the pavement are used to compute the coefficient of friction, μ . Friction is reported as friction number (<i>FN</i>) or skid number (<i>SN</i>).	Field testing (straight segments). Network-level friction monitoring.	Well developed and very widely used in the U.S. More than 40 states use locked-wheel devices. Systems are user friendly, relatively simple, and not time consuming.	Can only be used on straight segments (no curves, T-sections, or roundabouts). Can miss slippery spots because measurements are intermittent.
Side-Force	The side force perpendicular to the plane of rotation is measured and averaged to compute the Mu Number, <i>MuN</i> , or the sideways force coefficient, <i>SFC</i> .	Field testing straight sections, curves, steep grades. Data in different applications should be collected separately.	Relatively well controlled skid condition similar to fixed-slip device results. Measurements are continuous throughout a test pavement section. Method is commonly used in Europe.	Very sensitive to road irregularities (potholes, cracks, etc.) which can destroy tires quickly. Mu-Meter is primarily only used for airports in the U.S.
Fixed-Slip	The measured resistive drag force and the wheel load applied to the pavement are used to compute the coefficient of friction, μ . Friction is reported as <i>FN</i> .	Field testing (straight segments). Network-level friction monitoring. Project-level friction monitoring.	Continuous, high resolution friction data collected.	Fixed-slip devices take readings at a specified slip speed. Their slip speeds do not always coincide with the critical slip speed value, especially over ice- and snow-covered surfaces. Uses large amounts of water in continuous mode. Requires skillful data reduction.
Variable-Slip	When used for variable-slip measurements, the system provides a chart of the relationship between slip friction number and slip speed. The resulting indices are: <ul style="list-style-type: none"> • Longitudinal slip friction number • Peak slip friction number • Critical slip ratio • Slip ratio • Slip to skid friction number • Estimated friction number • Rado Shape factor When used for locked-wheel measurements, the system provides <i>FN</i> values.	Field testing (straight or curved segments). Network-level friction monitoring. Project-level friction monitoring.	Can provide continuously any desired fixed or variable slip friction results. Can provide the Rado shape factor for detailed evaluation.	Large, complex equipment with high maintenance costs and complex data processing and analysis needs. Uses large amounts of water in continuous mode.

Table 6. Overview of pavement friction test methods requiring traffic control.



Test Method	Associated Standard	Description	Equipment
Stopping Distance Measurement	ASTM E 445	The pavement surface is sprayed with water until saturated. A vehicle is driven at a constant speed (40 mi/hr [64 km/hr] specified) over the surface. The wheels are locked, and the distance the vehicle travels while reaching a full stop is measured. Alternatively, different speeds and a fully engaged antilock braking system (ABS) have been used.	A passenger car or light truck (at least 3,200 lb [preferable equipped with a heavy-duty suspension system]) is specified. The braking system should be capable of full and sustained lockup. Tires should be ASTM E 501 ribbed design. 
Deceleration Rate Measurement	ASTM E 2101	Testing is typically done in winter contaminated conditions. While traveling at standard speed (20 to 30 mi/hr [32 to 48 km/hr]), the brakes are applied to lock the wheels, until deceleration rates can be measured. The deceleration rate is recorded for friction computation.	Mechanical or electronic equipment, shown at right, is installed on any vehicle to measure and record deceleration rate during stopping. 
Portable Testers	ASTM E 303 ASTM E 1911	<p>Portable testers can be used to measure the frictional properties of pavement surfaces. These testers use pendulum or slider theory to measure friction in a laboratory or in the field.</p> <p>The British Pendulum Tester (BPT) produces a low-speed sliding contact between a standard rubber slider and the pavement surface. The elevation to which the arm swings after contact provides an indicator of the frictional properties. Data from five readings are typically collected and recorded by hand.</p> <p>The Dynamic Friction Tester measures the torque necessary to rotate three small, spring-loaded, rubber pads in a circular path over the pavement surface at speeds from 3 to 55 mi/hr (5 to 89 km/hr). Water is applied at 0.95 gal/min (3.6 L/min) during testing. Rotational speed, rotational torque, and downward load are measured and recorded electronically.</p>	<p>-The BPT is manually operated and documented, as shown at top right.</p> <p>-The DFT, shown at bottom right, is a modular system that is controlled electronically. Results are typically recorded at 12, 24, 36, and 48 mi/hr (20, 40, 60, and 80 km/hr), and the speed, friction relationship can be plotted. It fits in the trunk of a car and is accompanied by a water tank and portable computer.</p>  

Table 7. Additional information on pavement friction test methods requiring traffic control.

Test Method	Measurement Index	Applications	Advantages	Disadvantages
Stopping Distance Measurement	<p>Stopping distance number (<i>SDN</i>) or coefficient of friction (μ) is determined using the following equation:</p> $\mu = \frac{v^2}{2 \times g \times d}$ <p>where: μ = Coefficient of friction. v = Vehicle brake application speed, ft/sec (m/sec). g = Acceleration due to gravity, 32.2 ft/sec² (9.81 m/sec²). d = Stopping distance, ft (m).</p>	<p>Field testing (straight segments).</p> <p>Crash investigations.</p>	<p>Simplest method for determining pavement surface friction.</p>	<p>Test values obtained are not very repeatable. Traffic control is required.</p>
Deceleration Rate Measurement	<p>The measured deceleration force is used to calculate the pavement surface friction coefficient, μ, using the equation:</p> $\mu = \frac{\text{Measured Deceleration}}{g}$ <p>where: μ = Coefficient of friction. g = Acceleration due to gravity, 32.2 ft/sec² (9.81 m/sec²).</p> <p>The measured deceleration can be directly measured for the complete stopping operation or determined for a partial stop as the difference between the initial and final deceleration divided by the braking time.</p>	<p>Field testing (straight segments).</p> <p>Crash investigations.</p>	<p>System is easy to use, small, portable, lightweight, and easy to install and remove.</p>	<p>Requires a sudden braking maneuver to be made, and such maneuvers may not be operationally desirable (Al-Qadi et al., 2002). Cannot be used for network evaluation. Generally requires traffic lane closure.</p>
Portable Testers	<p>The BPT provides a British Pendulum Number (<i>BPN</i>) based on the pendulum swing height of a calibrated BPT.</p> <p>The Dynamic Friction Tester (DFT) produces DFT numbers or friction coefficients and a graph of the friction coefficient for different rotational speeds. This device also reports the peak friction, associated peak slip speed, and the International Friction Index (IFI), designated by <i>F(60)</i> and <i>S_p</i>.</p>	<p>The BPT provides friction and micro-texture indicators for any pavement, whether in the field or from laboratory analysis of cored or prepared samples. It is also used to evaluate the effect of wear on friction and texture.</p> <p>The DFT can be used for field and laboratory testing for quality control/quality assurance (QC/QA), project, and investigatory friction data collection.</p>	<p>The BPT is used worldwide as a measure of friction and texture. It is suitable for both laboratory and field evaluation. The BPT can be used to measure both longitudinal and lateral pavement-tire friction.</p> <p>The DFT provides good repeatability and reproducibility and is unaffected by operators or wind. It also provides friction coefficients that are representative of high speed values. It can produce the IFI statistics, and it correlates well with <i>BPN</i>.</p>	<p><i>BPN</i> variability is large and can be affected by operator procedures and wind effects.</p> <p>Traffic control is required for both portable testers. They do not always simulate pavement-tire characteristics. Both devices collect only spot measurement and cannot be used for network evaluation. To quantify a given section of pavement, several measurements must be made over the length of the section.</p>

Table 8. Overview of highway-speed pavement surface texture test methods.

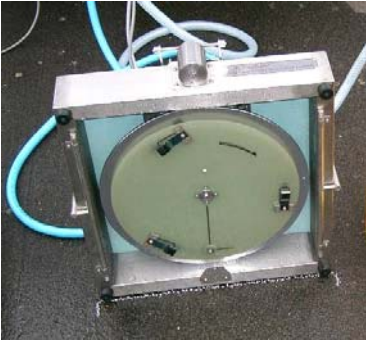

Test Method/ Equipment	Associated Standard	Description	Equipment
Electro-optic (laser) method (EOM)	ASTM E 1845 ISO 13473-1 ISO 13473-2 ISO 13473-3	Non-contact very high-speed lasers are used to collect pavement surface elevations at intervals of 0.01 in (0.25 mm) or less. This type of system, therefore, is capable of measuring pavement surface macro-texture (0.5 to 50 mm) profiles and indices. Global Positioning Systems (GPS) are often added to this system to assist in locating the test site. Data collecting and processing software filters and computes the texture profiles and other texture indices.	High-speed laser texture measuring equipment (such as the FHWA ROSAN system shown at right) uses a combination of a horizontal distance measuring device and a very high speed (64 kHz or higher) laser triangulation sensor. Vertical resolution is usually 0.002 in (0.5 mm) or better. The laser equipment is mounted on a high-speed vehicle, and data is collected and stored in a portable computer. <div style="display: flex; justify-content: space-around;">   </div>

Table 9. Additional information on highway-speed pavement surface texture test methods.

Test Method/Equipment	Measurement Index	Advantages	Disadvantages
Electro-optic (laser) method (EOM)	Using the measured texture profiles, the EOM system computes mean profile depth (<i>MPD</i>) as the difference between the peak and average elevations for consecutive 2-in (50-mm) segments, averaged in 4 in (100 mm) profile segments. Estimated MTD (<i>EMTD</i>) can be computed using a relationship developed between <i>MPD</i> and <i>MTD</i> at the International PIARC Experiment. <i>RMS</i> macro-texture levels can also be computed. The power of texture wavelengths can also be determined using power spectral density computations.	<ul style="list-style-type: none"> • Collects continuous data at high speeds. • Correlates well with MTD. • Can be used to provide a speed constant to accompany friction data. 	<ul style="list-style-type: none"> • Equipment is very expensive. • Skilled operators are required for collection and data processing.

Table 10. Overview of pavement surface texture test methods requiring traffic control.



Test Method/ Equipment	Associated Standard	Description	Equipment	Equipment
Sand Patch Method (SPM)	ASTM E 965, ISO 10844	This volumetric-based spot test method provides the mean depth of pavement surface macro-texture. The operator spreads a known volume of glass beads in a circle onto a cleaned surface and determines the diameter and subsequently mean texture depth (<i>MTD</i>).	Equipment includes: Wind screen, 1.5 in ³ (25,000 mm ³) container, scale, brush, and disk (2.5- to 3-in [60- to 65-mm] diameter). ASTM D 1155 glass beads.	
Outflow Meter (OFM)	ASTM E 2380	This volumetric test method measures the water drainage rate through surface texture and interior voids. It indicates the hydroplaning potential of a surface by relating to the escape time of water beneath a moving tire. Correlations with other texture methods have also been developed.	Equipment is a cylinder with a rubber ring on the bottom and an open top. Sensors measure the time required for a known volume of water to pass under the seal or into the pavement.	
Circular Texture Meter (CTM)	ASTM E 2157	This non-contact laser device measures the surface texture in an 11.25-in (286-mm) diameter circular profile of the pavement surface at intervals of 0.034 in (0.868 mm), matching the measurement path of the DFT. It rotates at 20 ft/min (6 m/min) and provides profile traces and mean profile depth (<i>MPD</i>) for the pavement surface.	Equipment includes a water supply, portable computer, and the texture meter device.	

Table 11. Additional information on pavement surface texture test methods requiring traffic control.

Test Method/Equipment	Measurement Index	Advantages	Disadvantages
Sand Patch Method (SPM)	<p>Mean texture depth (<i>MTD</i>) of macro-texture is computed as:</p> $MTD = \frac{4V}{\pi \times D^2}$ <p>where: <i>MTD</i> = Mean texture depth, in (mm) <i>V</i> = Sample volume, in³ (mm³) <i>D</i> = Average material diameter, in (mm)</p>	<ul style="list-style-type: none"> • Simple and inexpensive methods and equipment. • When combined with other data, can provide friction information. • Widely used method. 	<ul style="list-style-type: none"> • Method is slow and requires lane closure. • Only represents a small area. • Only macro-texture is evaluated. • Sensitive to operator variability. • Labor intensive activity.
Outflow Meter (OFM)	<p>Outflow time (<i>OFT</i>) is the time in milliseconds for outflow of specified volume of water. Shorter outflow times indicate rougher surface texture.</p>	<ul style="list-style-type: none"> • Simple methods and relatively inexpensive equipment. • Provides an indication of hydroplaning potential in wet weather. 	<ul style="list-style-type: none"> • Method is slow and requires lane closure. • Only represents a small area of the pavement surface. • Output does not have a good correlation with MPD or MTD
Circular Texture Meter (CTM)	<p>Indices provided by the CTM include the mean profile depth (<i>MPD</i>) and the root mean square (<i>RMS</i>) macro-texture.</p>	<ul style="list-style-type: none"> • Measures same diameter as DFT, allowing texture–friction comparisons. • Repeatable, reproducible, and independent of operators • Correlates well with <i>MTD</i>. • Measures positive and negative texture. • Is small (29 lb [13 kg]) and portable. • Setup time is short (less than 1 minute) 	<ul style="list-style-type: none"> • Method is slow (about 45 seconds to complete) and requires lane closure. • Represents a small surface area.

FRICTION INDICES

Friction indices have been in use for a long time. In 1965, ASTM started the use of the Skid Number (*SN*) (ASTM E 274) as an alternative to the coefficient of friction. In later years, AASHTO adopted the E 274 test method and changed the terminology from Skid Number to Friction Number (*FN*). In the early 1990s, PIARC developed the International Friction Index (IFI), based on the PIARC international harmonization study. A refined IFI model was developed shortly thereafter as part of a Ph.D. thesis (Rado, 1994).

The use of friction indices has allowed for harmonization of the different sensitivities of the various friction measurement principles to micro-texture and macro-texture. Provided below are brief discussions of these primary friction indices.

Friction Number

The Friction Number (*FN*) (or Skid Number [*SN*]) produced by the ASTM E 274 locked-wheel testing device represents the average coefficient of friction measured across a test interval. It is computed using equation 6, given previously. The reporting values range from 0 to 100, with 0 representing no friction and 100 representing complete friction.

FN values are generally designated by the speed at which the test is conducted and by the type of tire used in the test. For example, $FN_{40R} = 36$ indicates a friction value of 36, as measured at a test speed of 40 mi/hr (64 km/hr) and with a ribbed (*R*) tire. Similarly, $FN_{50S} = 29$ indicates a friction value of 29, as measured at a test speed of 50 mi/hr (81 km/hr) and with a smooth (*S*) tire.

International Friction Index

PIARC sponsored an international friction harmonization study in 1992, in which representatives from 16 countries participated. The experiment was conducted at 54 sites across the U.S. and Europe and included 51 different measurement systems. Various types of friction testing equipment were evaluated, including locked-wheel, fixed-slip, ABS, variable-slip, side-force, pendulum, and some prototype devices. Surface texture was measured by means of the sand patch, laser profilometers (using the triangulation method), an optical system (using the light sectioning method), and outflow meters.

One of the main results of the PIARC experiment was the development of the International Friction Index (IFI). The IFI standardized how the dependency of friction on the tire sliding speed is reported. As a measure of how strongly friction depends on the relative sliding speed of an automotive tire, the gradient of the friction values measured below and above 37 mi/hr (60 km/hr) is reported as the value of an exponential model for the IFI index. This gradient is named the Speed Number (S_P), and is reported in the range 0.6 to 310 mi/hr (1 to 500 km/hr).

The PIARC experiment strongly confirmed that S_P is a measure of the macro-texture influence on surface friction. Macro-texture is recognized as a major contributor to friction safety characteristics for several reasons. The most well known reason is the hydraulic

drainage capability that macro-texture has for wet pavements during or immediately after a rainfall. This capability will also minimize the risk for hydroplaning. Another reason is that the wear or polishing of macro-texture can be interpreted from S_P as it changes value over time for a section of road.

A pronounced peak shape or a steep negative slope of the friction–slip speed curve is considered dangerous. The normal driver will experience an unexpected loss in braking power when the brake pedal is pushed to its maximum, and the braking power is not at its maximum. A smallest possible negative slope or even a flat shape of the friction–slip speed curve is therefore desired and obtained with proper macro-texture.

The IFI is composed of two numbers— $F(60)$ and S_P —and the designation and reporting of this index is $IFI(F(60), S_P)$. The IFI is based on a mathematical model (called the PIARC Friction Model) of the friction coefficient as a function of slip speed and macro-texture. The IFI speed number and friction number are computed using the following equations (expressed in metric form, as outlined in ASTM E 1960):

$$S_P = a + b \times TX \quad \text{Eq. 9}$$

- where: S_P = IFI speed number.
 a, b = Calibration constants dependent on the method used to measure macro-texture.
 For *MPD* (ASTM E 1845), $a = 14.2$ and $b = 89.7$
 For *MTD* (ASTM E 965), $a = -11.6$ and $b = 113.6$.
 TX = Macro-texture (*MPD* or *MTD*) measurement, mm.

$$FR(60) = FR(S) \times e^{\left(\frac{S-60}{S_P}\right)} \quad \text{Eq. 10}$$

- where: $FR(60)$ = Adjusted value of friction measurement $FR(S)$ at a slip speed of S to a slip speed of 60 km/hr.
 $FR(S)$ = Friction value at selected slip speed S .
 S = Selected slip speed, km/hr.

$$F(60) = A + B \times FR(60) + C \times TX \quad \text{Eq. 11}$$

- where: $F(60)$ = IFI friction number obtained from the correlation of equation 11.
 A, B = Calibration constants dependent on friction measuring device.
 C = Calibration constant required for measurements using ribbed tire.

The previous equation can be used to adjust measurements made at speeds other than the standard 40 mi/hr (64 km/hr) with an ASTM E 274 trailer to calculate $FN40$ using the following equation:

$$FN(S) = FN_V \cdot e^{\frac{S-V}{S_p}} \quad \text{Eq. 12}$$

For example, a measurement made at low speed, say 20 mi/hr (32 km/hr), or one made at a high speed of 60 mi/hr (96 km/hr), can be adjusted to $FN40$ by setting S equal to 40 mi/hr (64 km/hr) and V to the measuring speed (20 or 60 mi/hr [32 or 96 km/hr]). Whatever units (mi/hr or km/hr) are used for S and V must also be used for S_P .

The use of IFI to estimate friction values at any speed is illustrated in figure 21. Having measured S_P and the friction value $F(60)$ at 37 mi/hr (60 km/hr), the friction value at any other slip speed can be estimated by choosing a value for S . The friction curve is plotted using the previous equation and the $F(60)$ and S_P number are indicated on the graph.

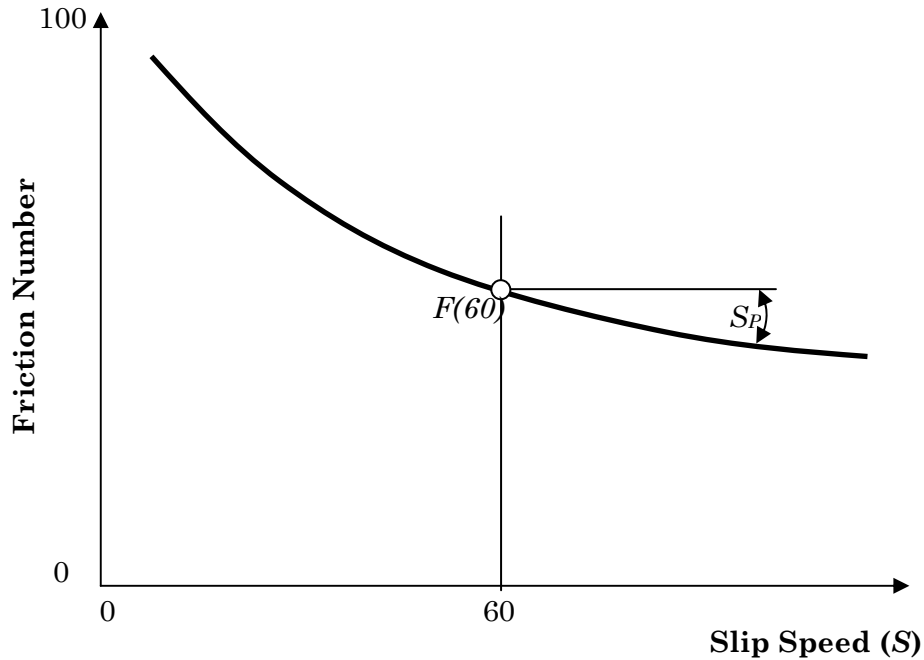

Figure 21. The IFI friction model.

The S_P for the pavement surface may be measured by a device that measures macro-texture. S_P can also be obtained by running a minimum of two measurement runs of the surface with each run at a different slip speed at the same vehicle speed. Some friction measuring devices measure both friction force and macro-texture in the same measurement. The IFI describes the friction experienced by a driver in emergency braking (from wheel lock-up to stop) using non-ABS brakes, whereas the Rado model (discussed next) describes the same braking process using ABS brakes and deals with friction experienced in the initial braking mechanisms.

Rado IFI Model

For estimating braking action with ABS brakes, the maximum friction value, when the wheel is still rolling with low slip ratios, is essential. Under such conditions, the tire will work to give the vehicle directional control, as well as perform braking. In the locked-wheel state, the tire is unable to contribute to directional control.

The Rado friction model was developed to complement the PIARC model by modeling the behavior of the maximum friction value. This model takes the following form:

$$\mu(S) = \mu_{\max} \times e^{-\left(\frac{\ln\left(\frac{S}{S_{\max}}\right)}{\hat{C}}\right)^2} \quad \text{Eq. 13}$$

In this relation, μ_{\max} is the maximum friction value and S_{\max} is the corresponding slip speed, also known as the critical slip speed. In other words, when the tire is slipping on the pavement with S_{\max} slip speed while still rolling, it develops μ_{\max} friction.

\hat{C} is a shape factor that is closely related to the speed constant (S_P) in the PIARC model. The parameter \hat{C} determines the skewed shape of the full friction curve (see figure 22). The Rado model also treats μ_{\max} as a function of surface and tire properties, measuring speed and slip speed.

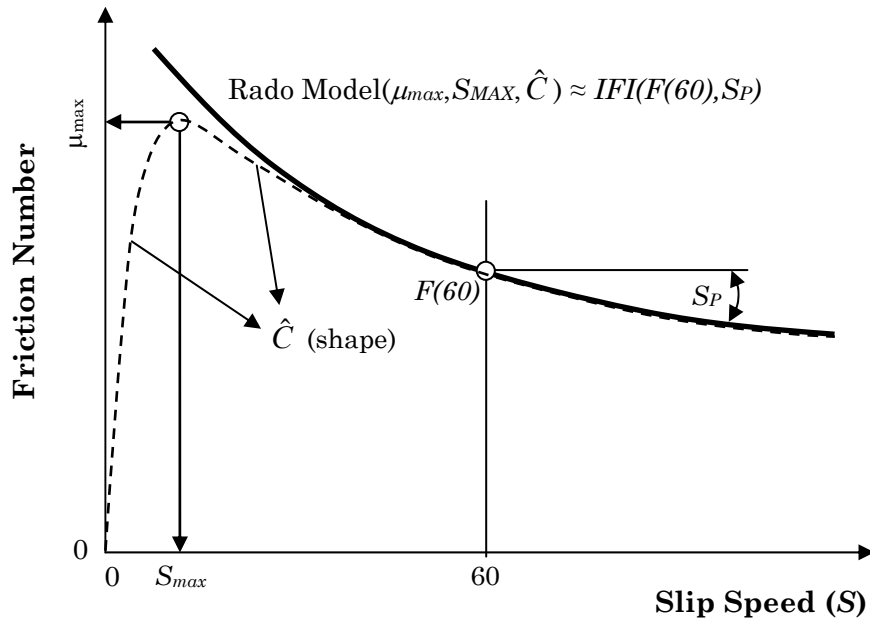

Figure 22. The IFI and Rado IFI friction models (Rado, 1994).

The Rado model lends itself to determining the actual friction curve for a braking process from free rolling to a locked-wheel state. Variable-slip measurement devices can utilize this model to characterize their measurement with three parameters that fully describe the whole friction process (μ_{\max} , S_{\max} , \hat{C}). Utilizing different mathematical procedures, these three parameters can be estimated from raw measured data. This reduces the thousands of measured data points making up the friction curve from a measurement to three numbers that together with the mathematical form can re-create the whole friction curve.

The technique is characterized by doing controlled wheel braking on the measuring tire, while maintaining a constant traveling speed. The measuring wheel is braked gradually from free rolling to locked state through the range of available slip speeds.

By sampling hundreds of friction values at known slip speeds, a friction number curve is fitted to the acquired data points. The equation for the friction number curve is determined. An equation for the maximum friction values is also derived. Using the equations, friction values can be estimated and presented for any slip- and sliding speeds, as well as different traveling speeds under the same environmental conditions.

The Rado model can report the IFI, $F(60)$, and S_P directly. S_P is the derivative of the curve at the $F(60)$ point, when it is transformed to a logarithmic form. Maximum friction values can be predicted for the measured surface stripe at all other traveling speeds for the same tire using this model.

Index Relationships

Over the years, many studies have been performed to correlate the different friction and texture measurement techniques. The established correlations are important in determining how micro-texture and macro-texture affect pavement–tire friction performance over a range of pavement conditions. Discussed below are some of the key relationships.

Micro-Texture

Currently, there is no direct way to measure micro-texture in the field. Even in the laboratory, it has only been done with very special equipment. Because of this and because micro-texture is related to low slip speed friction, a surrogate device is used for micro-texture.

In the past, the most common device was the BPT (ASTM E 303), which produces the low-speed wet friction number BPN . A newer testing device is the DFT (ASTM E 1911), which measures friction as a function of slip speed from 0 to 55 mi/hr (0 to 90 km/hr). The DFT at 20 km/hr ($DFT(20)$) is now being used more and more around the world as a replacement for the BPN . Testing at the NASA Wallops Friction Workshops has shown $DFT(20)$ to be more reproducible than the BPN (Henry, 2000).

Macro-Texture

The primary indexes used to characterize macro-texture are the MTD and the MPD . While it was found in the international PIARC experiment that the best parameter for determining the speed constant (S_P) of the IFI is MPD , good predictive capabilities were also observed for MTD (Henry, 2000). To allow for conversions to either of these macro-texture indexes, the following relationships (given in both English and Metric form, respectively) have been developed (PIARC, 1995):

For estimating *MTD* from profiler-derived measurements of *MPD* (ASTM E 1845):

$$\begin{aligned} \text{Estimated } MTD \text{ (or } EMTD) &= 0.79 \times MPD + 0.009 && \text{English (in)} && \text{Eq. 14} \\ EMTD &= 0.79 \times MPD + 0.23 && \text{Metric (mm)} && \end{aligned}$$

For estimating *MTD* from CTM-derived measurements of *MPD* (ASTM E 2157):

$$\begin{aligned} EMTD &= 0.947 \times MPD + 0.0027 && \text{English (in)} && \text{Eq. 15} \\ EMTD &= 0.947 \times MPD + 0.069 && \text{Metric (mm)} && \end{aligned}$$

For estimating *MTD* from outflow time (*OFT*), as measured with the OFM device (ASTM E 2380) (PIARC, 1995):

$$\begin{aligned} EMTD &= (0.123/OFT) + 0.026 && \text{English (in)} && \text{Eq. 16} \\ EMTD &= (3.114/OFT) + 0.656 && \text{Metric (mm)} && \end{aligned}$$

Friction (Micro-Texture and Macro-Texture)

It has been shown that, using a combination of smooth (ASTM E 524) and ribbed tires (ASTM E 501) at highway speeds (i.e., >40 mi/hr [64 km/hr]), *FN* can be predicted from micro-texture and macro-texture. The relationships (equations 17 through 19) are based on macro-texture measured using the SPM (ASTM E 965) and on *BPN* (ASTM E 303), as a surrogate for micro-texture. Similar equations can be determined from other macro-texture measurement methods (such as *MPD* [ASTM E 1845]) and a surrogate for micro-texture (such as *DFT(20)* [ASTM E 1911]). The *IFI* provides a method to do this through the following equations (Wambold et al., 1984):

$$\begin{aligned} BPN &= 20 + 0.405 \times FN40R + 0.039 \times FN40S && \text{Eq. 17} \\ MTD &= 0.039 - 0.0029 \times FN40R + 0.0035 \times FN40S && \text{Eq. 18} \end{aligned}$$

where: *BPN* = British pendulum number.
FN40R = Friction number using ribbed tire at 40 mi/hr.
FN40S = Friction number using smooth tire at 40 mi/hr.
MTD = Mean texture depth, in.

The set of equations show that *BPN* (micro-texture) is an order of magnitude more dependent on the ribbed tire than on the smooth tire. The reverse is true of *MTD* (macro-texture). Based on a combined set of data (400 measurements) from the NASA Wallops Friction Workshops, the following relationship with an R² value of 0.86 has been developed:

$$FN40R = 1.19 \times FN40S - 13.3 \times MTD + 13.3 \quad \text{Eq. 19}$$

So that a smooth tire friction and texture measurement made to determine *IFI* can still be used to predict *FN40R* for reference. However, the *BPN* is not very reproducible and the equations are only valid for the BPT used in the correlation. For this reason, the following correlations with *DFT(20)* and the *MPD* (from the CTM) were developed using NASA Wallops Friction Workshops data:

$$FNS = 15.5 \times MPD + 42.6 \times DFT(20) - 3.1 \quad \text{Eq. 20}$$

$$FNR = 4.67 \times MPD + 27.1 \times DFT(20) + 32.8 \quad \text{Eq. 21}$$

And, the correlation of $FN40R$, as a function of $FN40S$ and MPD is as follows:

$$FN40R = 0.735 \times FN40S - 1.78 \times MPD + 32.9 \quad \text{Eq. 22}$$

This page intentionally left blank.

CHAPTER 5. PAVEMENT FRICTION MANAGEMENT

INTRODUCTION

Highway safety management in the U.S. essentially began in 1966 with the passage of the Highway Safety Act. This Act created a unique partnership among federal, state and local governments to improve and expand the nation's highway safety activities. The Act established the State and Community Highway Safety Grant Program (U.S.C. Title 23, Section 402), commonly known as the "402" program. State Highway Safety Offices were created as a result of the legislation and were funded mainly with 402 funds.

A typical highway safety management program encompasses all phases of highway life (from roadway design to maintenance), driver attitudes and performance capabilities, environmental conditions, and their influence on the driving task. The aspects of a safety management program of interest to pavement engineers are the design and maintenance of roadways surfaces that enhance highway safety by reducing skid-related crashes (i.e., ensuring there is adequate friction at the pavement–tire interface throughout a pavement service life).

To accomplish this goal, highways agencies in the U.S. and worldwide are increasingly interested in setting up or improving pavement friction management (PFM) programs that help ensure adequate levels of surface friction and texture to minimize the risk of skid-related crashes (FHWA, 1980). To be effective, a PFM program must be an integral part of a comprehensive highway safety management program.

This chapter presents an overview of the typical PFM program. It describes in detail all key components or elements required in setting up and managing a program, and it provides examples of PFM practices and policies.

FEDERAL MANDATES

Since 1966, the U.S. Congress has approved several Acts concerning highway safety. A chronological summary of these Acts and associated directives from federal agencies are summarized in the following sections.

Highway Safety Act of 1966 (23 USC Chapter 4)

The main objective of the Highway Safety Act of 1966 (revised in 1998) was for each state to establish a highway safety program designed to reduce traffic crashes and deaths, injuries, and property damage. The Highway Safety Act specifically mentioned the need for the provision of the following (McNeal, 1995):

- An effective record system of crashes (including injuries and deaths resulting from the crashes).
- Crash investigations to determine the probable causes of crashes, injuries, and deaths.

- Highway design and maintenance (including lighting, markings, and surface treatment).
- Surveillance of traffic for detection and correction of high or potentially high crash locations.

Highway Safety Program Standard 12 (HSPS No. 12) of 1967

As a result of the Highway Safety Act, the FHWA issued Highway Safety Program Standard (HSPS) 12, “Highway Design, Construction, and Maintenance” (McNeal, 1995). The general objectives of this directive were to ensure “that existing streets and highways are maintained in a condition that promotes safety, and that capital improvements either to modernize existing roads or to provide new facilities meet approved safety standards.” It was further required that each state develop special provisions for high skid-resistant qualities in pavement design and construction and for correction of locations with low skid resistance by providing improved surface characteristics (McNeal, 1995).

FHWA Instructional Memorandum 21-2-73

In 1973, the FHWA issued Instructional Memorandum 21-2-73, “Skid-Accident Reduction.” This document changed the federal emphasis from establishing skid-accident reduction programs to evaluating existing programs. The memorandum required every state program to include an evaluation of current pavement design, construction, and maintenance practices to ensure that skid-resistance properties were suitable for the needs of traffic. It also required a systematic procedure to identify and correct hazardous skid-prone locations (McNeal, 1995).

1975 Federal-Aid Highway Program Manual

In 1975, the FHWA issued the *Federal-Aid Highway Program Manual*. A directive, titled “Skid Measurement Guidelines for the Skid-Accident Reduction Program,” suggested that each state’s program consist of the following three basic activities (McNeal, 1995):

- The evaluation of pavement design, construction, and maintenance to ensure that only pavements with good skid resistance characteristics are used in construction and resurfacing.
- The detection of locations with a high incidence of wet-pavement accidents by utilizing the state accident record system and local accident record system, where applicable, and the development of priorities for correction of the locations.
- The analysis of skid resistance for all roads with a speed limit of 40 mi/hr (64 km/hr) or greater, so that skid resistance can be given consideration in development of priorities for resurfacing and maintenance programs.

1980 FHWA *Technical Advisory T 5040.17*

In 1980, the FHWA issued *Technical Advisory T 5040.17*, “Skid Accident Reduction Program.” This advisory was a comprehensive guide for state and local highway agencies in conducting skid-accident reduction programs. The purpose of the Skid Accident Reduction Program was to minimize wet-weather skidding accidents through:

- Identifying and correcting sections of roadway with a high or potentially high incidence of skid-accidents.
- Ensuring that the new surfaces have adequate and durable skid resistance properties.
- Utilizing resources available for accident reduction in a cost effective manner.

A model for the process was developed and proposed, as shown in figure 23.

Intermodal Surface Transportation Efficiency Act (ISTEA) of 1991

The 1991 Intermodal Surface Transportation Efficiency Act (ISTEA) required each state to develop and implement a Safety Management System (SMS) by October 6, 1996.

National Highway System (NHS) Designation Act of 1995

The National Highway System (NHS) Designation Act of 1995 removed the ISTEA mandate for states to implement the management systems. States could elect to adopt the systems in whole or in part.

Transportation Equity Act for the 21st Century of 1998 (TEA-21)

In 1998, the Transportation Equity Act for the 21st Century (TEA-21) was signed into law. TEA-21 basically determined funding levels and formulas to distribute federal transportation trust fund revenues and identified local “high priority” projects. As with past federal transportation Acts, TEA-21 placed considerable emphasis on improving public safety by dedicating over \$2 billion to safety programs. TEA-21 placed more emphasis on incentives to improve safety, rather than federal mandates. Specifically, TEA-21 provided the following:

- State Highway Safety Data Improvement Incentive Grants to encourage states to take effective actions to improve the timeliness, accuracy, completeness, uniformity, and accessibility of their highway safety data.
- Highway Safety Research and Development Program that specifies several new categories of research, including training in work zone safety management; measures that may deter alcohol- or drug-impaired driving; and programs to train law enforcement officers on motor vehicle pursuits.
- Infrastructure Safety: TEA-21 designates “the safety and security of the transportation system for motorized and non-motorized users” as one of the seven newly established areas to be considered in the overall planning process, both at the metropolitan and statewide level.

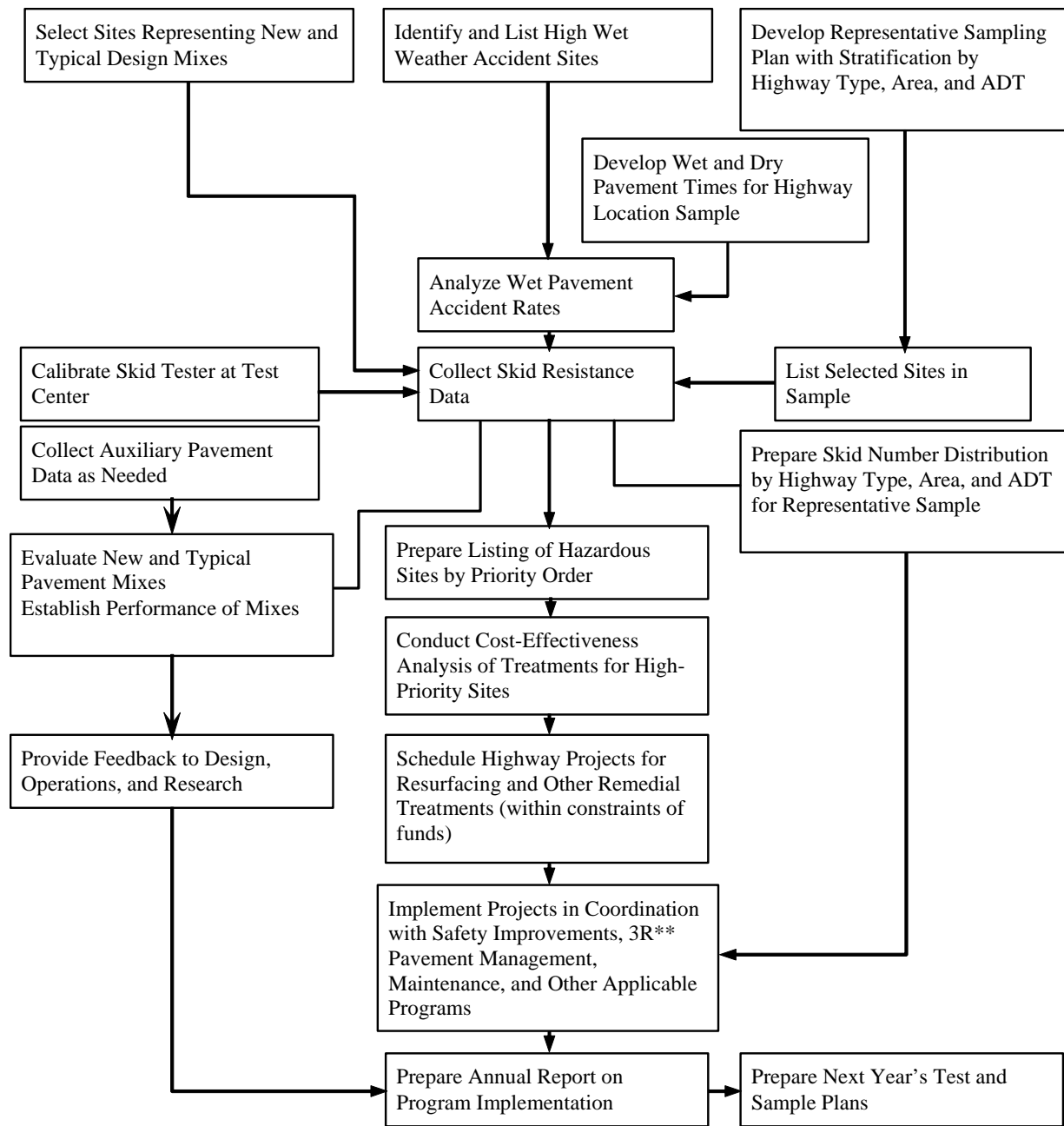

* ADT: Average Daily Traffic

*** 3R: Resurfacing, Restoration, and Rehabilitation

Figure 23. Model skid crash reduction program (FHWA, 1980).

2005 FHWA *Technical Advisory T 5040.36*

In 2005, the FHWA issued *Technical Advisory T 5040.36*, “Surface Texture for Asphalt and Concrete Pavements.” This advisory issued (a) information on state-of-the-practice for providing friction and surface texture on pavements and (b) guidance for selecting techniques that will provide adequate wet pavement friction and low pavement–tire noise characteristics.

The implementation of the various summarized Acts and directives has led to the development of various forms of highway safety management plans and PFM programs. The survey conducted under this study (see appendix C) indicates that most agencies do have some form of PFM. The forms of these programs range from the rudimentary (i.e., periodic friction and texture testing resulting in friction restoration) to the more sophisticated programs that involve routine testing, design and construction guidelines, and research relating friction to skid crashes. The framework of the typical PFM program, along with key elements of the program, is presented in the sections below.

PAVEMENT FRICTION MANAGEMENT FRAMEWORK

Federal mandates and directives generally allow SHAs some flexibility in developing and implementing a PFM program. However, there are three basic elements that are considered vital to any successful PFM program:

- System for evaluating in-service pavements for friction.
 - Collect and analyze friction data of representative pavement sections within a network to develop an understanding of how effective pavement design, construction, and maintenance practices are in providing good friction characteristics.
- System for correlating available friction with wet-weather crashes.
 - Develop an understanding of how pavement friction properties impact crash risk.
- Guidance on the design, construction, and maintenance of pavement surfaces with adequate surface friction throughout the pavement design life.
 - Utilize pavement design, construction, and maintenance practices that result in good friction characteristics to minimize wet weather crashes.

Examples of typical PFM programs are presented in figures 24 through 26. The steps shown in these figures are representative of successful strategies for managing pavement friction. Agencies may vary in the emphasis placed on each of the basic elements of the programs, depending on their current level of understanding of their pavement properties, their access to complete and timely crash data, their ability to collect network friction data, and considerations of the best use of available funds to meet the safety objective.

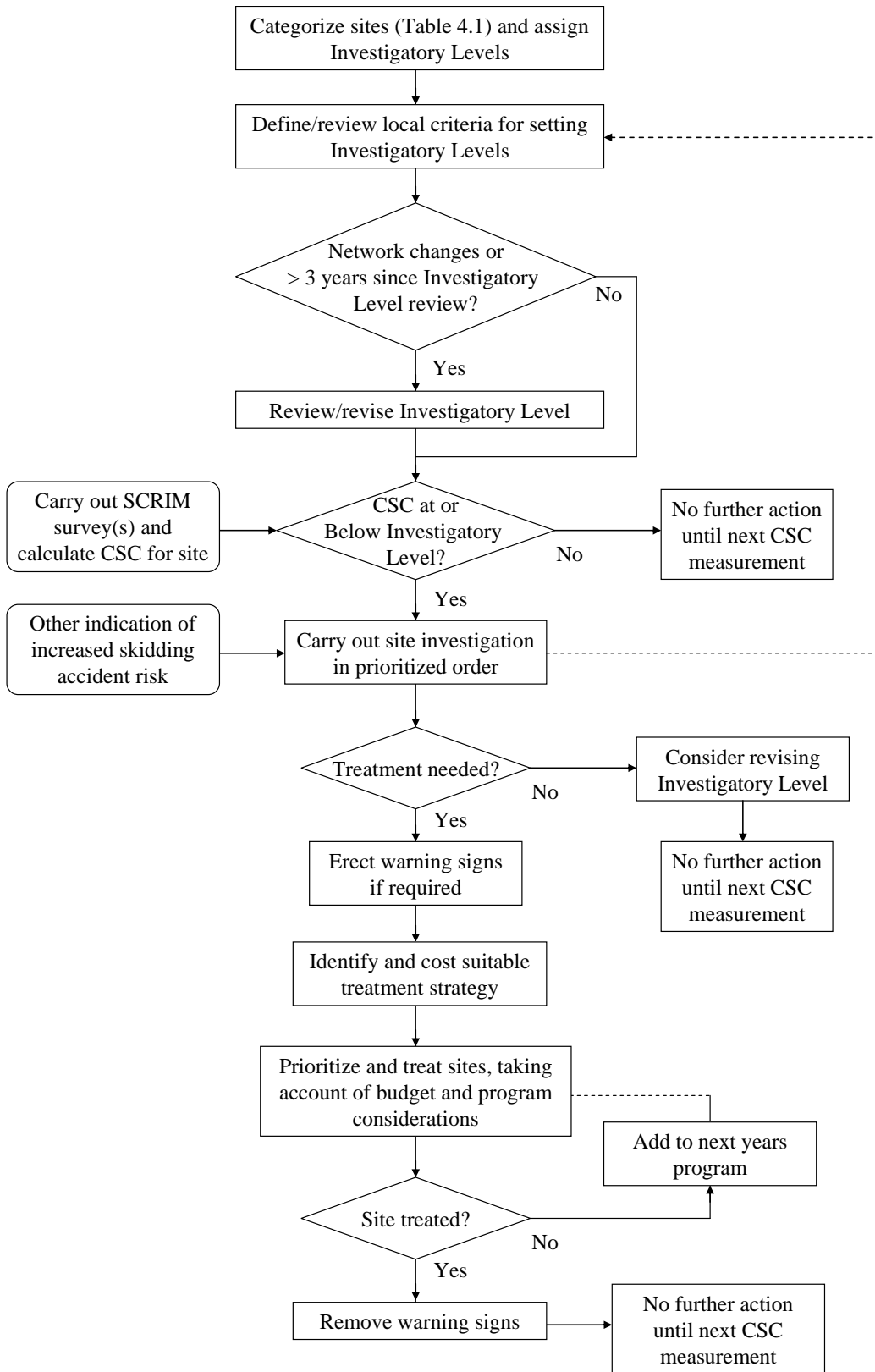

Figure 24. Procedure for identification and prioritization of sites (Highways Agency, 2004).

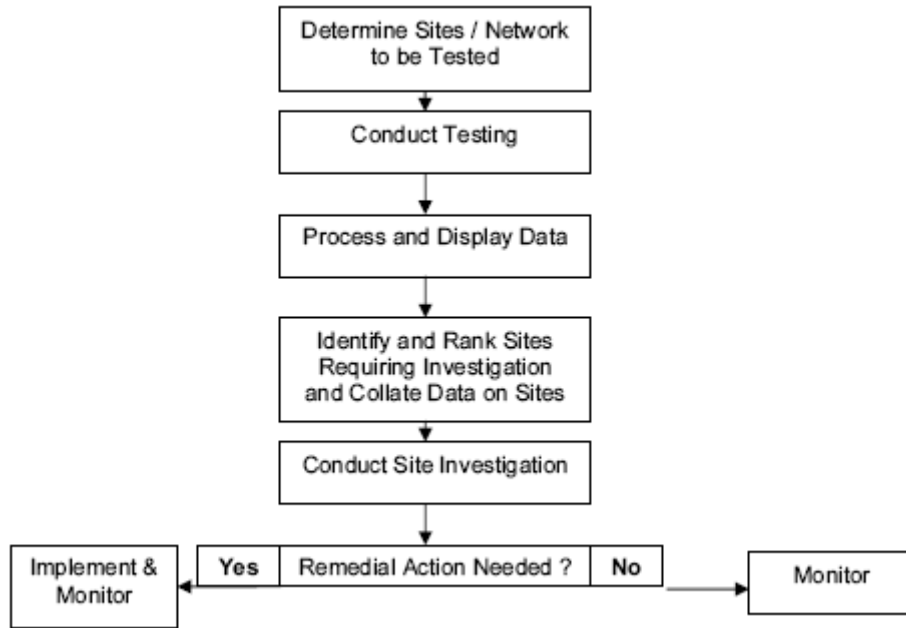

Figure 25. Overview of a proactive strategy to manage friction on road networks (Austroads, 2005).

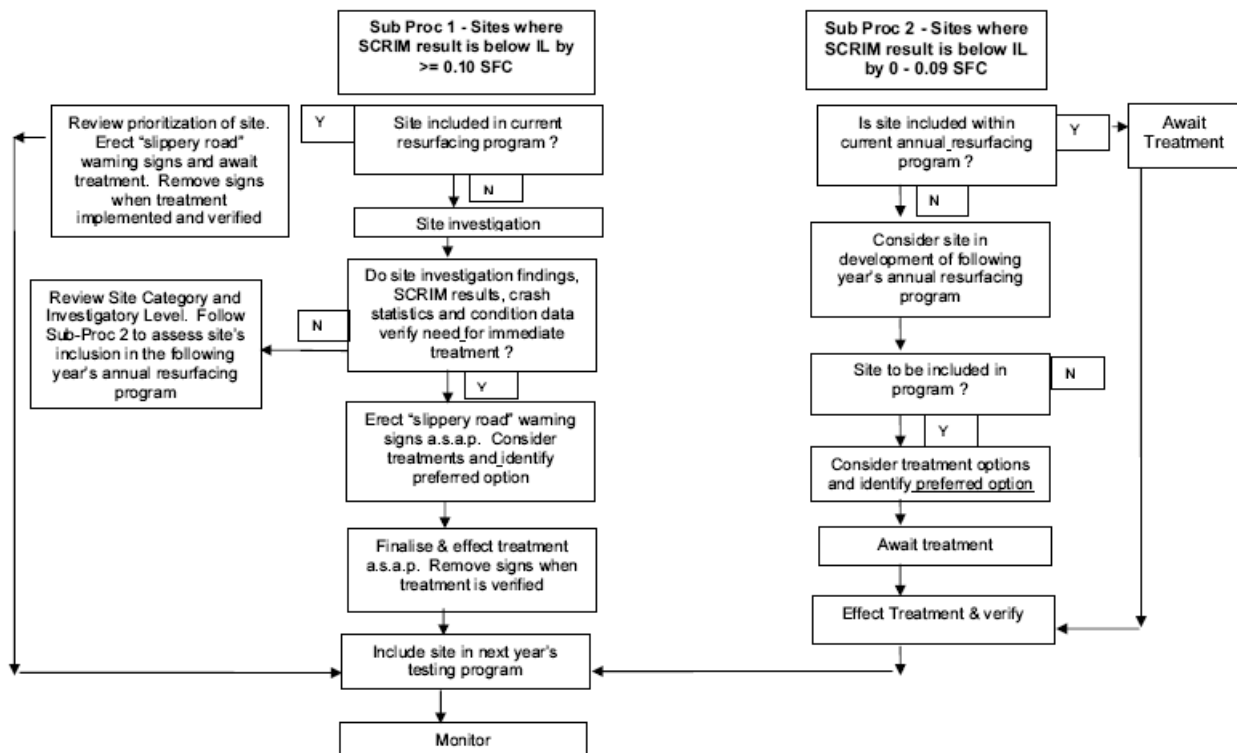

Figure 26. Simplified example of a friction strategy currently operated by a state road authority in Australia utilizing SCRIM (Austroads, 2005).

ESTABLISHING THE PAVEMENT FRICTION MANAGEMENT PROGRAM

Defining Network Pavement Sections

In a traditional PMS, pavement sections within a network are defined for evaluation based on the consistency of structural capacity defined using characteristics such as structural composition (surface type, layer thicknesses, and so on), construction history, and traffic. Sample units within the sections are then identified for the purpose of inspection, field testing, and evaluation.

Defining pavement sections for a PFM program is based on similar principles. The pavement sections must have similar friction demand levels. Therefore, pavement section definition must consider all or any combination of the following factors that influence friction demand:

- Number of crashes, crash rate, or crash severity (or a combination of these).
- Traffic levels (e.g., a criterion based on a set number of vehicles or trucks per lane or per day).
- Highway functional class (e.g., all sites at, or above, a certain functional class in the network will be tested).
- Climatic zones (e.g., all sites with a specified range of annual rainfall or number of wet days per year).
- High risk locations (e.g., curves, intersections, signalized intersections, railway crossings, sites where guardrail is installed on curves).
- Age of surfacing.

For both pavement management and friction management programs, the location of pavement sections are identified using information such as route name or number, direction, county, nearby city or town, milepost limits, and/or station limits. The locations of mostly permanent benchmarks (e.g., bridges, underpasses, and interchanges) closest to the pavement section should also be noted as they provide an important reference point. A PFM program can be easily integrated into an existing PMS if the pavement sections are defined such that they match fairly closely. Overlapping of pavement management and friction management sections makes merging the two difficult. However, the PFM program pavement section can be within a pavement management section. Matching these sections not only makes data storage and retrieval less confusing, but also makes it easier to coordinate field inspection/testing needs for both programs.

Some agencies categorize and prioritize sites based on engineering judgment and/or local concerns and knowledge. However, such criteria should be defined and applied carefully. The criteria ultimately selected are applied to the network to determine the sites that will be subject to testing. The sections can then be programmed with the aim of ensuring geographic efficiency of testing. Allowing other sites (e.g., those identified for research purposes) to be added to the identified sites should be encouraged.

Identifying the level of friction needed by the driving public is the important first step in a PFM program. Although there are no universal criteria for determining the exact level of

friction needed for a project, a rational estimate can be developed by evaluating the array of factors comprising three broad categories—highway alignment, highway features/environment, and highway traffic characteristics. A fourth category, driver/vehicle characteristics, which covers driver skills and age, vehicle tire characteristics, and vehicle steering capabilities, is difficult to assess in terms of friction demand. Discussions of the specific factors comprising the first three categories are provided below.

Highway Alignment

Friction demand is significantly influenced by both the horizontal and vertical alignment of a highway. Descriptions of each and their impacts on demand are summarized below.

Horizontal Alignment

The horizontal alignment of a highway is defined by tangents and curves. The typical curves encountered are simple, compound, and spiral. A horizontal curve is used whenever there is a change in highway direction of sufficient length to avoid the appearance of a kink in the highway horizontal alignment. Small changes in horizontal alignment that will not be noticed by drivers usually do not require horizontal curves.

The amount of friction required increases with increasing complexity of the highway horizontal alignment (i.e., as the alignment changes from a tangent to a horizontal curve). To counter increasing friction demand in horizontal curves, highway designers increase the horizontal radius of curvature and super-elevate the highway cross-section. However, this does not eliminate the need for additional friction.

Figure 27 illustrates the change in highway cross-section as the horizontal alignment transitions from a tangent to a horizontal curve, while figure 28 shows the lateral forces that act on a vehicle as it travels along a curve. As can be seen, the lateral friction developed at the pavement–tire interface is directly related to the square of its speed. As the speed increases, the force required to maintain a circular path eventually exceeds the force that can be developed at the pavement–tire interface and super-elevation. At this point, the vehicle begins to slide in a straight line tangential to the highway alignment, as shown in figure 29 (Farber et al., 1974; Page and Butas, 1986).

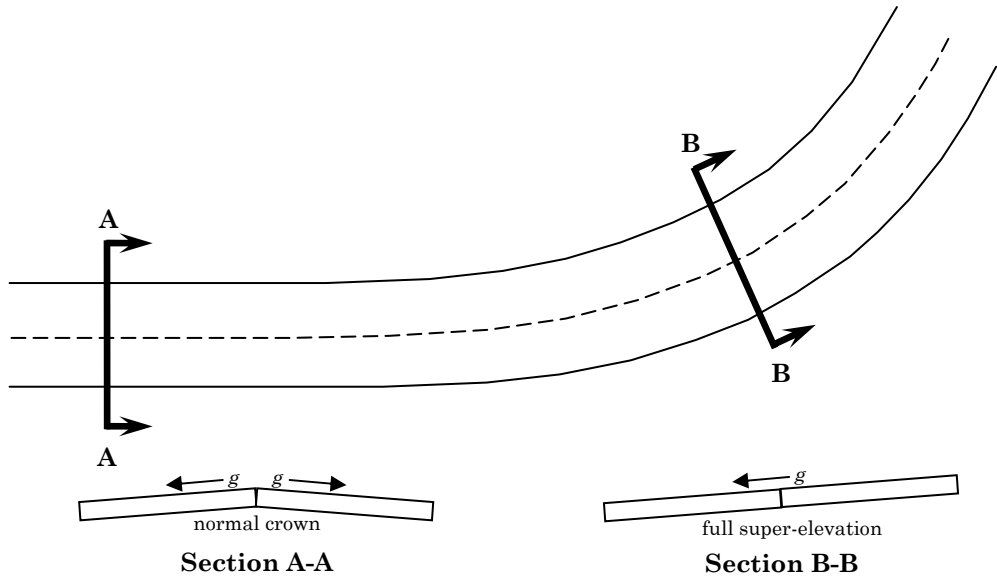

Figure 27. Change in highway cross-section as the horizontal alignment transitions from a tangent to a curve.

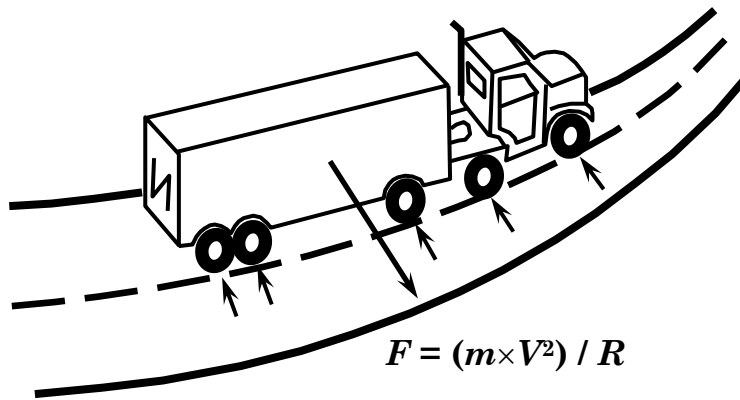

Figure 28. Lateral forces that act on a vehicle as it travels along a curve.

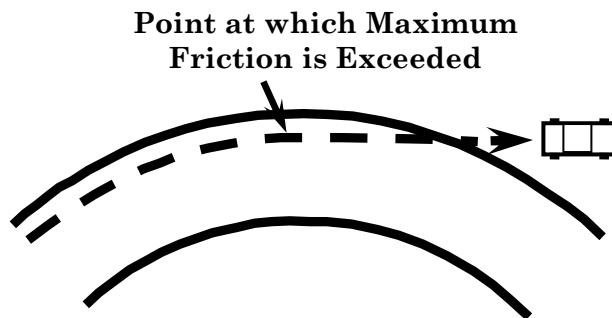

Figure 29. Lateral sliding.

The relationship between side-force friction for horizontal curves (the most critical horizontal alignment), vehicle speed, radius of curvature, and highway cross-section (super-elevation) is defined using the following AASHTO Green Book equation (AASHTO, 2001):

$$F_s = \frac{V^2}{15 \times R} - e \quad \text{Eq. 23}$$

where: F_s = Side-force friction demand.
 e = Super-elevation rate, ft/ft.
 V = Speed, mi/hr.
 R = Radius, ft.

F_s is also a function of climate, tire condition, and driver comfort while performing maneuvers (i.e., braking, making sudden lane changes, and making lateral movements within a lane). Super-elevation is governed by climate (amount of ice and snow), terrain (flat, rolling, mountainous), and frequency of occurrence of slow moving vehicles (that may slip when encountering high super-elevation rates). The maximum super-elevation rate is typically 8 percent, although rates of 10 to 12 percent are common for low-volume roadways in climates with no ice and snow.

The side-force friction computed using this equation is universally accepted as representing the level of friction required for safe driving maneuvers and is recommended in the AASHTO Green Book (2001).

Vertical Alignment

Vertical alignment consists of a series of gradients (grades) connected by vertical curves. It controls how the highway follows existing terrain and its properties are mainly controlled by terrain, horizontal alignment, sight distance, and other factors. The amount of friction required increases with increasing complexity of the vertical alignment (e.g., grade, stopping sight distance).

AASHTO (2001) defines stopping sight distance (SSD) as the distance required for a driver (with a 3.5-ft [1-m] eye height) to clearly see an object 0.5 ft (0.15 m) or more in height on the highway with enough distance to perceive, react, and brake to a stop on a poor wet pavement. It quantifies SSD as the sum of two distances—(a) the distance traveled between the time the driver sees an object and strikes the brakes and (b) the distance traveled after braking commences until the time the vehicle stops. SSD is determined using the equation below:

$$SSD = (1.47 \times V \times t) + \frac{V^2}{30(\mu \pm G)} \quad \text{Eq. 24}$$

where: SSD = Stopping sight distance, ft.
 V = Vehicle speed, mi/hr.
 t = Driver reaction time, sec.
 G = Longitudinal grade, percent.
 μ = Coefficient of friction at the pavement–tire interface.

While the first part of this equation is determined based on driver skill, experience, reaction time, and perception, the second part depends, to some extent, on the highway geometry (longitudinal grade) and available surface friction.

Highway Features/Environment

Highway features/environment is an important but hard-to-measure characteristic of traffic flow that can significantly influence pavement friction. This characteristic of traffic flow is largely defined by the level of interacting traffic situations (e.g., access drives, intersections, entrance/exit ramps), the presence of specially designated lanes (e.g., separate turn lanes at intersections, center left-turn lanes, through versus local traffic lanes), the presence and type of median barriers, and the setting (urban versus rural) of the roadway facility. In general, as the highway environment becomes more difficult and complex, significantly higher levels of friction are required to help drivers perform the necessary maneuvers (e.g., sudden braking).

Table 12 provides an example of how criteria can be established for individual highway features/environment factors for different levels of friction demand. Clearly, for a given factor, the greater the difficulty of driving that is imposed, the higher the demand for pavement friction.

Table 12. Example criteria for highway features/environment factors corresponding to different friction demand levels (modified from TXDOT, 2004).

Facility Type	Highway Features/Environment Factors	Example Criteria for Different Levels of Friction Demand		
		Mild	Moderate	Severe
Controlled Access	Frequency of entrance/exit ramps (number per 1-mi segment)	0 to 2	3 to 4	>4
	Designated lanes	Full-length (interchange to interchange) entrance/exit lanes	Partial-length entrance/exit lanes	None
	Setting	Rural	Rural/Urban	Urban
	Lateral Clearance (adequacy of median and inside and outside shoulders)	Unrestricted	Partially Restricted	Severely Restricted
Uncontrolled Access	Frequency of access drives (number per 1-mi segment)	≤ 10	11 to 30	> 30
	Frequency of signed/signalized intersections (number per 1-mi segment)	0	1 to 3	> 3
	Designated lanes	Separate turn lanes or turning not permitted	Center lane left turn	Turn lanes from through traffic
	Setting	Primarily Residential	Residential/commercial	Commercial
	Median Type	Wide median (> 20 ft)	Narrow median (≤ 20 ft)	No median

1 mi = 1.61 km 1 ft = 0.305 m

Highway Traffic Characteristics

Traffic characteristics that influence friction demand include traffic volume, composition, and speed. Discussions of each are provided below.

Traffic Volume

As traffic volume increases, the number of driving maneuvers taking place along any given segment increases. The risk associated with these increased maneuvers is elevated, especially in high-speed areas. When traffic volume is increased to the point that congestion occurs (ADT > 7,500 veh/day per lane), the possibility of crashes is aggravated if a highway facility is undivided and traffic speed is high (Page and Butas, 1986; Mahone and Runkle, 1972).

Traffic Composition

For the same traffic volume, the composition of traffic vehicles (i.e., the percentage of trucks in the traffic stream) can significantly affect friction demand. There are three primary reasons for this phenomenon. They are:

- Stopping distances of trucks are significantly longer than stopping distances of passenger cars (AASHTO, 2001).
- Trucks have inferior steering capability compared to passenger cars.
- Truck tires produce less friction than passenger car tires.

Hence, for highway segments where a high percentage of trucks is anticipated, friction demand will typically be higher than a corresponding highway having predominantly passenger cars or lower percentage of trucks.

Traffic Speed

Vehicle speed is the most important variable influencing friction demand. For wet pavement surfaces, for instance, an increase in truck speed on tangents from 20 to 70 mi/hr (32 to 113 km/hr) results in an increase in truck stopping distance from 50 to 1,200 ft (15 to 366 m) (Radlinski and Williams, 1985). Such an increase in stopping distance significantly increases the risk of a crash.

Figure 30 shows a conceptual relationship between friction demand and friction availability for wet pavements. As can be seen, an increase in speed results in an increase in friction demand and a decrease in available surface friction (Glennon, 1996).

Speed also contributes to the severity of impact when a collision occurs. For passenger cars colliding with an impact speed of 65 mi/hr (105 km/hr), the likelihood of death is 20 times greater than that associated with an impact speed of 20 mi/hr (30 km/hr) (WHO, 2004). Finally, increasing speed (above 40 mi/hr [64 km/hr]) increases the likelihood of

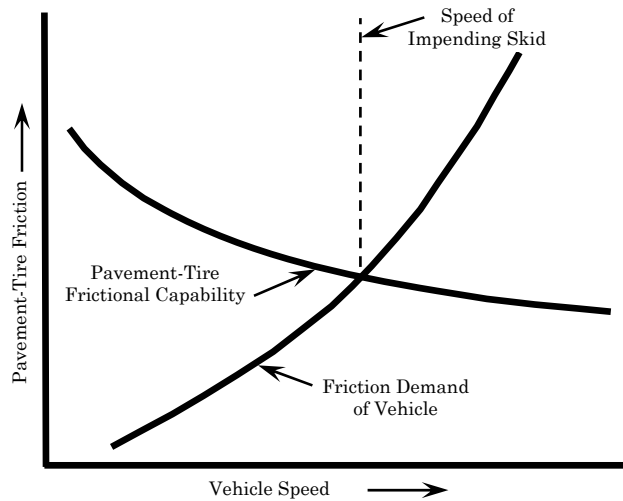

Figure 30. Conceptual relationship between friction demand, speed, and friction availability.

hydroplaning, which is a major cause of wet-weather crashes (Glennon, 1996). The speed of vehicles on the highway must therefore be considered in determining friction demand. Highways with higher posted speed limits and overall travel speeds (85th percentile of vehicle speed) require higher levels of pavement surface friction.

Establishing Friction Demand Categories

Examples of how various agencies categorize friction demand are presented in table 13. Based on the information presented in this table, pavement friction demand categories should be established logically and systematically using the highway alignment, highway features/environment, and highway traffic characteristics factors described above.

Ideally, friction demand categories should be established for individual highway classes, facility types, or access types. Also, the number of demand categories should be kept reasonably small (say, 3 to 5 per highway class, facility type, or access type), so that a sufficient number of PFM sections are available for each category from which to define investigatory and intervention friction levels.

Table 13. Typical friction demand categories.

Site Category	Site Description							
	VicRoads/RTA 1996	New Zealand (Transit New Zealand, 2002)	Main Roads Queensland, Australia	Transport South Australia 2001	United Kingdom (Viner et al., 2004)	Maryland SHA (Chelliah et al., 2003)	Texas DOT (TXDOT, 2004)	
1	<ul style="list-style-type: none"> Traffic light-controlled intersections Pedestrian/school crossings Railway level crossings Roundabout approaches 	<ul style="list-style-type: none"> Approaches to railway level crossings, traffic lights, pedestrian crossings, roundabouts, stop-and-give way controlled intersections (state highway only), one lane bridges (including bridge deck) 	(High) <ul style="list-style-type: none"> Curves with radius ≤ 100 m) Roundabouts Traffic light-controlled intersections Pedestrian/school crossings Roundabout approaches 	<ul style="list-style-type: none"> Difficult sites (steep grades, traffic light approaches, tight bends, roundabouts) 	<ul style="list-style-type: none"> (Q) Approaches to and across minor and major junctions, approaches to roundabouts 	<ul style="list-style-type: none"> Approach railroad crossing, traffic lights, pedestrian crossing, roundabouts, stop-and-give way controlled intersections 	Rainfall, in/yr	>40
							ADT, veh/day	>15,000
							Speed, mi/hr	>60
							Trucks, %	>15
							Vertical grade, %	>5
							Horizontal curve, °	>7
							Driveways, #/mi	>10
							ADT of intersecting roadways, veh/day	>750
							Cross slope, in/ft	>1/4
Design life, years	>7							
2	<ul style="list-style-type: none"> Curves with radius ≤ 250 m Gradients $\geq 5\%$ and ≥ 50 m long Freeway/highway on/off ramps 	<ul style="list-style-type: none"> Curve <250 m radius Down gradient >10% 	(Intermediate) <ul style="list-style-type: none"> Curves with radius ≤ 250 m Gradients $\geq 5\%$ and ≥ 50 m long Freeway and highway on/off ramps Intersections 	<ul style="list-style-type: none"> Urban arterial roads 	<ul style="list-style-type: none"> (K) Approaches to pedestrian crossings and other high risk situations 	<ul style="list-style-type: none"> Curves with radius < 250 m, downhill gradients >10 percent and ≥ 50 m long freeway/highway on/off ramp 	Rainfall, in/yr	>20 and ≤ 40
							ADT, veh/day	>5000 and $\leq 15,000$
							Speed, mi/hr	>35 and ≤ 60
							Trucks, %	>8 and ≤ 15
							Vertical grade, %	>2 and ≤ 5
							Horizontal curve, °	>3 and ≤ 7
							Driveways, #/mi	>5 and ≤ 10
							ADT of intersecting roadways, veh/day	>500 and ≤ 750
							Cross slope, in/ft	1/4 to 3/8
Design life, years	>3 and ≤ 7							

1 ft = 0.305 m 1 in = 25.4 mm 1 mi = 1.61 km

Table 13. Typical friction demand categories (continued).

Site Category	Site Description							
	VicRoads/RTA 1996	New Zealand (Transit New Zealand, 2002)	Main Roads Queensland, Australia	Transport South Australia 2001	United Kingdom (Viner et al., 2004)	Maryland SHA (Chelliah et al., 2003)	Texas DOT (TXDOT, 2004)	
3	• Intersections	<ul style="list-style-type: none"> Approaches to road junctions Down gradient 5-10% Motorway junction area including On/Off Ramps 	(Low) <ul style="list-style-type: none"> Maneuvers—free areas of undivided roads Maneuver—free areas of divided roads 	• Rural arterial roads	• (R) Roundabout	<ul style="list-style-type: none"> Approach to intersections, downhill gradients 5 to 10 percent 	Rainfall, in/yr	≤20
							ADT, veh/day	≤5000
							Speed, mi/hr	≤35
							Trucks, %	≤8
							Vertical grade, %	≤2
							Horizontal curve, °	≤3
							Driveways, #/mi	≤5
							ADT of intersecting roadways, veh/day	≤500
							Cross slope, in/ft	3/8 to 1/2
Design life, years	< 3							
4	• Maneuver-free areas of undivided roads	• Undivided carriageway (event-free)		• Urban lightly trafficked	• (G1) Gradient 5-10% and ≥50 m	• Undivided highways without any other geometrical constraints which influences frictional demand		
5	• Maneuver-free areas of divided roads	• Divided carriageway (event-free)			• (G2) Gradient >10% and ≥ 50 m	• Divided highways without any other geometrical constraints which influences frictional demand		
6	• Curves with radius ≤100 m				• (S1) Bend radius <500 m – dual carriageway			
7	• Roundabouts				• (S2) Bend radius <500 m – single carriageway			

1 ft = 0.305 m 1 in = 25.4 mm 1 mi = 1.61 km

Data Collection

Three key data inputs are required for an effective PFM program: pavement friction, pavement texture, and crash rates. Procedures for collecting these data are presented in this section.

Pavement Friction and Texture

Following are the key issues in setting policy for a routine friction and texture testing program:

- Selection of testing protocol.
- Determination of testing frequency.
- Standardizing testing conditions.
- Test equipment acquisition.
- Equipment calibration and maintenance.

Testing Protocol

At the network level, the locked-wheel friction tester (ASTM E 274) is the most appropriate method of testing. The method is standardized (e.g., test speed, water flow rate), can be performed quickly and at high speeds, and is generally quite repeatable. The method can assess friction and texture by performing tests with both smooth and ribbed tires or with a properly mounted texture laser.

Frequency of Testing

For a network-level evaluation, it is desirable to test all pavement sections annually because of the year-to-year variation in pavement friction. The testing frequency is determined by the length of network to be tested and available resources. A practical approach is a rolling or cyclical testing regime, whereby portions of the network are tested once every few years (e.g., for a rolling 3-year program, one-third of the network is tested each year). A maximum frequency of 4 years is generally desired. Statistical sampling of pavement sections for network level analysis is an acceptable option, as many agencies cannot test 100 percent of their pavement network due to budgetary and/or other constraints.

Testing Conditions

Because pavement friction is influenced by various factors, such as pavement surface temperature, test speed, and ambient weather conditions, testing should be performed under standardized conditions to control the effect of these factors on test results. Controlling testing conditions will minimize variability in test results and produce repeatable measurements. The factors presented in table 14 should be considered along with other relevant factors in establishing testing conditions (Highways Agency, 2004).

Table 14. Summary of key issues to be considered in standardizing test conditions.

Factors	Consideration
Season for testing	<p>Because significant variations in measured friction may occur across seasons within a given year, friction testing should be limited to a specific season or time of year when friction is typically lowest (Highways Agency, 2004). This will help maintain some consistency in year-to-year measurements and reduce variability in measured data. For agencies that cannot perform all testing requirements within a given season, the following can be considered to reduce test variability:</p> <ul style="list-style-type: none"> • Develop correction factors, as needed, to normalize raw friction test data to a common baseline season. • For a given pavement section, initial and subsequent testing must be done within a specific season (e.g., pavement sections originally tested in fall should subsequently be tested in fall).
Test speed	<p>The standard speed recommended by ASTM E-274 for pavement friction tests is 40 mi/hr (64 km/hr). However, since most agencies conduct friction tests without traffic control and because posted or operational speeds vary dramatically throughout a network, it is very difficult for the operator to conduct testing at just this speed. For such situations, the operator typically adjusts test speeds to suit traffic conditions and to assure a safe operation. Thus, it is recommended that friction values corresponding to testing done at speeds other than 40 mi/hr (64 km/hr) be adjusted to the baseline 40-mi/hr (64-km/hr) value to make friction measurements comparable and useful.</p> <p>To do this requires the establishment of correlations between friction measurements taken at 40 mi/hr (64 km/hr) and those taken at other speeds (i.e., speed gradient curves). The following equation can be used to adjust friction measurements to FN_{40}:</p> $FN(S) = FN_V \times e^{-\frac{S-V}{S_P}}$ <p>where: $FN(S)$ = Adjusted value of friction for a speed s. FN_V = Measured friction value at speed V. S_P = Speed number.</p> <p>In order to produce accurate estimates of $FN(S)$, S_P must be established for a broad range of pavement macro-textures and texture measuring devices.</p>
Test lane and line	<p>Friction measurements must be done in the most heavily trafficked lane, as this lane usually carries the heaviest traffic and is, therefore, expected to show the highest rate of friction loss (worst case scenario). For 2-lane highways with a near 50-50 directional distribution of traffic, testing a single lane will suffice; otherwise, the lane in the direction with heavier traffic should be tested. For multi-lane highways, the outermost lane in both directions is typically the most heavily trafficked and should be tested. Where the outermost lane is not the most heavily trafficked, a different lane or more than one lane should be tested.</p> <p>Test measurements must be carried out within the wheelpath, as this is the location where friction loss is greatest. Note that it is important to test along the same lane and wheelpath to maintain some consistency between test results and to reduce variability. If it is necessary to deviate from the test lane and wheelpath (e.g., to avoid a physical obstruction or surface contamination), the test data should be marked accordingly.</p>
Ambient conditions	<p>Because ambient conditions can have an effect on pavement friction, it is important to standardize ambient test conditions to the extent possible and document ambient test conditions so the measurements can be corrected as needed. The following should be noted when setting ambient conditions for testing:</p> <ul style="list-style-type: none"> • Testing in extremely strong side winds must be avoided because these can affect the measurements by creating turbulence under the vehicle that causes the water jet to be diverted from the correct line. • Testing must be avoided in heavy rainfall or where there is standing water on the pavement surface. Excess water on the surface can affect the drag forces at the pavement–tire interface and influence the measurements. • Measurements shall not be undertaken where the air temperature is below 41°F (5°C) (Highways Agency, 2004).
Contamination	<p>Contamination of the pavement surface by mud, oil, grit, or other contaminants must be avoided.</p>

Equipment Calibration and Maintenance

Proper calibration and maintenance of the friction testing equipment is essential to the collection of reliable friction data. To this end, agencies should follow the manufacturer-specified regime or guidance for calibration and maintenance.

Crash Data

Crash data form the basis for analyzing pavement friction and texture data; therefore, an efficient system for collecting and analyzing crash data is critical to a successful PFM program. The quality of the crash data must be as high as possible to be useable in analysis. Crash data are generally available from an agency's crash database or from other sources, such as law enforcement agencies and statistical bureaus.

Although the specific information required for the PFM program depends on the program's objectives, key inputs required to classify and describe crashes include (1) the location (route, milepost, direction) of each crash, (2) vehicles involved along with their characteristics, (3) drivers and passengers involved along with their characteristics, (4) ambient weather conditions at the time of the crash, and (5) injury levels and property damage as a result of the crash.

To get the type of crash information needed to monitor safety throughout a highway network, the crash data must be processed into useable statistics, reportable across defined segments of roadway. Examples of useable statistics are presented in table 15.

Table 15. Examples of useable crash statistics.

Crash Statistics	Project Specific	Control Data for a Given Friction Demand Category		
		Local Agency	Regional/State	National
No. Crashes in X Years of Analysis Period				
Crashes Per 100 mi				
Crashes Per 10 ⁶ veh-mi				
Serious Injury Ratio				
Wet Crash Rate (WCR), percent				
Wet Skidding Rate (WSR), percent				
Skid Crash Rate, percent				

- WSR, which was developed for the national highway network in the UK in the early 1980s, has been found to give a high degree of correlation with changes in skid resistance, and is defined as:

$$\text{WSR (\%)} = (\text{no. of skidding crashes in wet conditions} / \text{no. of crashes in wet conditions}) \times 100.$$
- $\text{WCR (\%)} = (\text{no. of crashes in wet conditions} / \text{total no. of crashes}) \times 100.$
- $\text{Crashes per 100 mi} = (\text{average no. of crashes per year} / \text{site length in mi}) \times 100.$
- $\text{Crashes per } 10^6 \text{ vehicle mi} = \text{average no. of crashes per year} / (\text{site length in mi} \times \text{vehicles per day} \times 365 / 106).$
- $\text{Serious injury ratio} = \text{crashes where a person was killed or seriously injured} / \text{total no. of crashes}.$
- $\text{Skid crash rate (in percent)} = (\text{no. of skidding crashes} / \text{total number of crashes}) \times 100.$

Crash data must be stored in a structured databank, so that each individual crash location can be related to a unique PFM pavement section. The databank must be compatible with an agency's PFM program and must contain sufficient amounts of data for meaningful analysis (i.e., contains crash data for a minimum of 10 years).

It is essential to establish protocols that describe which institutions are responsible for different crash-related data within the highway agency jurisdiction and how the data can be collected. The amount and quality of data vary from institution to institution. For example, the number of crashes reported by the police could be much less than the number reported by hospitals, which could be seen as low compared with the data from insurance companies. Hence, there should be protocols established to cross-check data from all sources and to determine the best sources and the most accurate data to be included in the database. Figure 31 provides an illustration of Iowa's highway safety data integration and analysis system, and shows how crash-related data collected from various agencies are integrated, analyzed, and used in safety management.

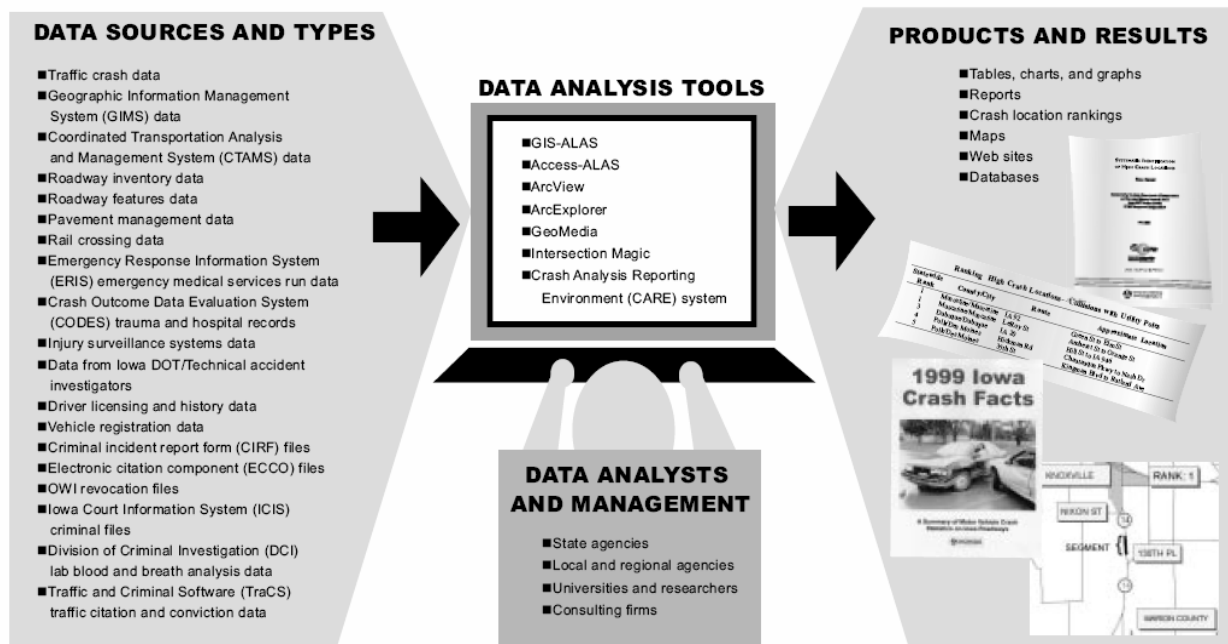

Figure 31. Illustration of Iowa's highway safety data integration and analysis system (Iowa DOT, 2005).

Data Analysis

Establishing Investigatory and Intervention Friction Threshold Levels

Because conditions and circumstances along a highway change, there is no one friction level that defines the threshold between “safe” and “potentially unsafe.” Although the ideal situation is to have friction supply meet or exceed friction demand over the entire system, such a practice would be prohibitively expensive (as well as largely unnecessary) and would not generate the cost-benefits associated with a better-targeted strategy.

A more practical approach, therefore, is to maintain an appropriate level of pavement friction for all pavement sections within the highway network, based on each section’s friction demand. This approach ensures the provision of adequate friction levels for a variety of roadway (intersections, approaches to traffic signals, tight curves) and traffic conditions.

In a PFM program, the adequacy of friction is assessed using the two distinct threshold levels defined earlier in this chapter—investigatory and intervention. Pavement sections with measured friction values at or below an assigned investigatory level are subject to a detailed site investigation to determine the need for warning or remedial action, such as erecting warning signs, performing more frequent testing and analysis of friction data and crash data, or applying a short-term restoration treatment. For pavement sections with friction values at or below the intervention level, remedial action may consist of either immediately applying a restoration treatment or programming a treatment into the maintenance or construction work plan and erecting temporary warning signs at the site of interest.

The establishment of investigatory and intervention levels requires detailed analyses of micro-texture and macro-texture data, and crash data, if available. Such analyses must be carried out separately for each friction demand category established by the agency.

Presented in the sections below are three feasible methods for setting investigatory or intervention friction levels, either in terms of FN or in terms of $IFI(F(60), S_P)$. These methods are derived from many years of discussions at national and international meetings and workshops on pavement friction (e.g., ASTM E 17, TRB AFD90, PIARC TC 1 [now T4.2], and the NASA Wallops Friction Workshops). It is recommended that one of these methods be used in identifying deficient or potentially deficient PFM sections.

Establishing Thresholds Using Historical Pavement Friction Data Only (Method 1)

This method uses historical trends of friction loss determined by plotting friction loss against pavement age or time for a specific friction demand category. The investigatory level is set at the pavement friction value where friction loss begins to increase at a significantly faster rate. The intervention level is then set at a certain amount (e.g., five $F(60), S_P$ or five FN points) or percentage (e.g., 10 percent) below the investigatory level.

The friction value at which friction loss begins to increase rapidly can be determined graphically or through the use of analytical/statistical methods. An example graphical based method includes the following steps:

- Step 1—Plot pavement friction versus age/time for a given friction demand category (figure 32).
- Step 2—Develop a friction loss deterioration curve based on the measured data.
- Step 3—Graphically determine the slopes of the three stages of the S-shaped friction loss versus pavement age/time relationship.
- Step 4—Set the investigatory level as the friction value where there is a significant increase in the pavement friction loss.
- Step 5—Set intervention level at a certain value or percentage below the investigatory level.

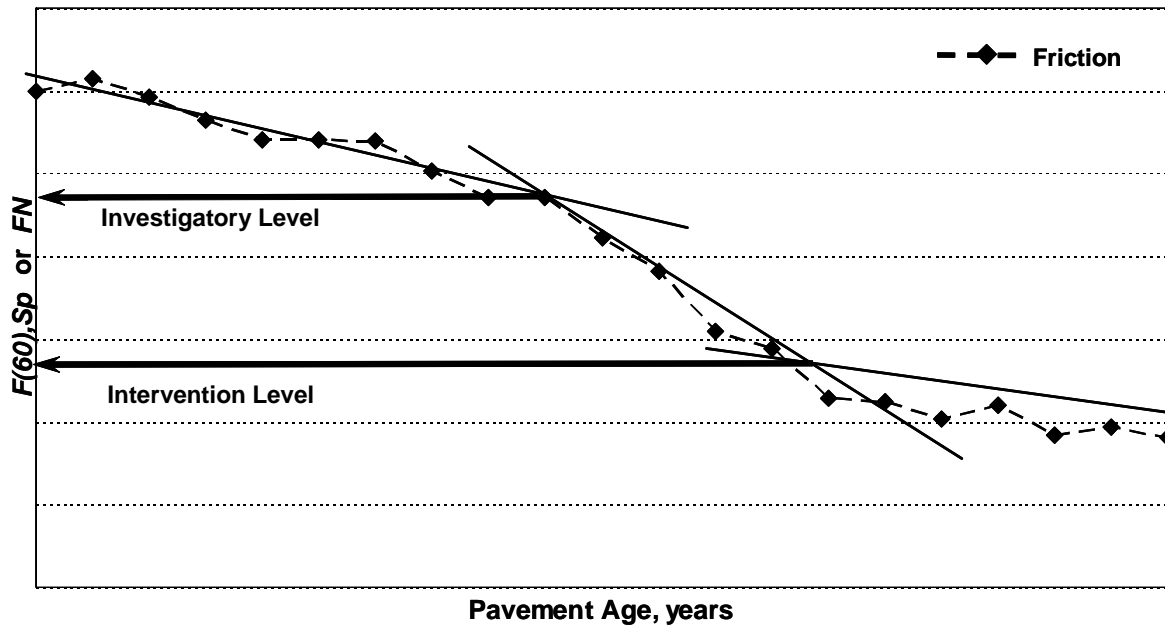

Figure 32. Setting of investigatory and intervention levels for a specific friction demand category using time history of pavement friction.

Establishing Thresholds Using Both Historical Pavement Friction Data and Crash Data (Method 2)

This method compares historical pavement friction and crash data for the given friction demand category for which levels are being set. Figure 33 shows a plot of friction and wet-to-dry crash trends for a specific friction demand category. The investigatory level is set corresponding to a large change in friction loss rate while the intervention level is set where there is a significant increase in crashes.

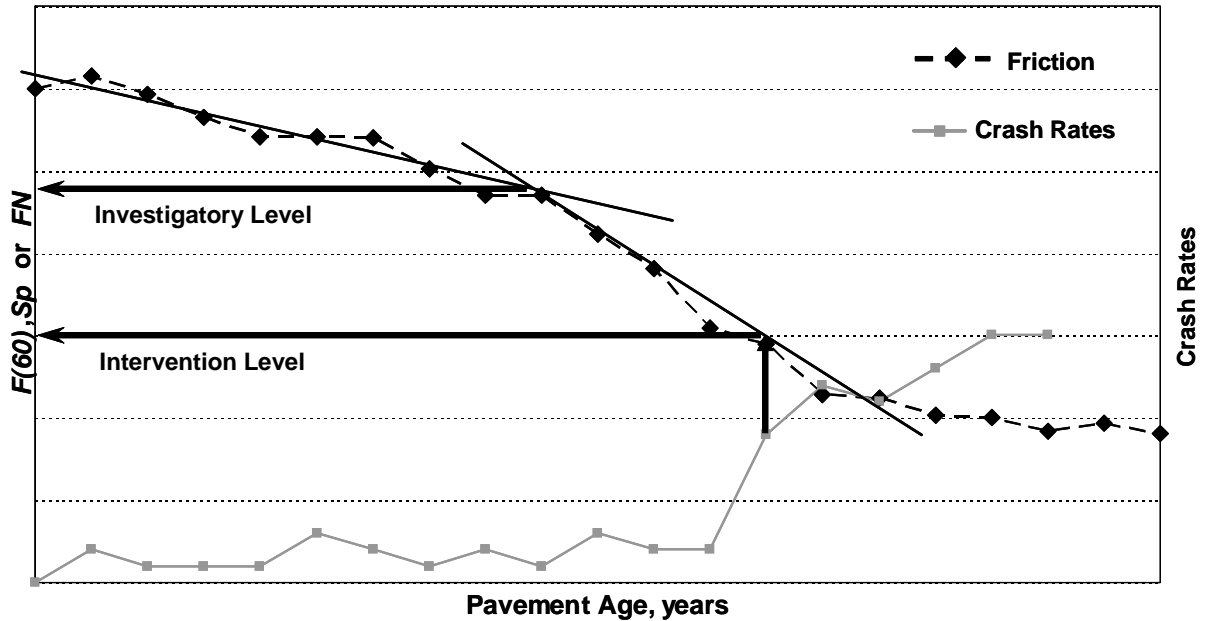

Figure 33. Setting of investigatory and intervention levels for a specific friction demand category using time history of friction and crash rate history.

Establishing Thresholds Using Pavement Friction Distribution and Crash Rate–Friction Trend (Method 3)

This method uses the distribution of friction data versus the crash rates that correspond with the friction for the category of roadway for which the levels are being set. An example of using this method includes the following steps:

- Step 1—Plot a histogram of pavement friction for a given friction demand category, based on current history. On the same graph, plot the current wet-to-dry crash ratio for the same sections as the friction frequency distribution (figure 34).
- Step 2—Determine the mean pavement friction and standard deviation for the pavement friction frequency distribution.
- Step 3—Set the investigatory level as the mean friction value minus “X” standard deviations (say, 1.5 or 2.0) of the distribution of sections and adjust to where wet-to-dry crashes begin to increase considerably.
- Step 4—Set intervention level as the mean friction value minus “Y” standard deviations (say, 2.5 or 3.0) of the distribution of sections and adjust the level to a minimum satisfactory wet-to-dry crash rate or by the point where the amount of money is available to repair that many roadway sections.

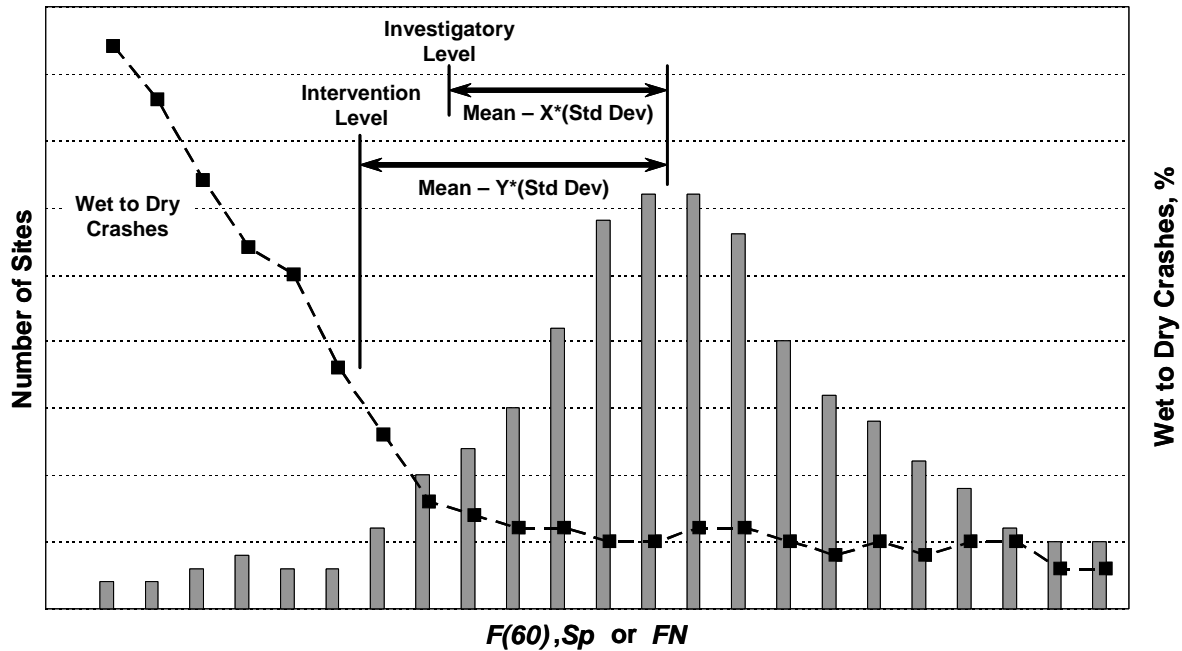

Figure 34. Setting of investigatory and intervention levels for a specific friction demand category using pavement friction distribution and crash rate–friction trend.

Method 3 is the most robust approach. It has the advantage of allowing one to discern the number of roadway sections below a certain level and to make adjustments to the level to accommodate a highway agency's needs and budget.

As in any engineering decision, one must weigh the financial implications of maintaining highway safety through managing pavement friction levels. Thus, an agency should examine the effects of using different investigatory and intervention levels in terms of the improvement in safety and the cost to achieve the level. The levels can then be adjusted to optimize the increase in safety to the agency's budget.

Regardless of the method used, the investigatory and intervention levels selected should be reviewed periodically and revised as needed. Improvements in highway safety standards may require changes in the levels set by an agency. Examples of recommended investigatory friction levels developed by selected agencies are presented in tables 16 through 19.

Table 16. Levels of pavement friction required for various friction demand categories (VicRoads/RTA, 1996).

Site Category	Site Description	Investigatory Level (<i>SFC50</i>)	
		Primary Roads and Secondary Roads >2,500 vehicles per lane per day	Secondary Roads <2,500 vehicles per lane per day
1	Traffic light controlled intersections Pedestrian/school crossings Railway level crossings Roundabout approaches	0.55	0.50
2	Curves with radius ≤ 250 m Gradients $\geq 5\%$ and ≥ 50 m long Freeway/highway on/off ramps	0.50	0.45
3	Intersections	0.45	0.40
4	Maneuver-free areas of undivided roads	0.40	0.35
5	Maneuver-free areas of divided roads	0.35	0.30
Investigatory Level (<i>SFC20</i>)			
6	Curves with radius ≤ 100 m	0.60	0.55
7	Roundabouts	0.55	0.50

1 ft = 0.305 m

Table 17. Levels of pavement friction required for various friction demand categories (Transit New Zealand, 2002).

Category	Site Definition	Investigatory Level (SFC)
1	Approaches to railway level crossings, traffic lights, pedestrian crossings, roundabouts, stop and give way controlled intersections (state highway only), one lane bridges (including bridge deck).	0.55
2	Curve <250 m radius. Down gradient >10%	0.50
3	Approaches to road junctions. Down gradient 5 to 10%. Motorway junction area including on/off Ramps.	0.45
4	Undivided carriageway (event-free).	0.40
5	Divided carriageway (event-free).	0.35

1 ft = 0.305 m

Table 18. Friction demand categories used by Maryland SHA (Chelliah et al., 2003).

Site Category	Site Description	Design FN Required	Demand Category
1	Approach railroad crossing, traffic lights, pedestrian crossing, roundabouts, stop-and-give way controlled intersections.	55	High
2	Curves with radius <250 m, downhill gradients >10 percent, and ≥50 m long freeway/highway on/off ramp.	50	High
3	Approach to intersections, downhill gradients 5 to 10 percent	45	High
4	Undivided highways without any other geometrical constraints which influences frictional demand.	40	Low
5	Divided highways without any other geometrical constraints which influences frictional demand.	35	Low

Note: The Maryland SHA procedures for determining friction demand are based on a procedure originally developed by VicRoads in Australia. The VicRoads procedure was modified and calibrated for U.S. traffic conditions and aggregate testing methods. Friction demand is categorized for this procedure based on how much shear stress the pavement surfacing attracts from vehicles performing evasive traffic actions. The nature and complexity of the evasive actions is directly related to the level of pavement surface friction that would be required to ensure its success.

Sites without any geometrical constraints are categorized as low frictional demand sites, while sites with geometrical constraints, such as railroad crossings, traffic lights, pedestrian crossings, roundabouts, stop and yield controlled intersections, curves, and freeway entrance/exit ramps are categorized as high frictional demand sites.

Maryland also uses the following model to determine friction demand:

$$FN_{DESIGN} = \left(\frac{V^2}{2 \times D \times G \times 24.525} \right) \times 5280$$

where: FN_{DESIGN} = Required friction at anticipated maximum speed.

D = Stopping distance, ft.

V = Anticipated speed, mi/hr.

G = Gravitational acceleration, ft/sec².

Table 19. U.K. site categories and investigatory levels (Viner et al., 2004).

Site Category	Definition	Investigatory Level at 50 km/hr							
		0.30	0.35	0.40	0.45	0.50	0.55	0.60	0.65
A	Motorway								
B	Dual carriageway non-event								
C	Single carriageway non-event								
Q	Approaches to and across minor and major junctions, approaches to roundabouts								
K	Approaches to pedestrian crossings and other high-risk situations								
R	Roundabout								
G1	Gradient 5 to 10% longer than 50 m								
G2	Gradient >10% longer than 50 m								
S1	Bend radius <500 m – dual carriageway								
S2	Bend radius <500 m – single carriageway								

1 ft = 0.305 m

Notes:

1. Investigatory levels are for the mean skidding resistance within the appropriate averaging length.
2. Investigatory levels for site categories A, B, and C are based on 100 m averaging lengths (50 m lengths for some Overseeing Organizations) or the length of the feature if it is shorter.
3. Investigatory levels and averaging lengths for site categories Q, K, G and S are based on the 50 m approach to the feature but this shall be extended when justified by local site characteristics.
4. Investigatory levels for site category R are based on 10 m lengths.
5. Residual lengths less than 50% of a complete averaging length may be attached to the penultimate full averaging length, providing the site category is the same.
6. As part of site investigation, individual values within each averaging length should be examined and the significance of any values which are substantially lower than the mean value assessed.

Identification of Pavement Sections Requiring Detailed Site Investigation or Intervention

Once a section has been identified as being at or below a friction threshold level, steps must be taken to identify the cause(s) of the deficiency. If *FN* is being used, then the agency must caution highway users by installing appropriate signs (e.g., slippery when wet, reduced speed) and then proceed with plans for a detailed investigation of the section.

If the *IFI* is being used, a quick assessment can be made of the friction and texture measurements to determine if micro-texture or macro-texture, or both, are inadequate and in need of improvement. A graph similar to figure 35 can be developed and used, not only as an aid to the detailed investigation, but to select the type of warning that should be posted.

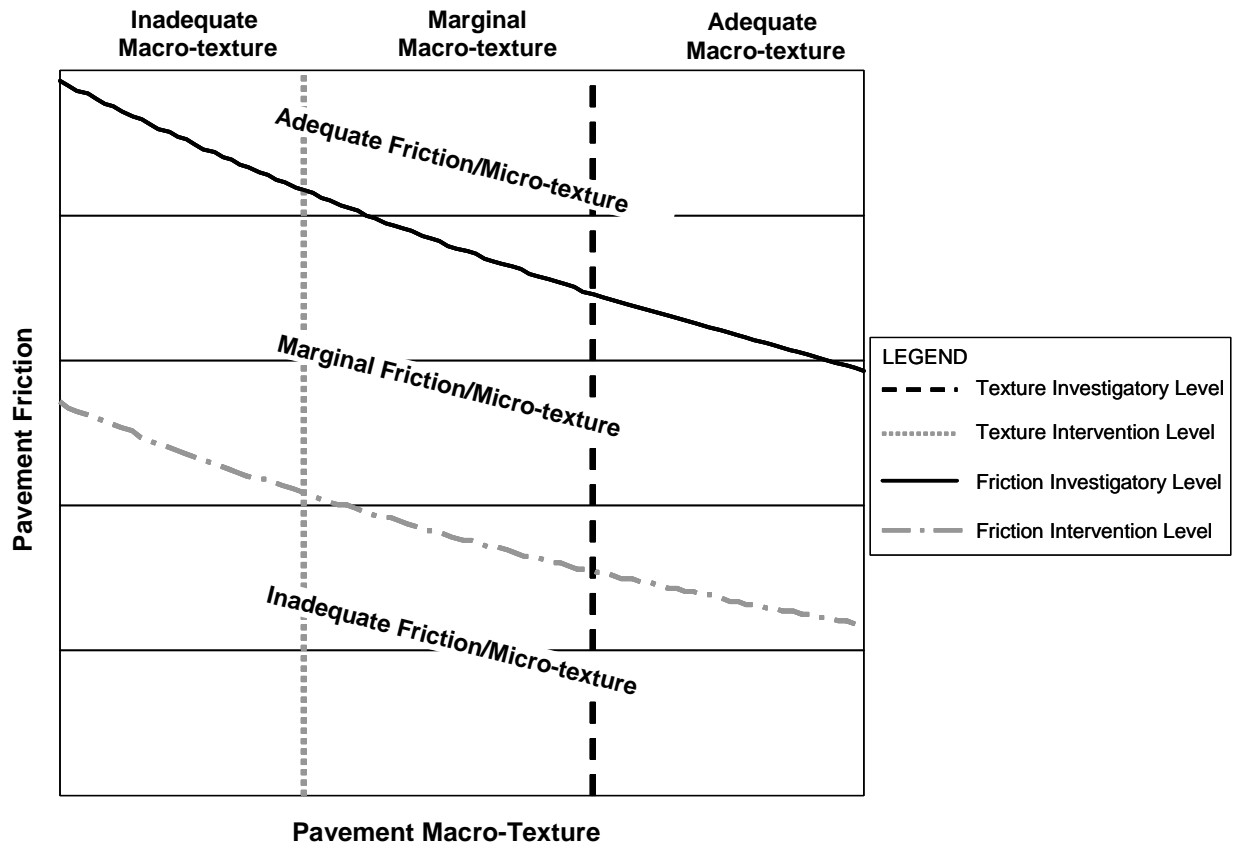

Figure 35. Determination of friction and/or texture deficiencies using the IFI.

Detailed Site Investigation

A detailed site investigation of all pavement sections at or below the investigatory or intervention level is necessary to (a) identify all other factors besides friction that are adversely impacting safety and (b) determine the specific causes of inadequate micro-texture and/or macro-texture. The detailed investigation involves two steps, as described below.

Step 1—Conduct Visual/Video Survey

Each deficient section should first be evaluated for features or characteristics of the roadway that may be compounding the friction problem, both in terms of available friction and friction demand. Such items include the horizontal and vertical alignment, the layout of lanes, intersections, and traffic control devices, the presence, amount, and severity of pavement distresses (e.g., potholes, rutting, bleeding, deteriorated patches), longitudinal pavement smoothness, and transverse pavement profile. Also of importance in the detailed investigation are the issues of glare (as caused by the pavement or the lack of appropriate traffic aids), splash and spray, and hydroplaning potential (often linked to rutting or inadequate cross-slope). Detailed discussions of these latter two items are provided below.

Splash and Spray

While there is currently very little data/information on the relationship between highway crashes and splash and spray, it is obvious that these occurrences can reduce a driver's vision and increase the risk of crashes. Splash and spray from passing and/or leading vehicles make seeing ahead, behind, and to the sides more difficult, particularly at night.

The fog-like phenomenon associated with spray typically results in greater loss of visibility as compared to splash, due to the propensity of small water droplets to remain airborne longer than large droplets. This "fog" can linger as long as it is being replenished by the interaction of the three elements that produce it—standing water; a hard, smooth, non-porous, surface; and turbulent air flow that picks up and carries the water (NHTSA, 1998).

The occurrence of splash/spray is influenced by the drainage condition at the pavement surface. Providing positive drainage that quickly removes standing water from the pavement surface will reduce the occurrence of splash/spray significantly. Pavement surface drainage is enhanced by providing adequate amounts of macro-texture and cross-slope.

Hydroplaning Potential

As discussed earlier, hydroplaning refers to the separation of the tire contact from the pavement surface by a layer of water. It is a complex phenomenon that is affected by (1) the water film thickness (*WFT*) on the pavement surface, (2) pavement macro-texture, (3) tire tread depth, (4) tire inflation pressure, (5) tire contact area, and (6) vehicle speed.

For a vehicle to experience hydroplaning, two things must occur simultaneously: there must be a sufficient buildup of water on the pavement surface and the vehicle must be traveling at a speed high enough to cause hydroplaning. Thus, the potential for hydroplaning for a given highway segment can be assessed by determining (1) the frequency of water buildup from precipitation (rainfall only) on the pavement surface and (2) whether the traveling speeds of vehicles is high enough to result in hydroplaning for the water buildup conditions.

A three-step procedure for determining hydroplaning potential is presented below.

- Step 1—Estimate Critical Hydroplaning Speed (*HPS*): An approximate relationship between the vehicle speed (in mi/hr) at which hydroplaning for both asphalt and concrete pavements will occur and the tire inflation pressure (in lb/in²) is as follows (Ong and Fwa, 2006):

$$HPS = 10.35 \sqrt{\text{tire pressure}} \quad \text{Eq. 25}$$

This equation assumes that *WFT* on the pavement surface exceeds the combined capability of the surface macro-texture and tire design (i.e., tread depth) to remove water from the pavement surface.

- Step 2—Compute *WFT* using agency-established models or procedures or the *WFT* prediction models (and accompanying software) developed in NCHRP Project 1-29 (Anderson et al., 1998).
- Step 3—Determine Hydroplaning Potential: As shown in table 20, hydroplaning potential is categorized as none, low, moderate, or high.

Table 20. Assessment of hydroplaning potential based on vehicle speed and water film thickness.

Average Vehicle Speed (85 th Percentile of Traveling Speed) minus Critical Hydroplaning Speed (<i>HPS</i>), mi/hr ^a	<i>WFT</i> , in		
	< 0.02	0.02 to 0.06	> 0.06
Less than -5	None	None	None
Between ±5	None	Low	Moderate
Greater than 5	None	Moderate	High

1 mi/hr = 1.61 km/hr

1 in = 25.4 mm

^a Guidelines for determining design speed based on highway functional classification, location (i.e., rural versus urban), and terrain type (i.e., level, rolling, and mountainous) can be found in the AASHTO Green Book (AASHTO, 2001).

Step 2—Evaluate Micro-Texture and Macro-Texture

The second step in the detailed site investigation involves testing the pavement surface for micro-texture and macro-texture. These two properties can be evaluated using various types of equipment, including:

- Micro-texture, which can be evaluated using any of the following:
 - Locked-wheel friction tester.
 - British Pendulum Tester (BPT).
 - Dynamic Friction Tester (DFT).
- Macro-texture, which can be evaluated using any of the following:
 - High-speed laser.
 - Circular Texture Meter (CTM).
 - Sand Patch Method (SPM).

Testing must be done in a manner that produces results that are representative of the entire pavement section.

In addition to the micro-texture and macro-texture data, the following information must be obtained from the records or through field testing:

- Traffic applications, including truck percentages.
- Pavement surface age.
- Surface material type and/or finishing method.
- Data on all materials used in the surface pavement (e.g., fine/coarse aggregate type), including polishing/wear characteristics, structure, hardness, and so on, if available.
- Other information, such as data from laboratory tests.

Using the micro-texture and macro-texture results and the data listed above, the exact cause of friction loss can be determined. Common causes of friction loss include polishing of coarse aggregates and excessive wearing of the pavement surface resulting in a loss of macro-texture. Table 21 lists the many specific actions recommended when conducting a detailed site investigation.

Table 21. Recommended actions for detailed site investigations
(Chelliah et al., 2003; TXDOT, 2004; Austroads, 2005; Viner et al., 2004).

Step	Description	Recommended Action
1	Site location	<ol style="list-style-type: none"> 1. What is the friction demand for this location? 2. What are the current investigatory and intervention levels? 3. Has there been any substantial change in the amount or type of traffic applied or highway features to warrant a change in friction demand category and associated changes in investigatory and intervention levels? If so, reclassify the friction demand as appropriate. 4. Document recent weather and traffic conditions at the site location. Has there been any unusually bad weather (excessive rainfall, snow, blizzards, etc.)? Document unusual weather occurrences and investigate if they can be a possible reason for spikes in crash rates.
2	Pavement condition	<ol style="list-style-type: none"> 1. What is the current friction levels? 2. By how much is the current friction level below the investigatory level and over what length? 3. Is pavement friction uniform along the site or are there significant variations? If there are significant variations, perform a detailed visual assessment and testing as needed to describe this situation in detail. 4. Is the minimum pavement friction measurement below the intervention level? If so what percentage of the site is below the intervention level?
3	Crash history	<ol style="list-style-type: none"> 1. What is the location of crashes in relation to the observed variability in measured pavement friction? 2. Are crashes generally located in localized areas with low friction? 3. If not, is there any other pattern apparent in the location or type of crashes that would warrant more crash investigation? 4. Have there been any significant changes to the site or the traffic using it in the analysis period, which could have affected the number of crashes?
4	Visual assessment	<ol style="list-style-type: none"> 1. Is a visual inspection of surface condition consistent with the available survey data? 2. Friction is generally measured in the nearside wheel track in the outside lane. Is the rest of the area of the maintained pavement surface visually consistent with the measured path, or are there any localized areas of polished surfacing, low texture depth, patching or areas otherwise likely to give rise to uneven friction (i.e., is it likely that the friction of other lanes could be lower than the lane tested)? 3. If there is a lack of uniformity in friction measurements across the site, is it likely to increase the risk of crashes occurring?

Selection and Prioritization of Restoration Treatments

The final step in a PFM program is to analyze the collected data to identify sites requiring more frequent monitoring or forensic investigation, and sites requiring friction restoration. Highway agencies normally use pavement friction and other condition data to identify and prioritize sites to be included in a program for:

- Short-term remedial (maintenance) works.
- Comprehensive restoration treatment (e.g., diamond grinding, cold milling, thin overlays, chip seals) aimed directly at improving friction.

In analyzing pavement friction data, the minimum desirable outcome is to ensure that the most “deficient” sites are detected and given reasonable priority, because they are likely to have more impact on highway user safety. The extent of the analysis and use of pavement friction and other data is determined locally by the agency. However, in its simplest possible form, analysis can be restricted to identifying all sites where the measured pavement friction is at or below any investigatory or intervention level that has been set. This is followed up by a detailed site investigation to identify required actions that include:

1. Continue to monitor the site: Such a decision typically would be reached where (a) current crash rates are sufficiently low and an increase is not expected to significantly impact safety and (b) the pavement surface does not require maintenance because of other factors.
2. Listing the site for remedial action to improve pavement friction (e.g., resurface, retexture): This usually would apply where an increase in crash rate might occur if friction remains the same or continues to decrease, and such an increase would significantly impact safety.

Deficient sites requiring restoration are prioritized so that sites urgently requiring attention are dealt with first. In practice, a cut-off is likely to be reached when the available funding is exhausted, after which it is common for the remaining sites in the list to be considered together with other sites requiring short-term remedial works.

Pavement Friction Management Approach and Framework

To develop PFM policies, an agency must identify an overall approach for managing pavement friction and a process for implementing it. The comprehensive PFM program shown in figure 36 may be used. It is comprised of the following key components:

- Network Definition—Subdivide the highway network into distinct pavement sections and group the sections according to levels of friction need.
 - Define pavement sections.
 - Establish friction demand categories.
- Network-Level Data Collection—Gather all the necessary information.
 - Establish field testing protocols (methods, equipment, frequency, conditions, etc.) for measuring pavement friction and texture.
 - Collect friction and texture data and determine overall friction of each section.
 - Collect crash data.

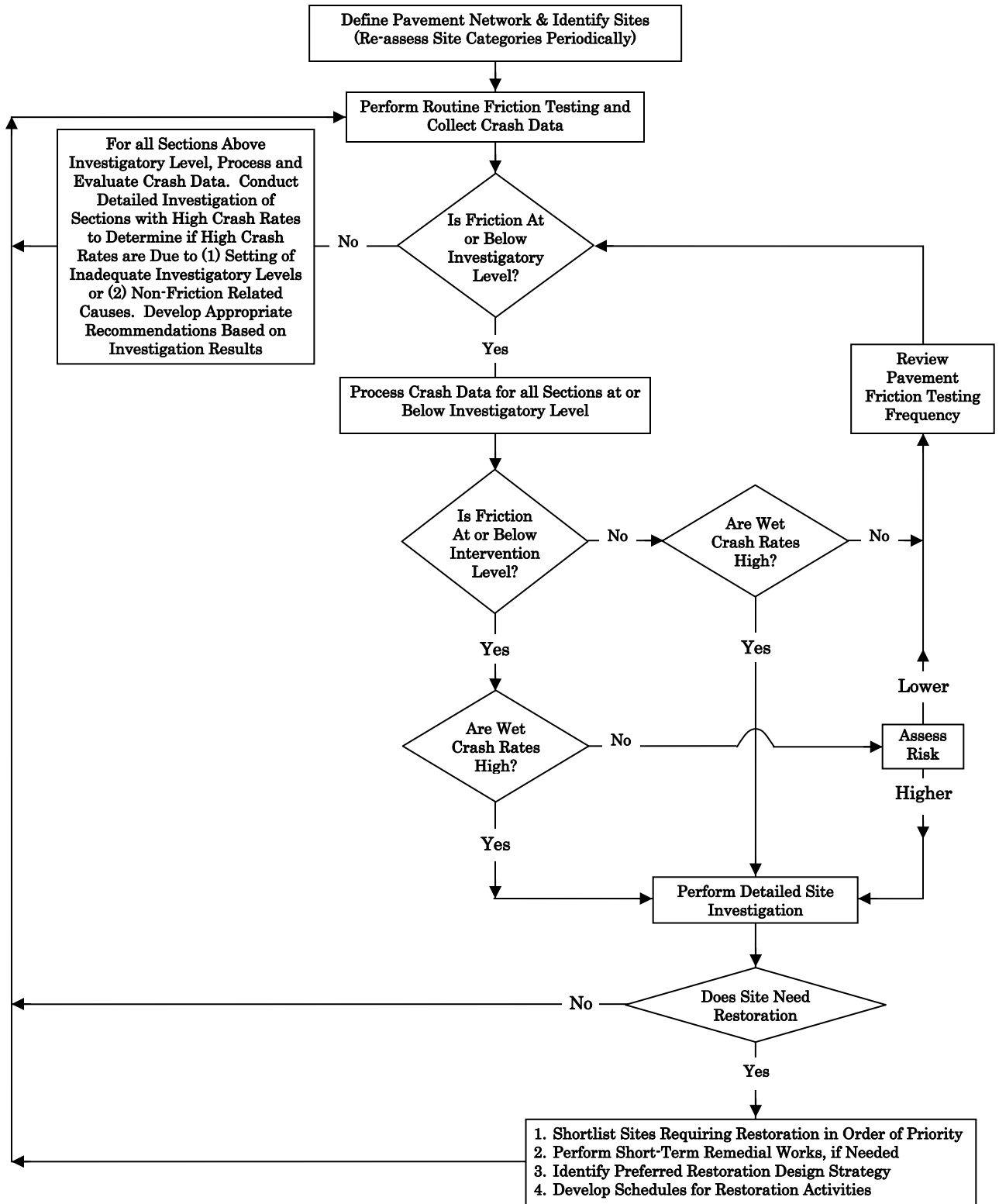

Figure 36. Example PFM program.

- Network-Level Data Analysis—Analyze friction and/or crash data to assess overall network condition and identify friction deficiencies.
 - Establish investigatory and intervention levels for friction. Investigatory and intervention levels are defined, respectively, as levels that prompt the need for a detailed site investigation or the application of a friction restoration treatment.
 - Identify pavement sections requiring detailed site investigation or intervention.
- Detailed Site Investigation—Evaluate and test deficient pavement sections to determine causes and remedies.
 - Evaluate non-friction-related items, such as alignment, the layout of lanes, intersections, and traffic control devices, the presence, amount, and severity of pavement distresses, and longitudinal and transverse pavement profiles.
 - Assess current pavement friction characteristics, both in terms of micro-texture and macro-texture.
 - Identify deficiencies that must be addressed by restoration.
 - Identify uniform sections for restoration design over the project length.
- Selection and Prioritization of Short- and Long-Term Restoration Treatments—Plan and schedule friction restoration activities as part of overall pavement management process.
 - Identify candidate restoration techniques best suited to correct existing pavement deficiencies.
 - Compare costs and benefits of the different restoration alternatives over a defined analysis period.
 - Consider monetary and non-monetary factors and select one pavement rehabilitation strategy.

CHAPTER 6. PAVEMENT FRICTION DESIGN

INTRODUCTION

Although pavement friction design is a relatively small component of the overall pavement design process, it is particularly critical because of the safety issue. Its importance and complexity have increased over the years due to increased demands for safer roads and the desire for greater highway user comfort, which sometimes contradicts friction.

Friction design requires a thorough understanding of the factors that influence friction and knowledge of the materials and construction techniques (including equipment) that ultimately dictate initial and long-term friction. It also requires an understanding of the economic and engineering tradeoffs associated with different materials and techniques, such as the costs/benefits of utilizing one friction strategy over another and how each strategy impacts structural design and other functional aspects (e.g., noise, splash/spray).

Designing pavement surfaces so that they have adequate friction—whether as part of a new pavement structure or a rehabilitation activity—involves identifying materials and construction activities that produce an appropriate combination of micro-texture and macro-texture. The micro-texture is a function of the type of aggregate used in the surface mix, while the macro-texture is generally dictated by the gradation/size of the aggregate in the mix or the type of texturing applied to the surface of the in-place mix.

This chapter discusses in detail the issues of micro-texture and macro-texture, and how they form the basis for designing pavement surfaces for friction. Both the network policy aspects and the project-level engineering aspects of friction design are discussed, along with the economics and other pavement–tire interaction issues that often must be addressed.

FRICTION DESIGN POLICIES

Friction design policies represent a highway agency’s overall framework and procedural manner for ensuring that all pavement projects fully and properly account for friction needs. As evidenced by the survey carried out in this study (see table C-7 in appendix C), SHA policies largely focus on the selection and use of (a) aggregates for micro-texture and (b) paving mixtures and surface texturing techniques for macro-texture. Discussions about each of these aspects are provided below.

Consideration of Aggregate in Friction Design

As noted earlier, micro-texture plays a key role in the development of pavement–tire frictional forces and is primarily governed by the properties of the aggregate used in the surface. While asphalt binder and cement paste can affect micro-texture—particularly just after a surface mix is placed—it is aggregate that makes up the bulk of asphalt and concrete mixtures, and thus serves as the primary contact medium with the vehicle tires.

Aggregate generally is viewed as two distinct fractions—coarse aggregate and fine aggregate. Coarse aggregate pieces are greater than the No. 4 sieve (0.19 in [4.75 mm]), with most pieces between 0.375 and 1.5 in (9.5 and 38 mm). Fine aggregate, on the other hand, is the collection of natural or crushed/manufactured particles less than 0.19 in (4.75 mm), but greater than the No. 200 sieve (0.003 in [75 μ m]).

Aggregate testing and characterization must be targeted to the fraction(s) of aggregate in a mix that will control the frictional performance. In general, coarse aggregate controls the frictional properties of asphalt mixtures, while fine aggregate controls the frictional properties of concrete mixes. Exceptions include fine-graded asphalt mixes, where fine aggregates are in greater abundance, and concrete mixes in which coarse aggregates are either intentionally exposed at the time of construction (exposed aggregate concrete, porous concrete) or will become exposed in the future (diamond grinding/grooving, surface abrading).

Research by Dahir and Henry (1978), Kandhal and Parker (1998), and Folliard and Smith (2003), among others, indicates that the following aggregate properties have a significant influence on pavement friction performance:

- Hardness.
- Mineralogy (i.e., mineral composition and structure).
- Shape.
- Texture.
- Angularity.
- Abrasion Resistance.
- Polish Resistance.
- Soundness.

Aggregate hardness and mineralogy largely dictate the wear characteristics (i.e., durability, polish) of the aggregate. Aggregates that exhibit the highest levels of long-term friction are typically composed of hard, strongly bonded, interlocking mineral crystals (coarse grains) embedded in a matrix of softer minerals (Henry, 2000). The differences in grain size and hardness provide a constantly renewed abrasive surface because of differential wear rates and the breaking off of the harder grains from the softer matrix of softer minerals.

Aggregates made up of hard minerals alone typically resist wear and other forms of degradation, yet may polish easily when subjected to traffic. Aggregates made up of moderately soft minerals alone resist polishing, but wear quickly when subjected to traffic. Thus, while a wear-resistant aggregate is desired in the mixture, some wearing of the pavement surface must occur to ensure good levels of skid resistance (Davis, 2001).

As summarized in table 22, aggregate angularity, shape, and texture are important parameters for defining both micro-texture and macro-texture. Fine aggregates that exhibit angular edges and cubical or irregular shapes generally provide higher levels of micro-texture, whereas those with rounded edges or elongated shapes generally produce

Table 22. Effect of aggregate angularity, shape, and texture properties on pavement friction.

Aggregate Fraction	Aggregate Property	Effect of Aggregate Property on Pavement Friction	
		Asphalt Surface	Concrete Surface
Fine	Angularity and shape	No effect.	Defines pavement micro-texture, which highly impacts friction.
	Texture	No effect.	Little to no effect.
Coarse	Angularity and shape	Defines pavement macro-texture, which significantly impacts friction via hydroplaning potential.	If exposed, helps define pavement macro-texture, which impacts friction via hydroplaning potential.
	Texture	Defines pavement micro-texture, which highly impacts friction.	If exposed, helps define pavement micro-texture, which impacts friction.

lower micro-texture. For coarse aggregates, sharp and angular particles interlock and produce a deep macro-texture as compared to more rounded, smooth particles. Moreover, in asphalt mixes, platy (i.e., flat and elongated) aggregate particles tend to orient themselves horizontally, resulting in lower macro-texture depth.

The abrasion resistance of aggregates is an indicator of their resistance to mechanical degradation. The use of abrasion-resistant aggregates is important to avoid the breakdown of fine and/or coarse aggregates. During handling, stockpiling, mixing, and construction, the breakdown of fine and/or coarse aggregates can significantly alter the mix gradation, thereby affecting the porosity of open-graded friction course (OGFC) asphalt mixes and porous concrete mixes. For concrete mixes, it can result in the loss of strength due to the production of excess fines in the concrete mix. In asphalt mixes, the increase in fines can alter the volumetric properties and result in insufficient binder or may contribute to rutting and shoving. After construction, the breakdown of fine and/or coarse aggregates due to traffic shear forces can result in a loss of macro-texture.

Polish-resistant aggregates are those that retain their micro-texture under the grinding and shearing effects of repeated traffic loadings. For asphalt surface mixes, it is the hardness and mineralogy of the coarse aggregate particles that determine the degree of polishing that takes place. For concrete mixes, because the surface is composed primarily of mortar and is initially devoid of coarse aggregates, the polishing resistance of fine aggregates is the most critical parameter (Folliard and Smith, 2003). The coarse aggregate becomes an influencing factor only if it is made or becomes exposed.

Soundness refers to an aggregate's ability to resist degradation caused by climatic/ environmental effects (i.e., wetting and drying, freezing and thawing). Similar to abrasion resistance, sound and durable aggregate properties are important for avoiding the breakdown of fine and/or coarse aggregates, particularly when used in harsh climates.

Aggregate Tests

Many laboratory material tests were noted in the literature as pertinent in defining aggregate frictional properties. Many of these same tests were reported in the state friction

survey (see listing in appendix C) as being used to ensure the use of aggregates with good frictional properties.

Several of the tests cited may be conducted for reasons other than friction performance. For example, for concrete pavements, mineralogical tests are very important in assessing the potential development of alkali-aggregate reactivity, D-cracking, and spalling. For asphalt pavements, coarse and fine aggregate particle shape and texture are good indicators of permanent deformation and fatigue cracking potential.

Based on recent thorough evaluations of aggregate tests related to performance (Kandhal and Parker, 1998; Folliard and Smith, 2003) and the proactive work of various states—Maryland, Michigan, Ohio, New York, and Texas, to name a few—the following tests are considered most relevant in characterizing frictional properties and potential performance.

- Scratch Hardness (Mohs).
- Petrographic Analysis (ASTM C 295).
- Uncompacted Voids (UV) for Fine Aggregate (AASHTO T 304 or ASTM C 1252).
- UV for Coarse Aggregate (AASHTO T 326).
- Fractured-Face Particles (ASTM D 5821).
- Micro-Deval for Fine Aggregates (Canadian Standards Association [CSA] A23.2-23A).
- Micro-Deval for Coarse Aggregates (AASHTO TP 58 or ASTM D 6928).
- LA Abrasion (AASHTO T 96 or ASTM C 131 for small-sized coarse aggregates; ASTM C 535 for large-sized coarse aggregates).
- Acid Insoluble Residue (AIR) (ASTM D 3042).
- Polished Stone Value (PSV) (AASHTO T 278 and T 279 or ASTM E 303 and D 3319).
- Magnesium Sulfate Soundness (AASHTO T 104 or ASTM C 88).

Table 23 provides a brief description of these tests and shows their recommended applications. Further discussion about the selection of tests is provided below. It is important to note that no individual test provides a full and accurate prediction of friction performance. Selecting and using multiple tests will increase the reliability, but even then there is no total guarantee of friction performance in the field. Thus, it is essential that testing be used in conjunction with field performance history to identify acceptable aggregate types.

Aggregate Composition/Structure and Mineral Hardness

While a visual inspection (using the descriptive nomenclature in ASTM C 294) of the aggregate can provide a basic understanding of mineral composition and structure, more detailed information can be obtained through advanced testing using petrographic analysis (ASTM C 295). Among other things, petrographic analysis provides important information on the types and relative amounts of constituent minerals comprising an aggregate. Although the Mohs hardness test can be performed on the individual mineral components, an experienced petrographer will know the approximate hardness values of each component. Thus, a range of hardness can be established, as can the proportion of hard versus soft minerals.

Table 23. Test methods for characterizing aggregate frictional properties.

Aggregate Property	Aggregate Type	Test Name	Test Protocol	Test Description	Applications
Hardness	Fine	Scratch Hardness test	Mohs	Rough measure of the resistance of a mineral's surface to scratching. Expressed using a 1-to-10 scale (1 being very soft, 10 being very hard), Mohs hardness is determined by observing whether its surface is scratched by minerals of a known or defined hardness.	<ul style="list-style-type: none"> • New concrete surfacings.
	Coarse	Scratch Hardness test	Mohs	Same as above.	<ul style="list-style-type: none"> • New asphalt surfacings and asphalt mixes used for friction restoration. • New concrete surfacings (conventional and innovative).^a
Mineralogy (i.e., Aggregate Composition & Structure)	Fine	Descriptive Nomenclature for Constituents of Concrete Aggregates	ASTM C 294	Provides brief descriptions of commonly occurring natural or artificial aggregates from which mineral aggregates are derived. The descriptions provide a basis for understanding the potential effects on pavement friction of using different aggregate materials.	<ul style="list-style-type: none"> • New concrete surfacings.
		Petrographic Analysis	ASTM C 295	Used to assess aggregate (1) constituent minerals and structure, (2) surface texture, and (3) mineralogy, and to develop a petrographic database for aggregate sources to serve as a basis for linking aggregate sources to pavement field performance (Folliard and Smith, 2003).	
	Coarse	Descriptive Nomenclature for Constituents of Concrete Aggregates	ASTM C 294	Same as above.	<ul style="list-style-type: none"> • New asphalt surfacings and asphalt mixes used for friction restoration. • New concrete surfacings (conventional and innovative).^a
		Petrographic Analysis	ASTM C 295	Same as above	

^a For conventional PCC surfaces, where coarse aggregates are expected to be exposed, and innovative surfaces, such as porous concrete and exposed aggregate concrete.

Table 23. Test methods for characterizing aggregate frictional properties (continued).

Aggregate Property	Aggregate Type	Test Name	Test Protocol	Test Description	Applications
Angularity, Shape, & Texture	Fine	Uncompacted Voids (UV) test for fine aggregates	AASHTO T 304 (or ASTM C 1252)	Fine aggregate of prescribed gradation is allowed to flow through orifice of a funnel and fill a 6.1-in ³ (100-cm ³) cylinder. Excess material is struck off and cylinder with aggregate is weighed. Uncompacted void content is computed using this weight and the bulk dry specific gravity of the aggregate (Kandhal et al., 1997). Higher uncompacted void contents are generally the result of more fractured faces and rougher textures, which are desirable for pavement friction.	<ul style="list-style-type: none"> • New concrete surfacings.
	Coarse	Uncompacted Voids (UV) test for coarse aggregates	AASHTO T 326 ^b	Coarse aggregate angularity, shape, and texture can be determined using principles similar to those described above for fine aggregates. Again, higher uncompacted void contents are generally the result of more fractured faces and rougher textures, which are desirable for pavement friction.	<ul style="list-style-type: none"> • New asphalt surfacings and asphalt mixes used for friction restoration. • New concrete surfacings (conventional and innovative).^a
		Fractured-Face Particles test	ASTM D 5821	Determines the amount (percent) of fractured-faced (an angular, rough, or broken surface of an aggregate particle) aggregate particles, by visual inspection. The fractured face of each aggregate particle must meet a minimum cross-sectional area.	<ul style="list-style-type: none"> • New asphalt surfacings and asphalt mixes used for friction restoration. • New concrete surfacings (conventional and innovative).^a
Abrasion/Wear Resistance	Fine	Micro-Deval test for fine aggregates	Canadian Standards Association (CSA) A23.2-23A	A fine aggregate sample is subjected to wet attrition by placing it in a steel jar with 0.375-in (9.5-mm) diameter steel balls and water. The jar is rotated at 100 rpm for 15 minutes, after which aggregate damage is assessed by mass loss using a No. 200 (75 µm) sieve. Higher percentages of loss indicate greater potential for aggregate breakdown (Folliard and Smith, 2003).	<ul style="list-style-type: none"> • New concrete surfacings (conventional).
	Coarse	LA Abrasion test	AASHTO T 96 (or ASTM C 131 [for small-sized coarse aggregates] ASTM C 535 [for large-sized coarse aggregates])	A dry aggregate sample is placed in a steel drum with six to twelve 420-gram steel balls, and the drum is rotated for 500 to 1,000 revolutions. Degradation by impact of the aggregate sample is determined by the percentage passing the No. 12 (1.7-mm) sieve.	<ul style="list-style-type: none"> • New asphalt surfacings and asphalt mixes used for friction restoration. • New concrete surfacings (conventional and innovative)^a
		Micro-Deval test for coarse aggregates	AASHTO TP 58 (or ASTM D 6928)	A coarse aggregate sample is subjected to wet attrition by placing it in a steel jar with 0.375-in (9.5-mm) diameter steel balls and water. The jar is rotated at 100 rpm for 2 hours, after which aggregate damage is assessed by mass loss using a No. 16 (1.18-mm) sieve.	<ul style="list-style-type: none"> • New asphalt surfacings and asphalt mixes used for friction restoration. • New concrete surfacings (conventional and innovative)^a

^a For conventional PCC surfaces, where coarse aggregates are expected to be exposed, and innovative surfaces, such as porous concrete and exposed aggregate concrete.

^b Formerly AASHTO TP 56.

Table 23. Test methods for characterizing aggregate frictional properties (continued).

Aggregate Property	Aggregate Type	Test Name	Test Protocol	Test Description	Applications
Polish Resistance	Fine	Acid Insoluble Residue (AIR) test	ASTM D 3042	Estimates the percent by weight of insoluble, hard, non-carbonate residue in carbonate aggregates (e.g., limestone, dolomite), using hydrochloric acid solution to react the carbonates. Higher acid insoluble residue (AIR) values indicate larger percentages of siliceous minerals, which are considered more polish resistant than carbonate materials (Kandhal et al., 1997).	<ul style="list-style-type: none"> • New concrete surfacings.
	Coarse	Polished Stone Value (PSV) test	AASHTO T 278 & T 279 (or ASTM E 303 & D 3319)	Aggregate coupons (aggregates embedded in epoxy resin) are fabricated, subjected to accelerated polishing (using British polish wheel) for a specified time (usually 9 hrs), and then tested for frictional resistance (expressed as British Pendulum Number [BPN]) using the British Pendulum Tester. The BPN value associated with accelerated polishing is defined as the polished stone value (PSV), which is a quantitative representation of the aggregate's terminal frictional characteristics. Higher values of PSV indicate greater resistance to polish.	<ul style="list-style-type: none"> • New asphalt surfacings and asphalt mixes used for friction restoration. • New concrete surfacings (conventional and innovative)^a
		Acid Insoluble Residue (AIR) test	ASTM D 3042	Same as above.	<ul style="list-style-type: none"> • New asphalt surfacings and asphalt mixes used for friction restoration. • New concrete surfacings (conventional and innovative)^a
Soundness	Fine	Magnesium Sulfate Soundness test	AASHTO T 104 (or ASTM C 88)	An aggregate sample is immersed in a solution of magnesium sulfate for a period of 16 to 18 hours at a temperature of 70°F (21°C). The sample is then removed, drained for 15 minutes, and oven-dried to a constant weight (5 cycles of immersion and drying is typical). During the immersion process, the salt solution penetrates the permeable pore spaces of the aggregate. Oven drying dehydrates the sulfate salt precipitated in the pores. The internal expansive force of the re-hydration upon re-immersion simulates the expansion of water upon freezing. Upon completion of the final cycle, the sample is sieved over various sieves and the maximum weighted average loss is reported as the sulfate soundness loss. Higher percentages of loss indicate less sound or durable aggregate (Khandal et al., 1997).	<ul style="list-style-type: none"> • New concrete surfacings.
	Coarse				<ul style="list-style-type: none"> • New asphalt surfacings and asphalt mixes used for friction restoration. • New concrete surfacings (conventional and innovative)^a

^a For conventional PCC surfaces, where coarse aggregates are expected to be exposed, and innovative surfaces, such as porous concrete and exposed aggregate concrete.

Aggregate Angularity, Shape, and Texture

The uncompacted voids (UV) test (AASHTO T 304 [ASTM C 1252]) is the most commonly used test for assessing fine aggregate angularity, sphericity, and texture (Folliard and Smith, 2003). As indicated by Meininger (1994), this test does not require performing detailed petrographic evaluations of shape and texture.

Three feasible options for assessing coarse aggregates are the fractured-face particles test (ASTM D 5821), the UV test (AASHTO T 326 [formerly AASHTO TP 56]), and the flat/elongated particles test. Highway agencies use both the fractured-face and flat/elongated particles tests extensively, primarily for controlling rutting in asphalt mixes. Because there are concerns with the subjectivity of the former test, NCHRP Project 4-19 recommended the UV test as a replacement for it (Prowell et al., 2005). However, given that the UV test has yet to be adopted by any state, the option of either test is recommended. Furthermore, because it is believed that the fractured particles test conveys a better sense of the micro-texture characteristics of an aggregate as compared to the flat/elongated test, it is recommended over the flat/elongated test.

Abrasion/Wear Resistance

While the Micro-Deval test (AASHTO TP 58 [ASTM D 6928]) for coarse aggregates has been reported to be a better indicator of the potential for aggregate breakdown (Folliard and Smith, 2003; Kandhal and Parker, 1998), the LA Abrasion test is commonly used with good success. Both tests are recommended.

Polish Resistance

There are no direct tests for assessing fine aggregate polish characteristics. The acid insoluble residue (AIR) test (ASTM D 3042), which indicates the amount of softer polishing carbonate material in an aggregate, is widely used and accepted, and has been reported to best relate to friction in concrete pavements. It is therefore recommended for fine aggregate. For coarse aggregates, both the AIR test and the polished stone value (PSV) test (AASHTO T 278 & T 279 [ASTM E 303 & D 3319]) have been used with good success. Both tests are recommended.

Feasible alternatives to the AIR and PSV tests exist—some old, some new; some standard, some non-standard. The Tennessee Terminal Textural Condition Method (T³CM), for instance, developed in the mid-1990s, utilizes the LA abrasion device and a modified version of the UV test apparatus to assess the texture retention characteristics of an aggregate (Crouch et al., 1996). Aggregates with good micro-texture and micro-texture retention characteristics exhibit higher UV contents and smaller reductions in loss when subjected to LA abrasion aging revolutions. The Tennessee DOT has used the T³CM test with fairly good success for several years and an improved version of the test (termed MDV9) that utilizes the Micro-Deval abrasion apparatus has been developed and evaluated (Crouch and Dunn, 2005).

Other test alternatives include Circular Track Polishing tests. Like the PSV test, these tests consist of polishing an aggregate sample using an accelerated polishing device and then evaluating the micro-texture of the aggregate using a friction testing device. Three

particular tests examined in this study include the North Carolina State University (NCSU) wear and polishing test (represented by ASTM standard E 660, *Standard Practice for Accelerated Polishing of Aggregates or Pavement Surfaces Using a Small-Wheel, Circular Track Polishing Machine*), the Michigan aggregate wear test, and the NCAT polishing test.

The polishing devices used in these tests are bigger than the accelerated polishing machine (APM) used in the PSV test, with polishing tracks ranging from about 12 in (305 mm) (NCAT device) to 7 ft (2.1 m) (Michigan device) in diameter and test tires ranging from 8 in (203 mm) in diameter (NCAT device) to full-scale smooth friction test tires (Michigan device). Although the size, configuration, and operation of these devices appear to simulate real-world conditions better than the APM, the equipment and operational costs tend to be greater than the APM.

At issue also is the availability and usage of the various polishing-type tests. McDaniel and Coree (2003) reported that, although ASTM E 660 was re-approved in 2002, it is not being used by the university or the North Carolina DOT. Furthermore, as per the survey results of this study, no states reported using the ASTM E 660 test. Though the Michigan DOT has reported good success with the Michigan aggregate wear test (which uses a laboratory version of the ASTM towed friction tester), it is the only agency that uses it.

The NCAT test is primarily designed for mixture samples instead of aggregate samples. Nominal 20-in (508 mm) square slabs are polished and tested with the DFT and CTM, resulting in both micro-texture and macro-texture assessments of the prepared mix. This test is more appropriate for use as a mix design and/or QC/QA test.

Soundness

The test method considered to best characterize aggregate soundness is the sulfate soundness test (AASHTO T 104 [ASTM C 88]). This widely used test was developed to simulate, without the need for refrigeration equipment, the effects of freeze-thaw water action on aggregate particles (Khandal and Parker, 1998).

Two options for sulfate solution are given in this test—sodium sulfate and magnesium sulfate. The preferred option is the latter, as it has been reported to produce less variation in mass loss (Folliard and Smith, 2003) and provide a better indication of good versus poor aggregates (Kandhal and Parker, 1998).

Aggregate Test Criteria

Just as no single test can distinguish good friction performance from bad, no single test value can be used as a standard for the same purpose. The factors that influence friction performance do so in an interactive manner and on a continuous scale, making it difficult to pinpoint specific discrimination values.

Nevertheless, research and current practices shed light on what can be considered as basic guidance in establishing friction performance-related test criteria. Table 24 provides

Table 24. Typical range of test values for aggregate properties.

Aggregate Property	Aggregate Fraction	Test Type	Typical Property Range for Good Friction Performance ^a	Supporting Documentation
Hardness	Fine	Mohs Scratch Hardness	≥ 6	<ul style="list-style-type: none"> Dahir and Henry (1978) provided Mohs hardness values for a variety of minerals, as follows: Diamond: 10 Feldspar: 6 - 6.5 Corundum: 9 Pyroxene Group: 5 - 7 Topaz: 8 Amphibole Group: 4 - 6.5 Sillimanite: 7.5 Apatite: 5 Cordierite: 7 - 7.5 Zeolites: 3.5 - 5.5 Quartz: 7 Flourite: 4 Garnet Group: 6.5 - 7.5 Dolomite: 3.5 - 4 Olivine Group: 6.5 - 7 Calcite: 3 Epidote Group: 6 - 7 Gypsum: 2 Chalcedony: 6 As noted by Dahir and Henry (1978), arbitrarily, but rather widely, Mohs Hardness of 5 has been used as dividing number between minerals termed as soft and those termed as hard. Dahir and Henry (1978) reported that aggregates made up of hard minerals (Mohs hardness ≥ 6) alone typically resist wear and other forms of degradation, yet may polish easily when subjected to traffic. Aggregates made up of moderately soft minerals (Mohs hardness of 3 to 6) alone resist polishing, but wear quickly when subjected to traffic. The ideal coarse aggregate should consist of 50 to 70 percent coarse-grained and hard minerals embedded in a matrix of 30 to 50 percent softer minerals (Dahir and Henry, 1978). Coarse aggregates that contain larger and more angular mineral grains or crystals exhibit higher levels of micro-texture and have a higher frictional resistance.
	Coarse	Mohs Scratch Hardness	Hard minerals: ≥ 6 Soft minerals: 3 to 5 Differential hardness (hard minus soft): 2 to 3	
Aggregate Composition & Structure	Fine	Visual Examination (Constituents of Concrete Aggregates) and Petrographic Analysis	Hard siliceous mineral aggregate	
	Coarse	Visual Examination (Constituents of Concrete Aggregates) and Petrographic Analysis	<u>Percent of Hard Fraction</u> Natural Aggregate: 50 to 70 Artificial Aggregate: 20 to 40 <u>Hard Grain or Crystal Size</u> 150 to 300 μm, average 200 μm <u>Hard Grain or Crystal Shape</u> Angular Tips	

Table 24. Typical range of test values for aggregate properties (continued).

Aggregate Property	Aggregate Fraction	Test Type	Typical Property Range for Good Friction Performance ^a	Supporting Documentation
Angularity, Shape, & Texture	Fine	Uncompacted Voids content, %	≥ 45	<ul style="list-style-type: none"> Guideline value of 45% minimum is based solely on addressing permanent deformation concerns (as noted by Prowell et al. [2005], several studies have supported the 45% minimum criteria). No research was available to indicate what minimum value should be used from a friction performance standpoint.
	Coarse	Uncompacted Voids content, %	≥ 45	
		Fractured-Face Particles	Agg. Particle Size: 0.12 to 0.5 in (3 to 13 mm) Agg. Particle Shape: Conical, Angular At least 90% by weight of the combined aggregates retained on No. 4 (4.75 mm) sieve should have two or more mechanically fractured faces.	<ul style="list-style-type: none"> Guideline value of 90% minimum is based on addressing rutting potential (as suggested by Prowell et al. [2005], a reasonable minimum target for high traffic pavements is 95% with two or more crushed faces). No research was available to indicate what minimum criteria should be used from a friction performance standpoint.
Abrasion/Wear Resistance	Fine	Micro-Deval, % Loss	≤ 17 to 20	<ul style="list-style-type: none"> Research performed under NCHRP Project 4-19 (Kandhal and Parker, 1998) resulted in a recommendation of 18% as the maximum allowable percentage loss. Ontario has longstanding requirement of 17% for aggregate used in surface courses (Kandhal and Parker, 1998).
	Coarse	Micro-Deval, % Loss	≤ 17 to 20	
		LA Abrasion, % Loss	≤ 35 to 45	<ul style="list-style-type: none"> As reported by Prowell et al. (2005), the LA abrasion test is used extensively by state agencies, with specification values ranging from 30 to 55% maximum and the most frequently cited specification value being 40% maximum Wu et al. (1998) reported that majority of states have a maximum allowable loss of 40 or 45%, and noted that criteria are more restrictive for surface courses than base courses. FHWA (2005) recommended range of 35 to 45% as maximum loss using the LA Abrasion test.

Table 24. Typical range of test values for aggregate properties (continued).

Aggregate Property	Aggregate Fraction	Test Type	Typical Property Range for Good Friction Performance ^a	Supporting Documentation
Polish Resistance	Fine	Acid Insoluble Residue (AIR), %	≥ 50 to 70	<ul style="list-style-type: none"> Dahir and Henry (1978) recommended 50 to 70 percent minimum for heavily traveled pavements. According to Liang (2003), Kentucky DOT specifies 50% minimum for class A aggregate sources. Liang and Chyi (2000) reported that New York DOT requires minimum of 15% for ADT greater than 3,000 veh/day.
	Coarse	AIR, %	≥ 50 to 70	
			Polished Stone Value (PSV)	≥ 30 to 35
Soundness	Fine	Magnesium Sulfate Soundness (5 cycles), % Loss	≤ 10 to 20	<ul style="list-style-type: none"> While Kandhal et al. (1997) reported a fairly wide range (10 to 30) in the maximum percentage loss specified by some states, subsequent research performed under NCHRP Project 4-19 (Kandhal and Parker, 1998) resulted in a recommendation of 18% as the maximum value. FHWA (2005) recommended a range of 15 to 20% as the maximum loss using the magnesium sulfate test.
	Coarse	Magnesium Sulfate Soundness (5 cycles), % Loss	≤ 10 to 20	

guideline values in the form of acceptable ranges for the tests recommended in the previous section. It also presents and discusses the source information used to support the guideline criteria. The information presented pertains to typical virgin aggregates and may not apply to lightweight, heavyweight, or recycled aggregates.

Surface Mix Types and Texturing Techniques

Pavement surface drainage is in part a function of the surface macro-texture, which is defined largely by the aggregate gradation characteristics and finish quality of the surface mix. Surfaces with greater amounts of macro-texture provide greater resistance to sliding via hysteresis, and they help facilitate drainage, thereby reducing the potential for hydroplaning.

Several different surface mix types and finishing/texturing techniques are available for use in constructing new pavements and overlays, or for restoring friction on existing pavements. Tables 25 and 26 describe the commonly used mix types and texturing techniques, respectively, and they present the typical macro-texture levels achieved. Pavement–tire considerations, such as noise, splash/spray, and hydroplaning, and general considerations, such as constructability, cost, and structural performance, are not discussed here, but they are an integral part of any policies developed for these mixes and texturing techniques.

Design Policy for Friction and Texture

The way aggregates and/or surface mixtures/textures are specified and selected for pavement projects, varies widely throughout the U.S. While the survey conducted in this study provides some indication of current practices, an earlier survey by Jayawickrama et al. (1996) provided an insightful characterization of friction design practices that most likely hasn't changed. The approaches are categorized as follows:

- **Category I—No Specific Guidelines to Address Skid Resistance.** Experience indicates that no prior classification of aggregates is necessary and, as such, no special procedure is followed to ascertain that the frictional characteristics of the aggregate used are satisfactory. The primary reason cited for such a policy is the availability of good quality aggregates.
- **Category II—Skid Resistance is Accounted for Through Mix Design.** States in this category also don't use any procedure to evaluate aggregate frictional properties. Instead, they base their friction policies on proper mix design. Again, experience shows that these states have no major problems related to pavement friction.
- **Category III—No Specific Guidelines to Address Skid Resistance.** States in this category consider friction of surface courses in the design of new pavements. Sufficient friction is obtained by controlling the quality of aggregate used in the construction of the pavement surface courses. Quality of the aggregates is controlled through experience by specifying the type and allowable percentages of a particular type of aggregate.

Table 25. Asphalt pavement surface mix types and texturing techniques.

Application	Mix/ Texture Type	Description	Macro-texture Depth ^a
New AC or AC Overlay	Dense Fine-Graded HMA	Dense-graded HMA is a dense, continuously graded mixture of coarse and fine aggregates, mineral filler, and asphalt cement (5 to 6 percent). It is produced in a hot-mix plant, delivered, spread, and compacted on site. Dense-graded HMA can be modified with polymers or crumb rubber ^b , and may include recycled materials. Nominal maximum sizes for surfacing applications can range from 0.38 in (9.5 mm) to 0.75 in (19.0 mm). Fine HMA mixes contain gradations that pass above the maximum density line (MDL) at the No. 8 (2.36-mm) sieve (WSDOT, 2005).	Typically ranges from 0.015 to 0.025 in (0.4 to 0.6 mm)
	Dense Coarse-Graded HMA	Coarse HMA mixes have gradations that pass below the MDL at the No. 8 sieve (2.36-mm) (WSDOT, 2005).	Typically ranges from 0.025 to 0.05 in (0.6 to 1.2 mm)
	Gap-Graded HMA or Stone Matrix Asphalt (SMA) ^b	SMA is a gap-graded mixture of coarse aggregate (typically, 0.4 to 0.6 in [10 to 15 mm]), filler, fibers and polymer-modified asphalt (typically, between 6 and 9 percent) produced in a hot-mix plant. Its primary advantage is resistance to deformation, but its relatively coarse surface yields good frictional characteristics.	Typically exceeds 0.04 in (1.0 mm).
	Open-Graded HMA or Open-Graded Friction Course (OGFC) ^b	OGFC is an open-graded mixture of mostly coarse aggregate, mineral filler, and asphalt cement (3 to 6 percent). It is produced in a hot-mix plant, contains a high percentage of air voids (17-22 percent) in the mix, and is spread and compacted on site. Friction, texture, and drainage properties can be controlled by the aggregate gradation, size, angularity, and type. Open-graded HMA can be modified with polymers, fibers, and/or crumb rubber ^c .	Typically ranges from 0.06 to 0.14 in (1.5 to 3.0 mm)

^a Based in part on Hanson and Prowell, 2004; Meegoda et al., 2002; FHWA, 1996; FHWA, 2005; Richardson, 1999.

^b Fine- and coarse-graded SMAs and OGFCs are being developed and increasingly used.

^c Crumb rubber asphalt is a blend of 5 to 10 percent asphalt cement, reclaimed tire rubber, and additives in which the rubber component is 15 to 20 percent by weight of the total blend. The rubber must react in the hot asphalt cement sufficiently to cause swelling of the rubber particles.

Table 25. Asphalt pavement surface mix types and texturing techniques (continued).

Application	Mix/ Texture Type	Description	Macro-texture Depth ^a
Friction Restoration of Existing AC Pavement	Chip Seal	Thin surface treatment containing single-sized, high-quality, angular aggregates (0.38 to 0.63 in [9.5 to 15 mm]), spread over and rolled into a liquid asphalt or asphalt emulsion binder. Aggregates are sometimes pre-coated with asphalt emulsion prior to spreading. Completed surface is somewhat coarse, yielding good frictional characteristics.	Typically exceeds 0.04 in (1 mm).
	Slurry Seal	Slurry mixtures of fine aggregate, mineral filler, and asphalt emulsion. They are similar to micro-surfacing, without interlocking aggregates. Polymers are not always used in the emulsion. Their surface is typically gritty.	Typically range from 0.01 to 0.025 in (0.3 to 0.6 mm).
	Micro-Surfacing (polymer-modified slurry seal)	A slurry mixture containing high-quality crushed, dense-graded aggregate, mineral filler, and polymer-modified asphalt emulsion. It is placed over a tack coat and is capable of being spread in variable thickness layers for rut-filling, correction courses, and wearing course applications.	Typically range from 0.02 to 0.04 in (0.5 to 1 mm).
	HMA Overlay	See HMA surface mixes above.	
	Ultra-Thin Polymer- Modified Asphalt (e.g., NovaChip)	Thin gap-graded asphalt surfaces placed using specialized equipment immediately over a thick polymer-modified asphalt emulsion membrane. Following slight compaction the surface provides a semi-porous texture.	Typically exceeds 0.04 in (1 mm).
	Epoxied Synthetic Treatment (e.g., Italgrip)	A very thin surface treatment consisting of a two-part polymer resin placed on an existing pavement and covered with a man-made aggregate of re-worked steel slag (0.12 to 0.16 in [3 to 4 mm]). The surface is designed to substantially improve the frictional characteristics of pavements.	Typically exceeds 0.06 in (1.5 mm).
Retexturing of Existing AC Pavement	Micro-Milling	Milling equipment, consisting of a self-propelled machine with carbide teeth mounted on a rotating drum, typically removes 0.75 to 1.25 in (19 to 32 mm) from the asphalt surface. Spacing of cuts is approximately 0.2 in (5 mm) versus 0.62-in (6-mm) cut of conventional cold-milling machines. Resulting surface has a fine, smooth pattern that gives smoother ride.	Typically exceeds 0.04 in (1 mm)

^a Based in part on FHWA, 1996; FHWA, 2005; Hanson and Prowell, 2004; Mockensturm, 2002; Wade et al., 2001; McNerney et al., 2000; HITEC, 2003; Gransberg and James, 2005; Yaron and Nesichi, 2005.

Table 26. Concrete pavement surface mix types and texturing techniques.

Application	Mix/ Texture Type	Description	Macro-texture Depth ^a
New PCC or PCC Overlay	Broom Drag (longitudinal or transverse)	A long-bristled broom is mechanically or manually dragged over the concrete surface in either the longitudinal or transverse direction. Texture properties are controlled by adjusting the broom angle, bristle properties (length, strength, density), and delay behind the paver. Uniform striations approximately 0.06 to 0.12 in (1.5 to 3.0 mm) deep are produced by this method.	Typically ranges from 0.008 to 0.016 in (0.2 to 0.4 mm).
	Artificial Turf Drag (longitudinal)	An inverted section of artificial turf is dragged longitudinally over a concrete surface following placement. Texture properties are controlled by raising/lowering the support boom, adding weight to the turf, and delaying application to allow surface hardening. This method produces uniform 0.06 to 0.12 in (1.5 to 3.0 mm) deep surface striations.	Typically ranges from 0.008 to 0.016 in (0.2 to 0.4 mm), but a deep texture (min depth of 0.04 in [1.0 mm]) has been specified ^b .
	Burlap Drag (longitudinal)	One or two layers of moistened coarse burlap sheeting are dragged over the concrete surface following placement. Texture properties are controlled by raising/lowering the support boom and adjusting the delay following concrete placement. This method produces uniform 0.06 to 0.12 in (1.5 to 3.0 mm) deep striations in the surface.	Typically ranges from 0.008 to 0.016 in (0.2 to 0.4 mm).
	Longitudinal Tine	A mechanical assembly drags a wire comb of tines (~ 5 in [127 mm] long and 10 ft [3 m] wide) behind the paver (and usually following a burlap or turf drag). Texture properties are controlled by the tine angle, tine length, tine spacing, and delay for surface curing. Grooves from 0.12 to 0.25 in (3 to 6 mm) deep and 0.12 in (3 mm) wide are produced by this method, typically spaced at 0.75 in (19 mm).	Typically ranges from 0.015 to 0.04 in (0.4 to 1.0 mm).
	Transverse Tine	Accomplished using methods similar to longitudinal tining, however, the mechanical assembly drags the wire comb perpendicular to the paving direction. Variations include skewing the tines 9 to 14° from perpendicular and using random or uniform tine spacing from 0.5 to 1.5 in (12 to 38 mm).	Typically ranges from 0.015 to 0.04 in (0.4 to 1.0 mm).

^a Based in part on Hoerner et al., 2003; Hoerner and Smith, 2002; FHWA, 1996; FHWA, 2005.

^b Minnesota Department of Transportation.

Table 26. Concrete pavement surface mix types and texturing techniques.

Application	Mix/ Texture Type	Description	Macro-texture Depth ^a
New PCC or PCC Overlay	Diamond Grinding (longitudinal)	A self-propelled grinding machine with a grinding head of gang-mounted diamond sawing blades removes 0.12 to 0.75 in (3 to 19 mm) of cured concrete surface, leaving a corduroy-type surface. Blades are typically 0.08 to 0.16 in (2 to 4 mm) wide and spaced 0.18 to 0.25 in (4.5 to 6 mm) apart, leaving 0.08 to 0.16 in (2 to 4 mm) high ridges. This method is most commonly used to restore surface characteristics of existing pavements, however, in recent years, it has been used to enhance the surface qualities of new PCC pavements or PCC overlays.	Typically ranges from 0.03 to 0.05 in (0.7 to 1.2 mm).
	Porous PCC	Gap-graded, small-diameter aggregate are combined with cement, polymers, and water to form a drainable surface layer (typically 8 in [200 mm] thick). That surface layer is bonded to the underlying wet or dry dense concrete layer. Texture properties are controlled by aggregate sizes and gradations. Air voids range from 15 to 25 percent.	Typically exceeds 0.04 in (1 mm).
	Exposed Aggregate PCC	A set retarder is applied to the wet concrete surface and the surface is protected for curing. After 12 to 24 hours, the unset mortar is removed to a depth of 0.04 to 0.08 in (1 to 2 mm) using a power broom. The large diameter aggregate is exposed by this process leaving a uniform surface.	Typically exceeds 0.035 in (0.9 mm).
Friction Restoration of Existing PCC Pavement ^b	HMA Overlay	See HMA surface mixes above.	
Retexturing of Existing PCC Pavement	Diamond Grinding (longitudinal)	See diamond grinding above.	
	Longitudinal Diamond Grooving	A self-propelled grooving machine saws longitudinal grooves in the road surface about 0.12 to 0.25 in (3 to 6 mm) deep and spaced 0.5 to 1.5 (13 to 38 mm) apart. This method adds macro-texture for drainage but relies on the original surface for micro-texture.	Typically ranges from 0.035 to 0.055 in (0.9 to 1.4 mm).
	Transverse Diamond Grooving	Completed in a manner similar to longitudinal diamond grooving, except the grooves are sawn transverse to the travel direction. This method also adds macro-texture and positive drainage for surface water. It relies on the original surface for micro-texture.	Typically ranges from 0.035 to 0.055 in (0.9 to 1.4 mm).
	Shot Abrading	An automated machine hurls recycled round steel abrasive material at the pavement surface, abrading the surface and/or removing the mortar and sand particles surrounding the coarse aggregate to a depth of up to 0.25 in (6 mm). Texture properties are controlled by adjusting the steel abrasive material velocity and approach angle and by modifying the forward equipment speed.	Typically ranges from 0.025 to 0.05 in (0.6 to 1.2 mm).

^a Based in part on Hoerner et al., 2003; Hoerner and Smith, 2002; FHWA, 1996; FHWA, 2005; HITEC, 2003; Rao et al., 1999.

^b Other treatments, such as micro-surfacing, ultra-thin polymer-modified asphalt, epoxy-bonded laminates, and thin-bonded PCC overlays, have been used but often have structural performance and/or cost issues.

- Category IV—Evaluate Aggregate Frictional Properties Using Laboratory Test Procedures. States in this category use laboratory tests, such as AIR, PSV, fractured particles, and soundness, to determine the acceptability of an aggregate or aggregate source for a particular job.
- Category V—Incorporates Field Performance in Aggregate Qualification—With shortcomings in the correlation between laboratory test results and actual field performance, some states incorporate a two-pronged design approach consisting of laboratory testing and historical field performance.

Thus, while some states are fortunate to have good quality aggregates or are less in need of special mixes or textures for macro-texture, others are compelled, at some level, to more fully evaluate and specify their aggregates and mixes/textures.

Presented in the sections below are some of the friction design practices reported in the literature and through the surveys and interviews with selected SHAs. The practices described represent examples of how traffic and other site conditions can be utilized in specifying aggregates and mixes/textures.

Illinois DOT

The Illinois DOT selects and designs pavement surfaces in accordance with the following criteria (Rowden, 2004):

- PCC Pavements: Final finishing on highways with posted speed limits in excess of 40 mi/hr (65 km/hr) receives a Type A final finish (transverse tining with 0.75-in [19-mm] spacing, 0.1- to 0.125-in [2.5- to 3.1-mm] width, and 0.125- to 0.19-in [3.1- to 4.8-mm] depth. Final finishing on highways with posted speed limits not exceeding 40 mph (65 km/hr) receives a Type A or Type B (artificial turf drag) final finish.
- HMAC Pavements: New surface courses must have friction qualities equivalent to or greater than those provided by the following guidelines. Traffic levels from the expected year of construction are used to determine the mixture.
 - Mixture C is used as the Class I surface course on roads and streets having an ADT of 5,000 veh/day or less.
 - Mixture D is used as the Class I surface course on two-lane roads and streets having an ADT greater than 5,000 veh/day, on four-lane highways having an ADT between 5,001 and 25,000 veh/day, and on six-lane (or greater) highways having an ADT of 60,000 veh/day or less.
 - Mixture E is used as the Class I surface course on four-lane highways having an ADT between 25,001 and 100,000 veh/day or on six-lane (or greater) highways having an ADT between 60,001 and 100,000 veh/day.
 - Mixture F is used as the Class I surface course on any facility having an ADT greater than 100,000 veh/day.

The HMAC specification describes the allowable coarse aggregates and proportions for use in each mixture type. For instance, aggregates for mixture C may consist of crushed gravel, crushed stone, crushed sandstone, crushed slag, crushed steel slag, or gravel (in certain instances). Aggregates for the highest mixture type (F), on the other hand, may only

consist of crushed gravel, crushed stone (except limestone), or adequately blended crushed sandstone.

Although the Department employs some friction-related lab tests, such as sodium sulfate soundness and LA Abrasion, they place much greater emphasis on testing friction in the field and linking the results to the respective aggregates/aggregate sources.

Louisiana DOT

Although the Louisiana DOT does not utilize a friction demand identification process, the Department does classify aggregates for asphalt mixtures according to four different friction ratings, that are based on PSV test results (Rasoulion, 2004). These friction rating categories are distinguished by layer and application, as illustrated below.

- Friction Rating 1 (all mixtures): PSV > 37.
- Friction Rating 2 (all mixtures): PSV = 35 to 37.
- Friction Rating 3 (all mixtures, except wearing courses with ADT > 7,000 veh/day): PSV = 30 to 34.
- Friction Rating 4 (all mixtures except wearing courses): PSV = 20 to 29.

Maryland SHA

Maryland ensures HMAC friction by recommending minimum levels of coarse aggregate PSV in the HMAC mixture. The actual PSV required to ensure adequate levels of pavement surface friction is dependent on friction demanded by a specific site (i.e., site category) and expected traffic level, as depicted in table 27 (Flintsch et al., 2002). According to the Maryland procedure, the use of limestone, marble, or serpent aggregates in the surface mixture is avoided regardless of their PSV value.

Table 27. Recommended levels of aggregate PSV for various site and friction requirement categories (Flintsch et al., 2002).

Site/Demand Category	PSV of Coarse Aggregates						Design FN
	Traffic (Heavy Commercial Vehicles per Lane per Day)						
	250	1,000	1,750	2,500	3,250	4,000	
1—Approach railroad crossing, traffic lights, pedestrian crossing, roundabouts, stop and give way controlled intersections.	7	7	8	8	9	9	55
2—Curves with radius <820 ft (250 m), downhill gradients >10 percent, and 164-ft (50-m) long freeway/highway on/off ramp.	6	7	7	8	8	9	50
3—Approach to intersections, downhill gradients 5 to 10%.	6	6	7	7	8	8	45
4—Undivided highways without any other geometrical constraints which influences frictional demand.	5	6	6	7	7	8	40
5—Divided highways without any other geometrical constraints which influences frictional demand.	5	5	6	6	7	7	35

Michigan DOT

Michigan determines the polishing potential of HMAC coarse aggregates for design of high-friction pavements through laboratory testing (wear track testing or petrographic analysis) (Skerritt, 2004). The wear-track testing program consists of a large-scale indoor polishing track and a tire-mounted friction tester. Aggregate test specimens are subjected to 4 million wheel passes on the wear track, during which surface friction is measured. The normalized value of friction at the end of the test is used to calculate an Aggregate Wear Index (AWI), which is a measure of the polishing potential of the aggregate source tested. Aggregates are specified for use as follows, based on anticipated traffic (Liang, 2003):

- ADT < 100 veh/day/lane: no AWI requirement.
- ADT \geq 100 and < 500 veh/day/lane: AWI \geq 220.
- ADT \geq 500 veh/day/lane: AWI \geq 260.

Pennsylvania DOT

All coarse aggregate sources approved by the Pennsylvania DOT are assigned a Skid Resistance Level (SRL) rating that is used to decide (for asphalt wearing courses only) what aggregate sources may be used in which wearing courses. The five levels of SRL ratings are defined as low (L), medium (M), good (G), high (H), and excellent (E). Based on the SRL, aggregates are specified for pavements with different ADT values as follows (Liang, 2003):

- ADT > 20,000 veh/day: E
- 5,000 < ADT < 20,000 veh/day: E, H, E/M blend, or E/G blend.
- 3,000 < ADT < 5,000 veh/day: E, H, G, H/M blend, or E/L blend
- 1,000 < ADT < 3,000 veh/day: E, H, G, M, H/L blend, G/L blend, or E/L blend
- ADT < 1,000 veh/day: Any

After the results of the above tests are available, they are evaluated and the SRL rating is assigned to the new aggregate source, based on the petrography of the aggregate, and how closely it matches that of older, petrographically similar aggregate sources whose skid performance is known from previous skid studies.

Texas DOT

Designing for friction in Texas begins with the identification of friction demand. The Texas DOT uses various factors for assessing overall friction demand, including rainfall, traffic, speed, trucks, grade, curves, intersections, cross slope, surface design life, and the macro-texture of the proposed surface (Stampley, 2004).

For asphalt pavements, the Department has developed an aggregate rating system that classifies coarse aggregate source materials into four categories (A, B, C, and D) to match their demand classifications. These ratings are updated semi-annually based on aggregate properties from approved resources (Texas DOT, 2004). Source aggregates are rated according to PSV, LA Abrasion, and magnesium sulfate soundness for HMAC and surface treatment applications. Suggestions for blending are also provided (Texas DOT, 2004).

Framework for Comprehensive Friction and Texture Policy

State highway agencies (SHAs) are encouraged to develop or update policies concerning the friction design of new and restored pavements. Such policies should clearly define the aggregate friction testing protocol (i.e., test types and criteria) and surface mix/texturing techniques that are applicable for the friction demand categories established in the PFM program.

As conceptually illustrated in figure 37, friction design categories should be established that link combinations of rated aggregate sources and agency mix types/texturing techniques with PFM sections having different levels of friction demand (defined by investigatory/intervention level). Each category should include a design friction level that takes into consideration expected friction loss over time due to aggregate polishing and/or macro-texture erosion.

As a minimum, friction design categories should be established according to highway design speed and traffic (or design loadings in terms of equivalent single axle loads [ESALs]), since these factors largely determine micro-texture and macro-texture needs. Other factors that could be used in establishing categories include roadway facility type (i.e., functional or highway class, access type), facility setting (rural, urban), climate (e.g., wet, dry), number of lanes, and truck percentages.

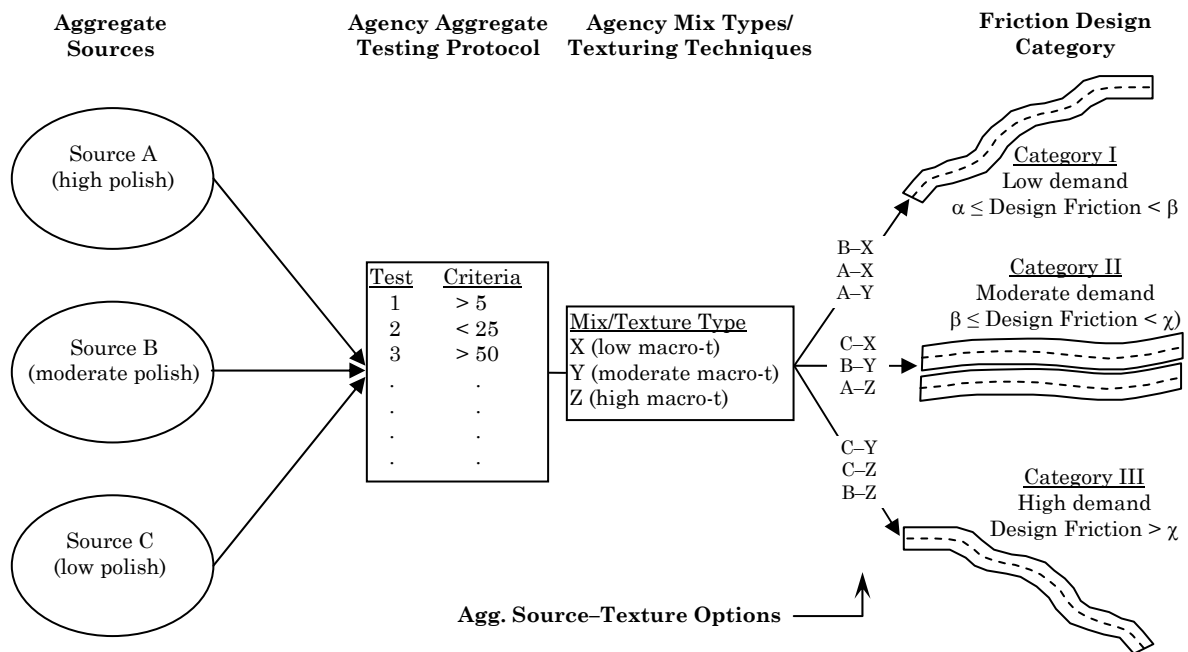

Figure 37. Example illustration of matching aggregate sources and mix types/texturing techniques to meet friction demand.

Although several factors can be used in establishing friction design categories, the number of categories should be limited to between three and five. When developing aggregate source–texture options for a given design category, economics should be considered from the standpoint that, if the local sources contain only low-polish aggregate, it may be justifiable to use such aggregate for low friction demand situations. In addition, agencies should be mindful of any existing classification schemes set forth in their wet-weather crash reduction programs, materials and/or construction specifications, or other pavement-related policies and systems, as they may reflect the desired friction priorities.

Once the design categories have been set, aggregate test protocols and mix/texture type options can be developed for each category, along with design friction levels. The test protocol should list the specific tests to be performed and the criteria/parameters to be used. The criteria should be based on established links between historical friction performance and laboratory test data.

PROJECT-LEVEL FRICTION DESIGN

Project-level friction design entails selecting aggregates and mix types/texturing techniques that satisfy both initial and long-term friction requirements. Although safety over the established pavement design life is the paramount concern, the design process should target a surface that most economically satisfies the following criteria:

- Adequate levels of micro-texture over the life of the pavement, as produced by sharp, gritty aggregate with low polish and high wear resistance characteristics.
- Adequate levels of macro-texture over the life of the pavement for efficient displacement of water on the pavement surface.
- Low levels of splash/spray, noise generation, glare, tire wear, and rolling resistance.

A five-step process for designing surfaces for new asphalt or concrete pavement, as well as restoration treatments of existing asphalt or concrete pavement, is as follows:

1. Determine design friction level.
2. Select aggregates.
3. Establish surface mix types and/or texturing techniques.
4. Develop construction specifications.
5. Formulate design strategies.

These design steps are described in detail in the sections below.

Step 1—Determining Design Friction Level

For each new construction or restoration project, a design friction level (expressed as $F(60)$ if IFI is used or as FN) must be selected to satisfy agency policy requirements. The selected design level must ensure that adequate amounts of micro-texture and macro-texture are available throughout the design period.

The selected design level should take into consideration the design levels of individual PFM sections. Either one overall level can be established for the project corresponding to the PFM section with the highest demand, or multiple levels can be used. In the latter case, care must be taken such that the multiple levels do not result in an excessive number of mix types and/or surface textures to be used along the project.

Once an agency sets the goal for friction for a particular project, the process of selecting aggregates and mix types/texturing techniques that satisfy the design friction level can begin. An initial list of aggregate source–texture options can be derived from the feasible combinations identified previously for each design category (e.g., B-X, A-X, and A-Y for design category I in figure 37). These, and other potential combinations, can be evaluated more thoroughly for adequacy using the IFI model, as described below in step 3.

Step 2—Selecting Aggregates

The most important factor in achieving long-lasting friction is aggregate selection. Aggregates should have the physical, chemical, and mechanical properties needed to satisfy both the initial and long-term friction requirements of a pavement project.

Aggregates must comply with an agency’s testing requirements. Aggregate samples should be tested early in a project to determine their suitability and compliance with specifications. Frequently, two or more aggregate sources must be combined in appropriate percentages to meet project gradation requirements. Aggregates not meeting the specified test parameters should be rejected (prior to any mix design effort) and either new materials should be considered and tested or a suitable blend of high- and low-polish susceptible aggregates should be identified.

As discussed earlier, micro-texture in asphalt surface mixes is provided by the coarse aggregate surface texture. Coarse aggregates that exhibit “rough sandpaper” surface textures provide higher levels of micro-texture than those with smooth “fine sandpaper” textures.

Micro-texture in concrete surfaces is generally provided by the fine aggregates in the cement mortar/paste (for concrete mixes with exposed aggregates, the surface properties of the coarse aggregate will dictate micro-texture). Fine aggregates that exhibit angular edges and cubical or irregular shapes generally provide higher levels of micro-texture, whereas those with rounded edges or elongated shapes generally produce lower micro-texture.

Aggregates comprised of a matrix of both hard and soft minerals offer a continuously renewable micro-texture that helps ensure friction durability. Ascertaining the long-term micro-texture of the selected aggregate is a crucial part of the design process. It generally entails either retrieving historical *PSV* test data (if available) for the aggregate or aggregate source in question or conducting formal *PSV* testing of the aggregate.

Step 3—Establishing Surface Mix Types and/or Texturing Techniques

Framework for Achieving Design Friction Level

As discussed earlier, potential combinations of aggregate source and mix type/texturing technique can be evaluated in detail using the IFI model (equations 9 through 11). Using $DFT(20)$ as a surrogate for micro-texture and the CTM to get MPD , $FR(S)$ in equation 10 can be set to $DFT(20)$ at S equal to 20 km/hr. Furthermore, substituting equation 9 into equation 10, one gets the following:

$$FR(60) = DFT(20) \times e^{\left(\frac{20-60}{14.2+89.7 \times MPD}\right)} \quad \text{Eq. 26}$$

Inserting equation 26 into equation 11, adding in the A , B , and C calibration constants (0.081, 0.732, and 0, respectively) for $DFT(20)$ as given in ASTM E 1960, and re-arranging to solve for $DFT(20)$, the following equation is obtained:

$$DFT(20) = \left[(F(60) - 0.081 - 0 \times MPD) / 0.732 \right] \times e^{\left(\frac{60-20}{14.2+89.7 \times MPD}\right)} \quad \text{Eq. 27}$$

Figure 38 is a plot of the above equation. As an example application, consider a project where it is desired that a locked-wheel smooth-tire friction test give a friction number of 40 at a speed limit of 60 km/hr. Then $F(60)$ is 40 and equation 27 becomes as follows:

$$DFT(20) = \left[(40 - 0.081) / 0.732 \right] \times e^{\left(\frac{40}{14.2+89.7 \times MPD}\right)} \quad \text{Eq. 28}$$

To achieve the design friction level of 40, the pairs of $DFT(20)$ and MPD given in table 28 are needed. The first pair includes a rather high $DFT(20)$ and the last two pairs include high MPD values. Therefore, the second and third pairs containing MPD values of 0.813 and 1.524 mm would need to be selected to give the $F(60)$ or FN needed.

If the polishing characteristics have been measured or are already known, higher levels of micro-texture and/or macro-texture should be selected to meet the required levels at the end of the design life. For example, if the polished $DFT(20)$ (i.e., PSV) and the MPD are satisfactory, then the initial $DFT(20)$ from the test would need to be specified. If the polished $DFT(20)$ is too low and thus requires a MPD that is too high to meet, then a higher $DFT(20)$ or different aggregate is needed to get the required polished $DFT(20)$ at the end of the design life.

This method is then a guide for evaluating the levels of micro-texture ($DFT(20)$) and macro-texture (MPD) needed to achieve the design friction level established for a project. It can be used directly in identifying a suitable combination(s) of aggregate and mix type/texturing technique for a project or it can serve as a framework for agencies interested in developing their own customized procedure. It should also be noted that a similar process utilizing the combination of BPN (micro-texture) and MTD (macro-texture) could be established and used.

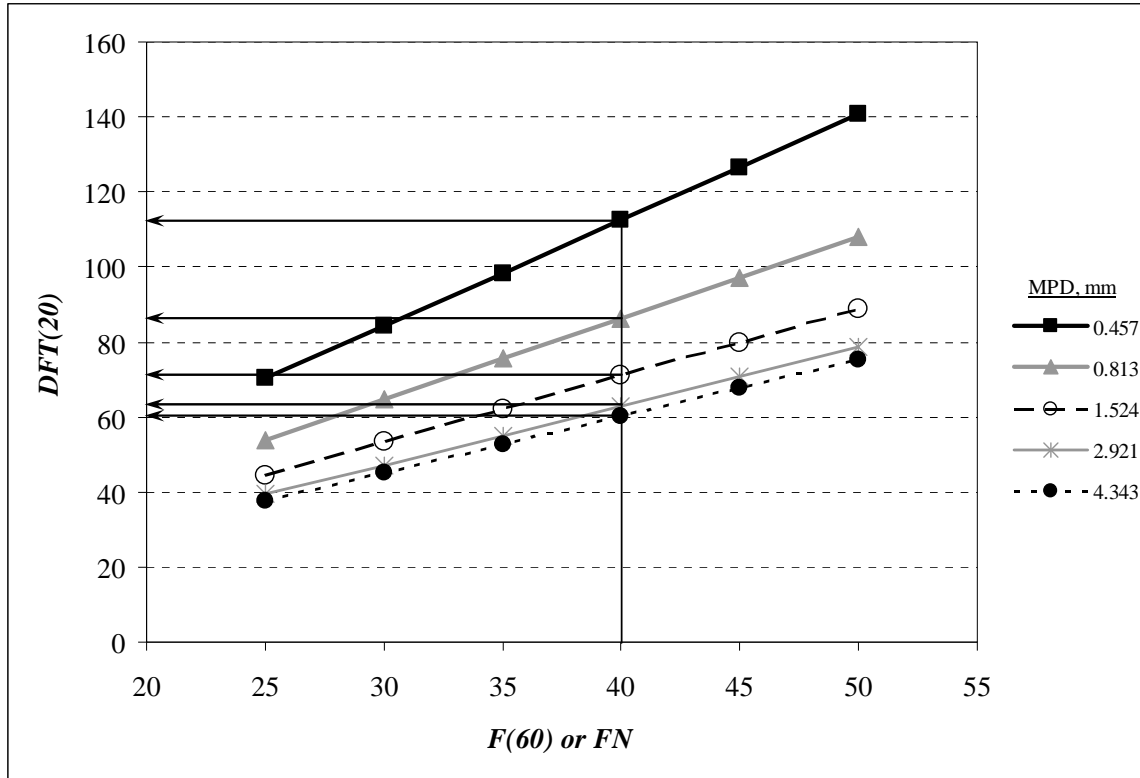

Figure 38. Example of determining $DFT(20)$ and MPD needed to achieve design friction level.

Table 28. Pairs of MPD and $DFT(20)$ needed to achieve design friction level of 40.

MPD , mm	0.457	0.813	1.524	2.921	4.343
$DFT(20)$	112.5	86.3	71.1	63.0	60.2

Detailed Consideration of Macro-texture in Friction Design

During the mix design stage of an asphalt project, there may become the need to “fine-tune” the gradation of a mix to satisfy the friction design requirement. A method for doing this was developed by Sullivan (2005). This method, illustrated in figure 39, uses PSV and MPD to compute IFI (as given in ASTM E 1960) and subsequently determine the design vehicle stopping distance. Figure 40 shows an example vehicle response chart for a selected speed of 50 mi/hr (80 km/hr).

The Sullivan method uses an equation for computing the MPD based on key asphalt mix characteristics (maximum aggregate size, gradation, binder content). While historical data on asphalt surface mix textures can be used in this process, the MPD equation (derived using comprehensive mix design and surface texture data from the NCAT test track) gives the mix designer greater flexibility in establishing a mix design that will meet friction requirements.

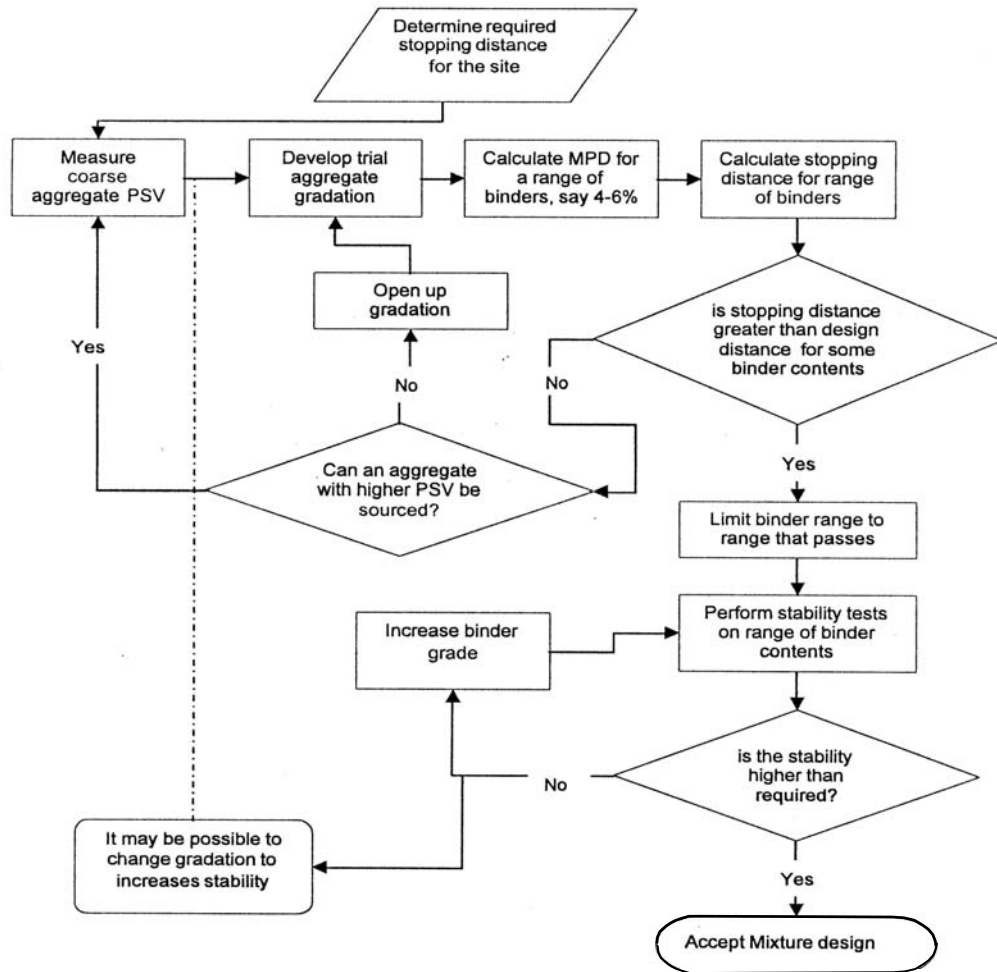

Figure 39. Asphalt pavement friction design methodology (Sullivan, 2005).

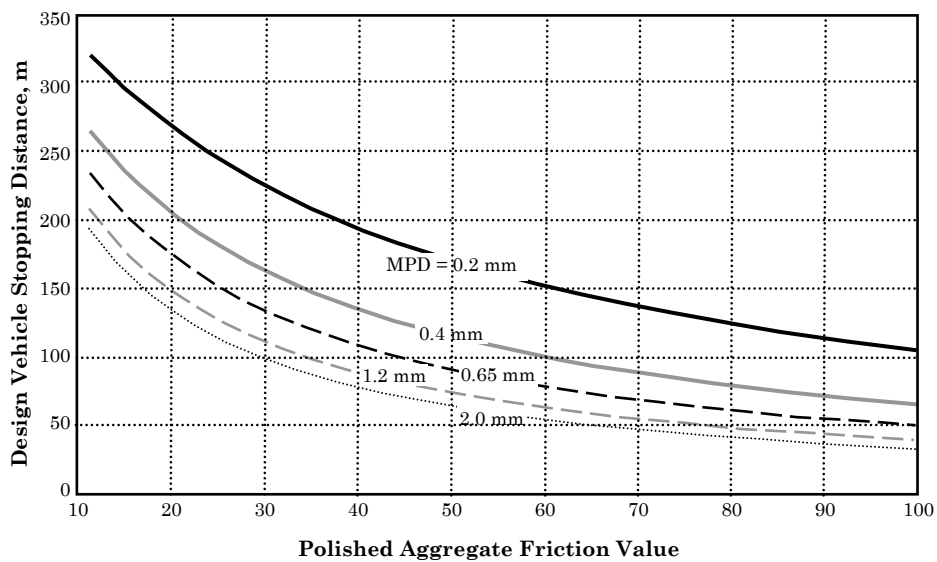

Figure 40. Vehicle response as function of PSV and MTD (Sullivan, 2005).

Although a similar process for conventional concrete mixes could be developed, it is not as important, since the macro-texture is designed separately from the micro-texture. However, agencies are encouraged to quantify the macro-texture (*MPD* or *MTD*) of both newly applied and in-service surface texturings (e.g., tined, grooved, or ground surfaces with different groove dimensions, spacings, and orientations), so as to ensure the right supplement for the chosen fine aggregate,

Asphalt Mix Design

Macro-texture in asphalt surface mixes (and exposed concrete surfaces) is primarily governed by the size and gradation of the aggregate used. Generally speaking, the larger the aggregates in the mix, the greater the macro-texture produced. Also influencing macro-texture are mix volumetric properties, such as voids in the mineral aggregate (VMA), voids in the total mix (VTM), and the percentage of aggregate passing the 0.38-in (9.5-mm) through No. 10 (2.36-mm) sieve sizes.

Mix type selection and design are important for identifying a mix with sufficient macro-texture (*MPD*) that, when combined with the aggregate *PSV*, satisfies the friction design requirements (Step 1). Further discussion about asphalt mix design, and in particular aggregate size/gradation and volumetric properties, is provided in the sections below.

Aggregate Size

Aggregate size may be qualified in terms of either maximum size (*MS*) or nominal maximum size (*NMS*). The *MS* of an aggregate is defined as the smallest sieve that all of a particular aggregate must pass through. The *NMS* of an aggregate is defined as the smallest sieve size through which the major portion of the aggregate must pass. The *NMS* sieve may retain 5 to 15 percent of the aggregate depending on the size number. Superpave defines *NMS* as one sieve size larger than the first sieve to retain more than 10 percent of the material (Roberts et al., 1996).

Aggregate Gradation

The gradations of commonly used asphalt surface mixes can be categorized and described as follows:

- Dense- or well-graded—Refers to a gradation that is near maximum density. The most common HMA mix designs tend to use either dense fine-graded or dense coarse-graded aggregate.
- Gap-graded—Refers to a gradation that contains only a small percentage of aggregate particles in the mid-size range. The curve is flat in the mid-size range. Gap-graded surface mixes include SMA and proprietary mixes such as NovaChip.
- Open-graded—Refers to a gradation that contains only a small percentage of aggregate particles in the small range. This results in more air voids because there are not enough small particles to fill in the voids between the larger particles. The curve is flat and near-zero in the small-size range. Open-graded surface mixes include OGFC.

- Uniformly graded—Refers to a gradation that contains most of the particles in a very narrow size range. In essence, all the particles are the same size. The curve is steep and only occupies the narrow size range specified. Common uniformly graded surface mixes include most slurry seals, micro-surfacing, and chip seals.

Figure 41 illustrates these four gradations. Note that dense fine-graded HMA mixes contain gradations that pass above the maximum density line (MDL) at the No. 8 (2.36-mm) sieve, whereas the gradations for dense coarse-graded HMA pass below the MDL at the No. 8 (2.36-mm) sieve.

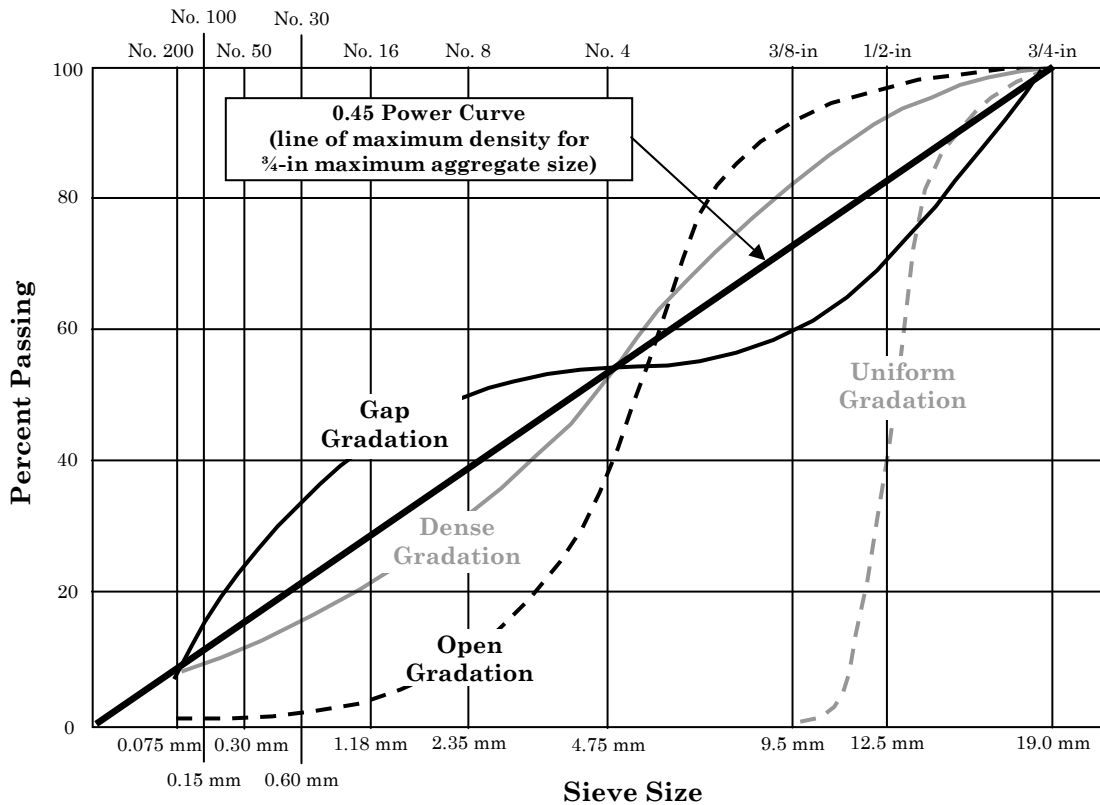

Figure 41. Typical asphalt mix aggregate gradations (WAPA, 2004).

Percentage of Aggregate Material Passing the 0.38-in (9.5-mm) through No. 10 (2.36-mm) Sieve Sizes

The percentage of material passing the 0.375-in (9.5-mm) through No. 10 (2.36-mm) sieve sizes affects the asphalt mix macro-texture. Evidence suggests that increasing the amount of material passing these sieve sizes reduces the asphalt mix macro-texture. Generally, the amount of aggregate passing these sieve sizes depends on the asphalt mix type (i.e., dense graded, open graded, and so on). To increase asphalt mix macro-texture, the lower bound values of agency recommendations for percentage of aggregate material passing these sieve sizes should be used.

Voids in the Mineral Aggregate (VMA)

Increasing the VMA increases macro-texture and porosity. Excessively high VMA can, however, adversely affect asphalt mix durability. Hence, increasing this asphalt mix property must be done with caution. Where a high VMA is required to meet macro-texture requirements or to ensure that the asphalt mix is open or porous, additives (i.e., polymers) can be added to the mix to increase durability.

Typically, a minimum VMA value ranging from 13 to 15 percent is specified for a dense aggregate mix. This value can be increased to enhance the asphalt mix macro-texture requirements by altering the packing characteristics of aggregate particles in the mix. In particular, lowering the minus No. 200 content in a mixture to the lower end of the specification or reducing the amount of aggregate particles between two successive sieves (i.e., gap grading) will increase VMA.

Estimating Texture Depth Using Mix Design Parameters

Several studies have been conducted attempting to model texture depth as a function of aggregate gradation/size characteristics and mix volumetric properties. Presented below are three particular models reported in the literature which could be considered for use in assessing macro-texture of laboratory-designed asphalt mixes.

- NCHRP Report 441 (Stroup-Gardiner and Brown, 2000)—The model below predicts estimated mean texture depth (*ETD*) based on aggregate size and gradation characteristics. As also shown, the sieve sizes associated with 10, 30, and 60 percent passing are used to compute the coefficients of uniformity and curvature (C_C and C_U , respectively).

$$EMTD = 0.0198 \times MS - 0.004984 \times P200 + 0.1038 \times C_C + 0.004861 \times C_U \quad \text{Eq. 29}$$

where: $EMTD$ = Estimated mean texture depth (computed using ROSANv laser texture measurement).

MS = Maximum size of the aggregate, mm.

$P200$ = Percentage passing No. 200 (4.75-mm) sieve.

$$C_C = \frac{D_{30}^2}{D_{10} \times D_{60}}$$

$$C_U = \frac{D_{60}}{D_{10}}$$

D_{10} = Sieve size associated with 10 percent passing, mm.

D_{30} = Sieve size associated with 30 percent passing, mm.

D_{60} = Sieve size associated with 60 percent passing, mm.

- Virginia Smart Road (Davis, 2001)— MPD at the Virginia Smart Road, as measured using a laser profiler, was analyzed according to mixture properties of the pavement to determine which properties had the largest effect on MPD . The equation resulting from the regression analysis is provided below. The regression coefficient for the equation was 0.9724, indicating an excellent fit.

$$MPD = -3.596 + 0.1796 \times NMS + 0.0913 \times P200 - 0.0294 \times VTM + 0.1503 \times VMA \quad \text{Eq. 30}$$

where: MPD = Mean profile depth.
 NMS = Nominal maximum size of the aggregate.
 $P200$ = Percentage passing No. 200 (4.75-mm) sieve.
 VTM = Total voids in the mixture.
 VMA = Voids in the mineral aggregate.

- NCAT-Derived Model (Sullivan, 2005)—The results of an evaluation of the effect of mix gradation and binder content on in-service surface texture measurements from 17 NCAT test mixes found that texture depth can be accurately estimated using binder content and the gradation's weighted mean distance from the MDL. The developed model is presented below. The correlation between predicted and measured texture depth (in the form of MPD) was excellent, with an R^2 of 0.96.

$$\Omega = \sum \left\{ \left[\left[(SivS/MaxAgg)^{0.45} \times 100 \right] - \%Pass \right] \times SivS \right\} \quad \text{Eq. 31}$$

where: Ω = Weighted distance from maximum density line.
 $SivS$ = Sieve size.
 $MaxAgg$ = Maximum aggregate size in mix.
 $\%Pass$ = Percent of mix passing the sieve size.

$$MPD = 0.025 \times \Omega^2 + 0.037 \times \Omega - 0.0265 \times P_b + 0.052 \quad \text{Eq. 32}$$

where: P_b = Percent binder by weight.

Macro-Texture Durability

For asphalt mix types, high permeability, high air voids, and thin asphalt coatings on aggregate particles are the primary causes of excessive aging of the asphalt binder. This aging contributes to lack of durability and loss of long-term pavement friction (Kandhal, Foo, and Mallick, 1998). Thus, mix proportioning must optimize the asphalt mix properties.

In the special case of open-graded asphalt mixes, maintaining the long-term durability and pavement friction while ensuring a high porosity/permeability is required. Additives and polymers can be used to prevent moisture damage and excessive aging of the asphalt binder. Specific recommendations for ensuring durable asphalt mixes are presented below.

- Dense, Uniform, and Gap-Graded Mixes—As a consequence of their low void content and thick binder films, these mixes have proven to be durable and resistant to age hardening. Some pavement friction-related considerations are as follows:
 - Make a careful choice of aggregate size, shape, and grading to produce a dense asphalt surface that will meet micro-texture and macro-texture requirements.

- Limit the voids in the asphalt mix to ensure adequate durability. However, if the void content is too low, deformation can occur resulting in a loss of macrotexture.
 - Ensure a thick film of asphalt binder around the coarse aggregate to prevent thin asphalt binder films and excessive aging. However, the binder content must not be excessive to cause bleeding.
 - SMA mixes may require a stiff asphalt binder to ensure durability. This can be achieved by using the harder asphalt binder grades or by adding polymers to the binder.
- Open-Graded Mixes—Maintaining high levels of permeability/porosity is important for maintaining the drainage characteristics of open-graded asphalt mixes. This is achieved by using open-graded aggregates held together by asphalt binder to form a matrix with interconnecting voids through which water can pass. Unfortunately the interconnected voids allow excellent access to air; so aging and embrittlement of the asphalt binder may be exacerbated. To ensure both permeability and durability in the long term, the following is recommended for design:
 - Enhance asphalt mix durability by using softer grade binders and as high a binder content as possible. The binder content must be optimized through testing to ensure adequate permeability.
 - Avoid lean asphalt mixes, as these types of mixes are mostly not durable.
 - Avoid rich asphalt mixes, as these types of mixes are likely to flush/bleed, resulting in patches of binder on the road surface causing low pavement friction and an impermeable surface (poor drainage).
 - The design binder content (optimized through testing) represents the maximum quantity of binder that can be incorporated into the porous asphalt mix without introducing excessive binder drainage causing segregation during mixing, transportation, and placement.
 - Excessive binder content and/or excessive mixing temperature causes binder drainage and mixture segregation during transportation from the mixing plant, leading to inconsistency of the finished surface, with areas either rich or lean in binder content.
 - Temperature controls and maximum target binder contents must be incorporated into the design specification to reduce the occurrence of defective surfaces.
 - If it is necessary to improve bonding characteristics and durability, polymer-modified binders should be used.

Noise Considerations

The two biggest keys to producing low noise asphalt pavements are surface texture and porosity (Newcomb and Scofield, 2004). A relatively flat surface with voids in it (i.e., negative texture) has better acoustical performance than one that has protrusions above the surface (i.e., positive texture).

For pavement–tire noise reduction, smaller maximum aggregate size and negative texture are better (Newcomb and Scofield, 2004). Larger sized surface texture tends to produce greater noise, which is why coarse chip and coarse-graded dense HMA surface mixes can be

noisier than those having a smaller maximum aggregate size. Mixes containing a 0.18- or 0.25-in (5- or 6-mm) maximum aggregate size produce the quietest pavements, compared to reference dense-graded mixes containing a 0.55- or 0.62-in (14- or 16-mm) maximum aggregate size.

Porosity in the surface is a means to achieve even further pavement–tire noise reduction (Newcomb and Scofield, 2004). OGFC combined with a smaller aggregate size is very effective in reducing noise from traffic. Two-layer OGFCs (coarser underlying porous layer and finer porous surface layer) help maintain safety and reduce noise.

In closing, while macro-texture should be kept as low as practical to reduce noise—in the 0.4- to 2.0-in (10- to 50-mm) range—it should not be done at the price of good surface friction (Wayson, 1998).

Concrete Mix Design and Texturing Selection

Concrete surface macro-texture is determined by the type of texturing applied to the surface of the concrete (whether freshly placed or hardened). As with asphalt surface mixes, designers must identify a texturing application that produces a macro-texture (*MTD*) that, when combined with the aggregate *PSV*, satisfies the friction design requirements (Step 1). Extensive recommendations for applying the finishing methods listed in table 26 have been presented in several references, including FHWA *Technical Advisory T 5040.36* (FHWA, 2005).

Macro-Texture Durability

The strength/abrasion properties of the cement mortar/paste largely determine the wearing characteristics of new concrete surfaces. Increasing the cement content (or decreasing the water-cement ratio) and implementing sound construction practices maximizes cement paste/mortar strength and, thus, abrasion resistance. Additionally, the use of air-entrained cement paste/mortar where freezing and thawing is encountered, can relieve pressure in the paste during freezing, thereby reducing the potential for the paste to crack.

Noise Considerations

Tine or groove depth, width, spacing, and orientation are all major factors affecting pavement-tire noise (Hoerner et al., 2003). Transverse tinings with uniformly spaced tines 0.5 in (13 mm) or greater have been found to produce an objectionable tonal quality (tire whine). Randomly varying the transverse tine spacing can reduce the tonal quality problems. Tire noise increases with tine width; research shows mixed data regarding the impact of tine depth on noise.

Skewing of transverse tining has been found to reduce pavement–tire noise (Hoerner et al., 2003). Longitudinal tining, shallow turf drags, and abrading do not exhibit same prominent objectionable tonal spikes observed with uniform transverse tining (Hoerner et al., 2003).

Recommended transverse tining types, with respect to noise, are as follows (Hoerner and Smith, 2002):

- Repeated random, with spacing of 0.4 to 3.0 in (10 to 76 mm), depth of 0.125 in to 0.25 in (3 to 6 mm), width of 0.125 in (3 mm), and skew of 1:6.
- Repeated random, with spacing of 0.4 to 2.0 in (10 to 51 mm), depth of 0.125 in to 0.25 in (3 to 6 mm), width of 0.125 in (3 mm), and skew of 1:6.

Recommended longitudinal tining type, with respect to noise, are as follows (Hoerner and Smith, 2002):

- Uniform, with spacing of 0.75 in (19 mm), depth of 0.125 in to 0.25 in (3 to 6 mm), and width of 0.125 in (3 mm).

Finally, based on Wisconsin's results and Virginia's experience (FHWA, 1996), using transverse and longitudinal tining together (i.e., cross-hatching) produces consistently higher total noise.

Step 4—Development of Construction Specifications

All agencies have standard specifications for construction of pavement surfaces that provide guidance on requirements for aggregates, mixes, handling, placement, compaction, curing, and protection of new surfaces. For some agencies, these specifications do not specifically address friction properties of the wearing surface. To ensure quality friction on new or rehabilitated pavement surfaces, requirements for aggregate properties and test methods presented in this section may be included in project specifications as needed.

Special Provisions

Each project has unique requirements because of the design and construction constraints and special demands. Items such as aggregate blending, noise mitigation, and QA should be clarified in the special provisions of the construction documents and specifications.

Blending

Frequently, aggregates from two or more sources must be blended to meet the specification limits. Several studies (Mullen et al., 1974; Underwood, 1971; Liang, 2003) have reported that the blended aggregate properties tend to be the same as the weighted average of the properties of the individual aggregates. Thus, the goal of blending aggregate is to set the percentages of each aggregate used such that the final blend has properties that lies within the specification limits of the tests to be performed.

Quality Assurance

Among other things, a QA program often stipulates the frequency of testing aggregate sources. It is strongly suggested that an aggregate source be tested extensively whenever substantially new aggregate deposits are to be used for pavement surfacing. The extent and frequency can be reduced as the agency becomes more familiar with the aggregate source and there is a history of performance for aggregates from the given source (Folliard and Smith, 2003).

Construction Issues

Construction deficiencies and poor construction practices can contribute to inadequate friction. Construction issues involve control of aggregate and mix quality during production, handling, stockpiling, mixing, placing, and finishing. Friction restoration treatments in particular, such as chip seals, slurry seals, micro-surfacing, and proprietary surfaces, are susceptible to providing less than expected friction, if poor construction practices are employed.

Step 5—Formulation of Design Strategies

Both monetary and non-monetary factors are considered in selecting preferred pavement design strategy the various feasible alternatives. The main inputs required are (a) estimates of costs, (b) estimates of benefits (if the benefit cost option is selected, not that benefit cost analysis is required only if there is a significant difference in benefits between alternatives, and (c) non-monetary factors.

Important cost elements related to the inclusion of surface friction in the design strategy are:

- Agency costs.
 - Additional design and engineering costs.
 - Aggregate materials with required frictional properties.
 - Additives, including polymers, to improve surface properties and performance.
 - Frequency/duration of restoration activities.
 - Design strategies involving frequent M&R are typically more costly overall because of the effects of highway user delay costs, traffic control, and so on.
 - Timing of M&R can significantly escalate costs if M&R to restore surface friction does not coincide with M&R to restore structural capacity.
- User costs
 - Travel delays (time/delay) for friction restoration impact life cycle cost.
 - Friction can adversely influence pavement–tire factors such as tire wear, rolling resistance, and fuel consumption.
 - Safety associated factors that impact crash costs.
 - Frequency of crashes.
 - Value of crashes.

Benefits from ensuring adequate levels of friction throughout the pavement life are quantified through:

- Improved highway safety (i.e., reduction in crash costs).
 - Value of lives saved.
 - Value of injuries avoided (medical, loss income, psychological damage).
 - Savings in pain and suffering of crash victims and their families due to a reduction in crashes.
 - Reductions in property damage due to reduction in crashes.

Non-monetary factors can be included in the decision matrix and addressed through (a) agency policies and criteria on these factors and (b) appropriate weights to these factors to reflect the importance assigned to them by the agency. The non-monetary design considerations include (AASHTO, 1993):

- Service life.
- Duration of construction.
- Traffic control problems.
- Reliability, constructability, and maintainability of design.

Non-monetary considerations associated with pavement friction include:

- Pavement–tire noise.
- Splash and spray.
- Fuel consumption/rolling resistance.
- Tire wear.
- Reflectance and glare.

This page intentionally left blank.

CHAPTER 7. CONCLUSIONS AND RECOMMENDATIONS

While the main focus of highway agencies more than a generation ago was building an expanded highway system, the priorities have changed such that revamping existing roads and making them safer and less congested, now tops the priority list.

With its strong link to safety, pavement friction is a tremendously important facet of highway transportation. However, achieving and maintaining adequate pavement friction can be very difficult to accomplish by agencies responsible for making roads safer. Though there are many reasons for this difficulty, three of the more apparent ones are: (a) the complexity of the pavement–tire friction interface, (b) controversy concerning the agency’s level of responsibility for ensuring user safety, and (c) uncertainty regarding the costs and benefits of a proactive and effective pavement friction program.

This trend has been reversing gradually, motivated by the staggering levels of fatalities, injuries, and damage due to crashes. This has led to the development of improved pavement friction management, design, and maintenance methods, all of which are important for enhancing highway safety. Although it is impossible for an agency to correct all pavement deficiencies immediately, it is critical for agencies to implement a program that identifies deficiencies, warns the public about potential hazards, and uses reasonable care to correct hazards.

The concepts and mechanisms behind pavement friction are quite involved and not easily understood. Moreover, because there are many factors that affect friction, it is more of a process than an inherent characteristic of the pavement. Thus, while highway engineers can control some factors (e.g., surface texture, speed), conditions and circumstances will arise that may put adequate friction beyond reach.

CONCLUSIONS

This study examined both past and on-going research and the current state-of-the-practice regarding pavement friction. The principles and methodologies of every aspect of friction were investigated in order to develop practical policy and how-to guidance for SHAs. The guidance, which is provided in a stand-alone Guide for Pavement Friction, covers the importance of pavement friction in highway safety; the fundamental concepts of friction; how friction is measured, reported, and managed in the field; and how friction is incorporated in design via the selection of aggregates and surface textures.

This report provided most of the background and supporting information used in developing the new Guide. It discussed the efforts to gather and review important information on friction and related matters, and presented the governing ideas and methods for ensuring adequate friction.

Major conclusions of the study are summarized as follows:

- **Laboratory Testing**—Several tests are available for assessing aggregates' potential to provide adequate initial and long-term micro-texture. The tests can be categorized according to the characterization of mineralogical/ petrographical properties, physical and geometric properties, mechanical properties, and durability properties. Testing protocol and associated performance criteria vary from agency to agency, primarily according to the types of aggregates available and the conditions (traffic, climate, etc.) in which they're used.
- **Field Testing**—Several tests are available for measuring pavement friction and texture. For friction, there are over a dozen commercially produced devices that can operate at fixed or variable slip, at speeds up to 100 mi/hr (161 km/hr), and under variable test tire conditions, such as load, size, tread design, inflation pressure, and construction. Micro-, macro-, or mega-texture can be measured using a variety of laser devices (including CTM), volumetric techniques (SPM), water drainage rates (OFM), and sliding rubber pad apparatus (BPT, DFT).

The literature review and interviews conducted as part of this study show a majority of agencies test their highway networks frequently for friction. The locked-wheel skid trailer test method (ASTM E 274) has been and continues to be the most common method for testing friction. The ribbed tire (ASTM E 501) is the main tire used with the locked-wheel testers, however, there is an increasing use of the smooth tire (ASTM E 524), as it has been shown that the ribbed tire does not see macro-texture and, thus, can miss very slippery conditions. While most agencies do not measure pavement surface texture on a routine basis for friction management or design purposes, they generally recognize the benefits of texture testing and several agencies are investigating the applications.

- **Surface Mixes and Texturing Techniques**—Pavement macro-texture is primarily determined by the size and gradation of the aggregate in asphalt mixes (and exposed concrete mixes) and by the type of texturing applied to the surface of concrete mixes. Large-sized open-, gap-, or uniformly graded mixes generally provide the highest levels of texture depth, whereas small-sized dense-graded mixes provide the lowest levels. Although greater texture depth improves friction at higher speeds and reduces splash/spray, it can produce increased noise—particularly if the texture is positive—and greater tire wear.

For concrete surfaces, burlap, broom, and most turf drag finishes provide the lowest levels of macro-texture, whereas exposed aggregate and porous concrete surfaces (which are rarely used) provide the highest levels. While tining, grinding, and grooving all yield significant levels of macro-texture, the orientation, spacing, and width of the grooves can impact friction and other pavement–tire interactions. For instance, transverse grooves provide drainage paths for water, thereby reducing hydroplaning potential. In addition, random, skewed grooves result in less noise than uniform, perpendicular grooves. Although longitudinal grooves provide improved resistance to lateral skidding and reduced noise, they yield less stopping friction and greater splash/spray than transverse grooves.

- Friction Management—While most SHAs have some components of a friction management program in-place, only a few (e.g., Texas, Maryland, Virginia) have a comprehensive program that utilizes all of the basic components. Such agencies have invested significant resources into developing and improving their friction management policies to tackle highway safety issues.
- Friction Design Policy—Current friction design policies vary widely, with some states having only basic control measures and others having full-scale testing programs and performance databases. The scope and level of detail of friction design policies are largely determined by the availability of good quality aggregates and the general perception of whether wet-weather safety is an issue within the state.
- Friction Investigatory and Intervention Levels—Most agencies do not clearly define minimum friction demand requirements for various site categories.

RECOMMENDATIONS

Although an enormous amount of information on pavement friction, texture, and related topics was gathered and analyzed in this study, there still remain many issues to be resolved concerning how to design, test, and manage pavements for friction. Provided below is a list of the most pressing issues and recommendations for addressing them in the future.

- Laboratory Testing—While several tests have been identified as being good indicators of friction performance, there is room for improvement in the predictive capabilities of the tests. Such improvements could focus on the reduction of variability in test results, better simulation of in-service conditions, and closer controls in trying to relate aggregate type/source to field performance, via test properties. Additionally, research into new test methods, for both aggregates and mixtures, should continue, along with the development of databases to better link both design micro-texture and macro-texture with friction (and other characteristics, such as noise and splash/spray) in the field.
- Field Testing—The locked-wheel friction test method (ASTM E 274) has been tried and tested over the years, and has proven to be reliable and accurate. It is strongly recommended that agencies consider use of the smooth tire (ASTM E 524) with locked-wheel testers. Pavement surface texture, on the other hand, is measured using various test equipment and associated protocols. The standard indices are *MTD* for the SPM volumetric method and *MPD* for laser-based measurements. The *MTD* and *MPD* are well correlated. The use of a universal friction/texture measuring index, such as the IFI, is one method of standardizing friction/texture test results.

- **Surface Mixes and Texturings**—Several on-going research studies and programs (NCHRP Project 10-67, NCAT, FHWA Concrete Pavement Surface Characteristics, and the Institute for Safe Quiet and Durable Highways [ISQDH]) are examining the issue of macro-texture, as provided by surface mixtures and texturing applications. Models developed to estimate texture depth based on mixture gradations and volumetrics should be evaluated and, as appropriate, incorporated into future Guide documents. Similarly, efforts to model the texture depth of different types of texturing on concrete pavement should be monitored. The effects of macro-texture on noise and other pavement–tire interaction issues should be a key part of the monitoring process.
- **Friction Design Policy**—Although considerable guidance on friction design was developed and presented in the Guide, pavement designers could benefit from a comprehensive, systematic procedure for screening aggregates for use.
- **Friction Management Policy**—Although very few agencies have a comprehensive friction management program in-place, this situation can be reversed by adopting, as needed, the guidance on friction management presented in the Guide. Also, there is a vast amount of knowledge available in published literature worldwide that can be used along with local experience to improve agency friction management policies. The development of such policies will help agencies reduce risk of tort litigation.

REFERENCES

- Al-Qadi, I.L., G.W. Flintsch, D.S. Roosevelt, R. Decker, J.C. Wambold, and W.A. Nixon. 2002. "Feasibility of Using Friction Indicators to Improve Winter Maintenance Operations and Mobility," NCHRP Web Document 53, National Cooperative Highway Research Program (NCHRP), Washington, D.C.
- American Association of State Highway and Transportation Officials (AASHTO). 1976. *Guidelines for Skid-Resistant Pavement Design*, Task Force for Pavement Design, AASHTO, Washington, D.C.
- American Association of State Highway and Transportation Officials (AASHTO). 1993. "Guide for Design of Pavement Structures," Joint Task Force on Pavements, AASHTO, Washington, D.C.
- American Association of State Highway and Transportation Officials (AASHTO). 2001. "A Policy on Geometric Design of Highways and Streets," *AASHTO Green Book*, AASHTO, Washington, D.C.
- Anderson, D.A., R.S. Huebner, J.R. Reed, J.C. Warner, and J.J. Henry. 1998. *Improved Surface Drainage of Pavements*, NCHRP Web Document 16, National Cooperative Highway Research Foundation (NCHRP), Washington, D.C.
- Andresen A. and J.C. Wambold. 1999. "Friction Fundamentals, Concepts and Methodology," TP 13837E, Transportation Development Centre, Canada.
- Austrroads. 2005. "Guidelines for the Management of Road Surface Skid Resistance," Austrroads Publication No. AP-G83/05, Austrroads Incorporated, Sydney, Australia.
- Bray, J. 2002. "The Role of Crash Surveillance and Program Evaluation: NYSDOT's Skid Accident Reduction Program (SKARP)," Presented at 28th International Forum on Traffic Records and Highway information Systems, Orlando, Florida.
- Cairney, P. 1997. "Skid Resistance and Crashes – A Review of the Literature," Research Report No. 311, ARRB Transport Research Ltd., Vermont South Victoria, Australia.
- Chelliah, T., P. Stephanos, M.G. Shah, and T. Smith. 2003. "Developing a Design Policy to Improve Pavement Surface Characteristics," Paper presented at 82nd Annual Meeting of the Transportation Research Board, Washington, D.C.
- Craus, J., M. Livneh, and I. Ishai. 1991. "Effect of Pavement and Shoulder Condition on Highway Accidents," *Transportation Research Record 1318*, Transportation Research Board, Washington, D.C.
- Crouch, L.K., G. Shirley, G. Head, and W.A. Goodwin. 1996. "Aggregate Polishing Resistance Pre-Evaluation," *Transportation Research Record 1530*, Transportation Research Board (TRB), Washington, D.C.

Crouch, L.K. and T.R. Dunn. 2005. "Identification of Aggregates for Tennessee Bituminous Surface Courses," Phase IV Final Report, Project No. TNSPR-RES 1149, Tennessee Department of Transportation, Nashville, Tennessee.

Dahir, S.H. and J.J. Henry. 1978. Alternatives for the Optimization of Aggregate and Pavement Properties Related to Friction and Wear Resistance, Report No. FHWA-RD-78-209, Federal Highway Administration (FHWA), Washington, D.C.

Davis, R.M. 2001. Comparison of Surface Characteristics of Hot-Mix Asphalt Pavement Surfaces at the Virginia Smart Road, Thesis submitted to the faculty of Virginia Polytechnic Institute and State University, Blacksburg, Virginia.

Farber, E., M.S. Janoff, S. Cristinzio, J.G. Blubaugh, W. Reisener, and W. Dunning. 2004. "Determining Pavement Skid-Resistance Requirements at Intersections and Braking Sites," *NCHRP Report No. 154*, National Cooperative Highway Research Program (NCHRP), Washington, D.C.

Federal Highway Administration (FHWA). 1980. "Skid Accident Reduction Program," *Technical Advisory T 5040.17*, U.S. Department of Transportation, FHWA, Washington, D.C.

Federal Highway Administration (FHWA). 1996. "PCC Surface Texture Technical Working Group Findings," FHWA, Washington, D.C.

Federal Highway Administration (FHWA). 2005. "Surface Texture for Asphalt and Concrete Pavements," *Technical Advisory T 5040.36*, U.S. Department of Transportation, Federal Highway Administration, Washington, D.C.

Flintsch, G.W., I.L. Al-Qadi, R. Davis, and K.K. McGhee. 2002. "Effect of HMA Properties on Pavement Surface Characteristics," *Proceedings of the Pavement Evaluation 2002 Conference*, Roanoke, Virginia.

Flintsch G.W., E. De Leon, K.K. McGhee, and I.L. Al-Qadi. 2003. "Pavement Surface Macro-texture Measurement and Application," Transportation Research Board (TRB), Washington, D.C.

Folliard, K.J. and K.D. Smith. 2003. "Aggregate Tests for Portland Cement Concrete Pavements: Review and Recommendations," September edition (No. 281) of *NCHRP Research Results Digest*, National Cooperative Highway Research Program (NCHRP), Washington, D.C.

Gandhi, P.M., B. Colucci, and S.P. Gandhi. 1991. "Polishing of Aggregates and Wet-Weather Accident Rates for Flexible Pavements," *Transportation Research Record 1300*, Transportation Research Board (TRB), Washington, D.C.

- Giles, C.G., B.E. Sabey, and K.H.F. Cardew. 1962. "Development and Performance of the Portable Skid Resistance Tester," ASTM Special Technical Publication No. 326, American Society for Testing and Materials (ASTM), Philadelphia, Pennsylvania.
- Gillespie, T.D. 1992. *Fundamentals of Vehicle Dynamics*, Society of Automotive Engineers (SAE), Warrendale, Pennsylvania.
- Glennon, J.C. 1996. "Roadway Defects and Tort Liability," Lawyers & Judges Publishing Company, Inc., Tucson, Arizona.
- Gothie, M. 1996. "Relationship Between Surface Characteristics and Accidents," *Proceedings of 3rd International Symposium on Pavement Surface Characteristics*, Christchurch, New Zealand.
- Gransberg, D. and D.M.B. James. 2005. "Chip Seal Best Practices," *NCHRP Synthesis 342*, National Cooperative Highway Research Program (NCHRP), Washington, D.C.
- Hanson, D.I. and B.D. Prowell. 2004. "Evaluation of Circular Texture Meter for Measuring Surface Texture of Pavements," NCAT Report No. 04-05, National Center for Asphalt Technology (NCAT), Auburn, Alabama.
- Harwood, D.W., et al. 1987. "Wet Weather Exposure Measures," Report No. FHWA/RD-87/105, Federal Highway Administration (FHWA), Washington, D.C.
- Hayes, G.G., D.L. Ivey, and B.M. Gallaway. 1983. "Hydroplaning, Hydrodynamic Drag, and Vehicle Stability," *Special Technical Publication 793*, American Society for Testing and Materials (ASTM), Philadelphia, Pennsylvania.
- Henry, J.J. 1983. "Comparison of Friction Performance of a Passenger Tire and the ASTM Standard Test Tires," *ASTM STP 793*, American Society for Testing and Materials (ASTM), Philadelphia, Pennsylvania.
- Henry, J.J. 2000. "Evaluation of Pavement Friction Characteristics," *NCHRP Synthesis 291*, National Cooperative Highway Research Program (NCHRP), Washington, D.C.
- Highways Agency (HA). 2004. *Design Manual for Roads and Bridges*, Volume 7, HD 28, "Skid Resistance," Department for Transport, London, United Kingdom.
- Highway Innovative Technology Evaluation Center (HITEC). 2003. Evaluations—Italgrip System, Civil Engineering Research Foundation (CERF) HITEC website (www.cerf.org/hitec/evals.htm), Washington D.C.
- Hoerner, T.E., K.D. Smith, R.M. Larson, and M.E. Swanlund. 2003. "Current Practice of PCC Pavement Texturing," Paper presented at 82nd Annual Meeting of the Transportation Research Board, Washington, D.C.

Hoerner, T.E. and K.D. Smith. 2002. *High Performance Concrete Pavement: Pavement Texturing and Tire-Pavement Noise*, FHWA Report No. FHWA-IF-02-020, Federal Highway Administration, Washington, D.C.

Horne, W.B. and F. Buhlmann. 1983. "A Method for Rating the Skid Resistance and Micro/Macro-texture Characteristics of Wet Pavements," ASTM International STP No. 793, W. E Meyers and J. D. Walter, Editors American Society for testing and materials, Philadelphia, Pennsylvania.

Iowa Department of Transportation (Iowa DOT). 2005. "Toolbox of Highway Safety Strategies," Iowa DOT Safety Management System website (www.IowaSMS.org).

Jayawickrama, P.W., R. Prasanna, and S.P. Senadheera. 1996. "Survey of State Practices to Control Skid Resistance on Hot-Mix Asphalt Concrete Pavements," *Transportation Research Record 1536*, Transportation Research Board (TRB), Washington, D.C.

Kamel, N. and T. Gartshore. 1982. "Ontario's Wet Pavement Accident Reduction Program," ASTM Special Technical Publication 763, American Society of Testing and Materials, (ASTM), Philadelphia, Pennsylvania.

Kandhal, P.S., F. Parker Jr., and R.B. Mallick. 1997. *Aggregate Tests for Hot Mix Asphalt: State of the Practice*, NCAT Report No. 97-6, National Center for Asphalt Technology (NCAT), Auburn, Alabama.

Kandhal, P.S. and F. Parker Jr. 1998. 1997. *Aggregate Tests Related to Asphalt Concrete Performance in Pavements*, NCHRP Report 405, National Cooperative Highway Research Program (NCHRP), Washington, D.C.

Kandhal, P.S., K.Y. Foo, and R.B. Mallick. 1998. "A Critical Review of VMA Requirements in SuperPave," NCAT Report 98-01, National Center for Asphalt Technology (NCAT), Auburn, Alabama.

Kuemmel, D.A., J.R. Jaeckel, and A. Satanovsky. 2000. *Investigative Study of the Italgrip System: Noise Analysis*, Report No. WI/SPR-02-00Wisconsin Department of Transportation, Madison, Wisconsin.

Kulakowski, B.T., J.C. Wambold, C.E. Antle, C. Lin, and J.M. Mason. 1990. "Development of a Methodology to Identify and Correct Slippery Pavements," FHWA-PA90-002+88-06, The Pennsylvania Transportation Institute, State College, Pennsylvania.

Kuttesch, J. S. 2004. "Quantifying the Relationship Between Skid Resistance and Wet Weather Accidents for Virginia Data," M.S. Thesis, Department of Civil Engineering, Virginia Polytechnic Institute and State University, Blacksburg, Virginia.

Larson, R.M. 1999. "Consideration of Tire/Pavement Friction/Texture Effects on Pavement Structural Design and Materials Mix Design," Federal Highway Administration (FHWA), Office of Pavement Technology, Washington, D.C.

- Liang, R.Y. 2003. "Blending Proportions of High Skid and Low Skid Aggregate," Final Report prepared for Ohio Department of Transportation (ODOT), Columbus, Ohio.
- Liang, R.Y. and L.L. Chyi. 2000. "Polishing And Friction Characteristics Of Aggregates Produced in Ohio," Report No. FHWA/OH-2000/001, Ohio Department of Transportation, Columbus, Ohio.
- Mahone, D.C. and S.N. Runkle. 1972. "Pavement Friction Needs," *Highway Research Record 396*, Highway Research Board, Washington D.C.
- McCullough, B.V. and K.D. Hankins. 1966. "Skid Resistance Guidelines for Surface Improvements on Texas Highways," In *Transportation Research Record: Journal of the Transportation Research Board (TRB)*, No. 131, TRB, Washington, D.C.
- McDaniel, R.S. and B.J. Coree. 2003. "Identification of Laboratory Techniques to Optimize SuperPave HMA Surface Friction Characteristic," Phase I Final Report, SQDH 2003-6, HL 2003-19, Institute for Safe, Quiet, and Durable Highways (ISQDH), Purdue University.
- McGhee, K.K. and G.W. Flintsch. 2003. "High Speed Texture Measurement of Pavements," Final Report, Report No. VTRC 03-R9, Virginia Transportation Research Council (VTRC), Charlottesville, Virginia.
- McLean, J. 1995. "The Relationship Between Pavement Condition and Road Safety," Paper presented at the Load-Pavement Interaction Workshop, Newcastle.
- McNeal, A.F. 1995. "A Summary of the Illinois Skid-Accident Reduction Program 1989-1994," Physical Research Report No. 119, Bureau of Materials and Physical Research, Illinois Department of Transportation, Springfield, Illinois.
- McNerney, M.T., B.J. Landsberger, T. Turen, and A. Pandelides. 2000. "Comparative Field Measurements of Tire/Pavement Noise of Selected Texas Pavements," Report No. FHWA/TX-7-2957-2, Texas Department of Transportation, Austin, Texas.
- Meegoda, J.N., C.H. Hettiarachchi, G.M. Rowe, N. Bandara, and M.J. Sharrock. 2002. Correlation of Surface Texture, Segregation, and Measurement of Air Voids, Final Report prepared for New Jersey Department of Transportation, Trenton, New Jersey.
- Meyer, W.E. 1982. *Synthesis of Frictional Requirements Research*, Report No. FHWA/RD-81/159, Federal Highway Administration (FHWA), Washington, D.C.
- Meininger, R.C. 1994. "Degradation Resistance, Strength, Toughness, and Related Properties," ASTM STP 169C, ASTM, West Conshohocken, Pennsylvania.
- Miller, M.M. and H.D. Johnson. 1973. "Effects of Resistance to Skidding on Accidents: Surface Dressing on an Elevated Section of the M4 Motorway," Report No. LR 542, Transport and Road Research Laboratory, Berkshire, United Kingdom.

Mockensturm, E.M., B.T. Kulakowski, and N.M. Hawk. 2002. "Measurement and Evaluation of Roadside Noise Generated by Transit Buses," Final Report, The Institute for Safe, Quiet, and Durable Highways (ISQDH), Purdue University.

Mullen, W.G., S.H. Dahir, and M. El Madani. 1974. "Laboratory Evaluation of Aggregates: Aggregate Blends and Bituminous Mixes for Polish Resistance," Transportation Research Record 523, *Transportation Research Board*, Washington, D.C.

National Highway Traffic Safety Administration (NHTSA). 1998. "Report to Congress: Update on the Status of Splash and Spray Suppression Technology for Large Trucks," NHTSA, Washington, D.C.

National Highway Traffic Safety Administration (NHTSA). 2004. "Traffic Safety Facts 2003 – A Compilation of Motor Vehicle Crash Data from the Fatality Analysis Reporting System and the General Estimates System," NHTSA website (<http://www-nrd.nhtsa.dot.gov>).

Newcomb, D. and L. Scofield. 2004. "Quiet Pavements Raise the Roof in Europe: Scanning Tour Reveals European Practice for Noise Mitigation," September/October edition of *Hot Mix Asphalt Technology*.

Noyce, D.A., H.U. Bahia, J.M. Yambo, and G. Kim. 2005. Incorporating Road Safety into Pavement Management: Maximizing Asphalt Pavement Surface Friction for Road Safety Improvements," Draft Literature Review and State Surveys, Midwest Regional University Transportation Center (UMTRI), Madison, Wisconsin.

Ong, G.P. and T.F. Fwa. 2006. "Transverse Pavement Grooving Against Hydroplaning I: Simulation Model," *Journal of Transportation Engineering*, Volume 132, Number 6, American Society of Civil Engineers (ASCE), Reston, Virginia.

Organization for Economic Cooperation and Development (OECD). 1984. "Road Surface Characteristics – Their Interaction and their Optimisation," OECD Scientific Expert Group, Road Transport Research, Paris, France.

Page, B.G. and L.F. Butas. 1986. Evaluation of Friction Requirements for California State Highways in Terms of Highway Geometrics, Report No. FHWA/CA/TL 86/01, Federal Highway Administration, Washington, D.C.

Permanent International Association of Road Congresses (PIARC). 1987. "Report of the Committee on Surface Characteristics," *Proceedings of the 18th World Road Congress*, Brussels, Belgium.

Permanent International Association of Road Congresses (PIARC). 1995. *International PIARC Experiment to Compare and Harmonize Texture and Skid Resistance Measurements*, Report No. AIPCR-01.040.T, PIARC, Brussels, Belgium.

- Prowell, B.D., J. Zhang, and E.R. Brown. 2005. "Aggregate Properties and the Performance of SuperPave-Designed Hot Mix Asphalt," *NCHRP Report 539*, National Cooperative Highway Research Program (NCHRP), Washington, D.C.
- Radlinski, R.W. and S.F. Williams. 1985. "Stopping Capability of Air-Braked Vehicles," Report No. DOT-HS-806-738, NHTSA Heavy Duty Vehicle Brake Research Program, National Highway Traffic Safety Administration (NHTSA), Washington, D.C.
- Rado, Z. 1994. "Analysis of Texture Models," PTI Report No. 9510, Pennsylvania Transportation Institute (PTI), Penn State University, State College, Pennsylvania.
- Radt, H.S. and W.F. Milliken. 1960. *Motions of Skidding Automobiles*, Paper No. 600133 (205A), Society of Automotive Engineers (SAE), Warrendale, Pennsylvania.
- Rao, S., H.T. Yu, L. Khazanovich, M.I. Darter, and J.W. Mack. 1999. "Longevity of Diamond Ground Concrete Pavements," Paper presented at 78th Annual Meeting of the Transportation Research Board, Washington, D.C.
- Rasoulia, M. 2004. Notes from February 19, 2004 teleconference with Mr. Masood Rasoulia, Louisiana Transportation Research Center.
- Richardson, J.T.G. 1999. "Stone Mastic Asphalt in the U.K.," Society of Chemical Industry (SCI) Lecture Papers Series, London, United Kingdom.
- Rizenbergs, R.L., J.L. Burchett, and C.T. Napier. 1972. "Skid Resistance of Pavements," Report No. KYHPR-64-24, Part II, Kentucky Department of Highways, Lexington, Kentucky.
- Roberts, F.L., P.S. Kandhal, E.R. Brown, D.Y. Lee, and T.W. Kennedy. 1996. "Hot Mix Asphalt Materials: Mixture Design, and Construction," National Asphalt Pavement Association (NAPA) Education Foundation, Lanham, Maryland.
- Rowdan, L. 2004. Notes from February 19, 2004 teleconference with Ms. LaDonna Rowdan, Illinois Department of Transportation.
- Saito, K., T. Horiguchi, A. Kasahara, H. Abe, and J.J. Henry. 1996. "Development of Portable Tester for Measuring Skid Resistance and its Speed Dependency on Pavement Surfaces," *Transportation Research Record No. 1536*, Transportation Research Board, Washington, D.C.
- Sandburg, U. 1998. "Influence of Road Surface Texture on Traffic Characteristics Related to Environment, Economy, and Safety: A State-of-the-Art Study Regarding Measures and Measuring Methods," VTI Report 53A-1997, Swedish National Road Administration, Borlange, Sweden.
- Sandburg, U. and J.A. Ejsmont. 2002. *Tyre/Road Noise Reference Book*, ISBN 91-631-2610-9, Informex, Kisa, Sweden.

- Schulze, K.H., A. Gerbaldi, and J. Chavet. 1976. "Skidding Accidents, Friction Numbers, and the Legal Aspects Involved," In *Transportation Research Record: Journal of the Transportation Research Board*, No. 623, TRB, Washington, D.C.
- Senior, S.A. and C.A. Rogers. 1991. "Laboratory Tests for Predicting Coarse Aggregate Performance in Ontario," *Transportation Research Record* 1301, Transportation Research Board, Washington, D.C.
- Skerritt, W.H. 2004. "Notes from February 19, 2004 teleconference with Mr. Bill Skerritt of the New York Department of Transportation, Engineering Geology section of the Materials Bureau."
- Stampley, B. 2004. "Notes from February 13, 2004 teleconference with Mr. Bryan Stampley, Pavement Management Engineer with Texas Department of Transportation."
- Stroup-Gardiner, M. and E.R. Brown. 2000. "Segregation in Hot-Mix Asphalt Pavements," *NCHRP Report 441*, National Cooperative Highway Research Program (NCHRP), Washington, D.C.
- Sullivan, B.W. 2005. "Development of a Fundamental Skid Resistance Asphalt Mix Design Procedure," Pavement Management Service, Sydney, Australia.
- Transit New Zealand. 2002. "Specifications for Skid Resistance Investigation and Treatment Selection," TNZ T10-2002, Transit New Zealand, Christchurch, New Zealand.
- Transit New Zealand. 2002. "Notes to the Specifications for Skid Resistance Investigation and Treatment Selection," TNZ T10 Notes-2002, Transit New Zealand, Christchurch, New Zealand.
- Texas Department of Transportation (TXDOT). 2004. "Chapter 5—Wet Weather Accident Reduction Program," *Pavement Design Manual*, TXDOT, Austin, Texas.
- Underwood, J.P. 1971. "Aggregate Polishing Characteristics: The British Wheel Test and the Insoluble Residue Test," Research Report No. 126-2, Texas Department of Transportation, Austin, Texas.
- Victoria Roads (VicRoads) and Roads and Traffic Authority (RTA) of New South Wales. 1996. "Guide for the Measurement and Interpretation of Skid Resistance Using SCRIM," VicRoads, Victoria, Australia and RTA of New South Wales, Australia.
- Viner, H., R. Sinhal, and T. Parry. 2004. "Review of UK Skid Resistance Policy," Paper prepared for 5th International Symposium on Pavement Surface Characteristics---Road and Airports, Toronto, Ontario, Canada.
- Wade, M., R. DeSombre, and D. Peshkin. 2001. "High Volume/High Speed Asphalt Roadway Preventive Maintenance Surface Treatments," Final Report, South Dakota Department of Transportation, Pierre, South Dakota.

Wallman, C.G. and H. Astrom. 2001. "Friction Measurement Methods and the Correlation Between Road Friction and Traffic Safety," Swedish National Road and Transport Research Institute, VTI Meddelande 911A, Linkoping, Sweden.

Wambold, J.C., J.J. Henry, and R.R. Blackburn. 1984. *Pavement Surface Texture: Significance and Measurement*, Report No. FHWA/RD-84/092, Federal Highway Administration (FHWA), Washington, D.C.

Washington Asphalt Pavement Association (WAPA). 2004. "Asphalt Pavement Guide," on-line website www.asphaltwa.com.

Washington Department of Transportation (WSDOT). 2005. "Factors Affecting HMA Permeability," Tech Notes, WSDOT Materials Laboratory, Olympia, Washington.

Wayson, R.L. 1998. "Relationship Between Pavement Surface Texture and Highway Traffic Noise," *NCHRP Synthesis 268*, National Cooperative Highway Research Program (NCHRP), Washington, D.C.

World Health Organization (WHO). 2004. "World Report on Road Traffic Injury Prevention," WHO, Geneva, Switzerland.

Wu, Y., F. Parker, and K. Kandhal. 1998. *Aggregate Toughness/Abrasion Resistance and Durability/Soundness Tests Related to Asphalt Concrete Performance in Pavements*, NCAT Report 98-04, National Center for Asphalt Technology (NCAT), Auburn, Alabama.

Xiao, J., B.T. Kulakowski, and M. El-Gindy. 2000. "Prediction of Risk of Wet-Pavement Accidents: Fuzzy Logic Model," *Transportation Research Record 1717*, Transportation Research Board, Washington, D.C.

Yaron, R. and S. Nesichi. 2005. "Alleviating the Skid Resistance Problem: The Israeli Experience," Paper presented at *First International Conference on Surface Friction: Roads and Runways*, Christchurch, New Zealand.

This page intentionally left blank.

APPENDIX A BIBLIOGRAPHY

Abe, H., J.J. Henry, A. Tamai, and J. Wambold, "Measure of Pavement Macrotexture using the CTMeter," 01-3519, Transportation Research Board (TRB), Washington, D.C. (2000).

Agent, K.R., N. Stamatiadis, and S. Jones, "Development of Accident Reduction Factors," Research Report KTC-96-13, University of Kentucky, Kentucky Transportation Cabinet, Lexington, Kentucky (1996).

Airport Surface Friction Tester (ASFT), "Friction Testing 1944-1997," ASFT website www.asft.se/history.html (2003).

Agrawal, S.K., W.E. Meyer, and J.J. Henry, "Measurement of Hydroplaning Potential," Report No. FHWA-PA-72-6, Pennsylvania Department of Transportation, Harrisburg, Pennsylvania (1977).

Al-Qadi, I.L., G.W. Flintsch, D.S. Roosevelt, R. Decker, J.C. Wambold, and W.A. Nixon, "Feasibility of Using Friction Indicators to Improve Winter Maintenance Operations and Mobility," NCHRP Web Document 53, National Cooperative Highway Research Program (NCHRP), Washington, D.C. (2002).

American Association of State Highway and Transportation Officials (AASHTO), "Guidelines for Skid Resistant Pavement Design," Task Force for Pavement Design, AASHTO, Washington, D.C. (1976).

AASHTO, "Guide for Design of Pavement Structures," Joint Task Force on Pavements, AASHTO, Washington, D.C. (1993).

AASHTO, "A Policy on Geometric Design of Highways and Streets," *AASHTO Green Book*, AASHTO, Washington, D.C. (2001).

AASHTO, "Standard Method of Test for Uncompacted Void Content of Coarse Aggregate (as Influenced by Particle Shape, Surface Texture, and Grading)," AASHTO T 326-05, AASHTO, Washington, D.C. (2005).

AASHTO, "Standard Method of Test for Soundness of Aggregate by Use of Sodium Sulfate or Magnesium Sulfate," AASHTO T 104-99, AASHTO, Washington, D.C. (2003).

AASHTO, "Standard Method of Test for Sieve Analysis of Fine and Coarse Aggregates," AASHTO T 27-99, AASHTO, Washington, D.C. (2003).

AASHTO, "Standard Method of Test for Soundness of Aggregates by Freezing and Thawing," AASHTO T 103-91, AASHTO, Washington, D.C. (2003).

AASHTO, "Standard Method of Test for Aggregate Durability Index," AASHTO T 210-01, AASHTO, Washington, D.C. (2003).

AASHTO, "Standard Method of Test for Surface Frictional Properties Using the British Pendulum Tester," AASHTO T 278-90, AASHTO, Washington, D.C. (2003).

AASHTO, "Standard Method of Accelerated Polishing of Aggregates Using the British Wheel," AASHTO T 279-96, AASHTO, Washington, D.C. (2003).

AASHTO, "Standard Method of Test for Resistance to Degradation of Small-Size Coarse Aggregate by Abrasion and Impact in the Los Angeles Machine," AASHTO T 96-02, AASHTO, Washington, D.C. (2003).

AASHTO, "Standard Method of Test for Uncompacted Void Content of Fine Aggregate," AASHTO T 304-96, AASHTO, Washington, D.C. (2003).

American Concrete Institute (ACI), "Texturing Concrete Pavements," *ACI Materials Journal*, ACI, Farmington Hills, Michigan (1988).

American Concrete Pavement Association (ACPA), "Concrete Pavement Surface Textures," *Special Report No. SR902P*, ACPA, Skokie, Illinois (2000).

ACPA, "What's All the Noise About?" Volume 39, No. 1, ACPA, Skokie, Illinois (2003).

ACPA, "Concrete Pavement Research & Technology Update," Number 4.09, ACPA, Skokie, Illinois (2003).

ACPA, "Database of State DOT Concrete Paving Practices-Texture Methods," ACPA website (2003).

American Society for Testing and Materials (ASTM), "Standard Test Methods for Measurement of Skid Resistance on Paved Surfaces Using a Passenger Vehicle Diagonal Braking Technique," ASTM E 503-88, Volume 04.03, ASTM, Philadelphia, Pennsylvania (1989).

ASTM, "Standard Practice for Calculating International Friction Index of a Pavement Surface," ASTM E 1960-98, Volume 04.03, ASTM, West Conshohocken, Pennsylvania (1999).

ASTM, "Standard Practice for Calculating Pavement Macro-Texture Mean Profile Depth," ASTM E 1845-01, Volume 04.03, ASTM, West Conshohocken, Pennsylvania (2003).

ASTM, "Standard Test Method for Friction Coefficient Measurements Between Tire and Pavement Using a Variable Slip Technique," ASTM E 1859-97, Volume 04.03, ASTM, West Conshohocken, Pennsylvania (1999).

ASTM, "Standard Specification for a Radial Standard Reference Test Tire," ASTM E 1136-93, Volume 04.03, ASTM, Philadelphia, Pennsylvania (1999).

ASTM, "Standard Specification for Standard Smooth Tire for Pavement Skid-Resistance Tests," ASTM E 524-88, Volume 04.03, ASTM, West Conshohocken, Pennsylvania (1993).

ASTM, "Terminology Relating to Vehicle-Pavement Systems," ASTM E 867-02a, Volume 04.03, ASTM, West Conshohocken, Pennsylvania (2003).

ASTM, "Standard Test Method for Determining Longitudinal Peak Braking Coefficient of Paved Surfaces Using a Standard Reference Tire," ASTM E 1337-90, Volume 04.03, ASTM, West Conshohocken, Pennsylvania (1999).

ASTM, "Standard Test Method for Side Force Friction on Paved Surfaces Using the Mu-Meter," ASTM E 670-94, Volume 04.03, ASTM, West Conshohocken, Pennsylvania (1998).

ASTM, "Standard Test Method for Stopping Distance on Paved Surfaces Using a Passenger Vehicle Equipped with Full-Scale Tires," ASTM E 445-88, Volume 04.03, ASTM, West Conshohocken, Pennsylvania (1998).

ASTM, "Standard Specification for Standard Rib Tire for Pavement Skid-Resistance Tests," ASTM E 501-94, Volume 04.03, ASTM, West Conshohocken, Pennsylvania (1998).

ASTM, "Standard Test Method for Measuring Pavement Macro-Texture Depth Using a Volumetric Technique," ASTM E 965-96, Volume 04.03, West Conshohocken, Pennsylvania (1998).

ASTM, "Standard Test Method for Skid Resistance of Paved Surfaces Using a Full-Scale Tire," ASTM E 274-97, Volume 04.03, ASTM, West Conshohocken, Pennsylvania (1998).

ASTM, "Standard Test Method for Measuring Surface Frictional Properties Using the British Pendulum Tester," ASTM E 303-98, Volume 04.03, ASTM, West Conshohocken, Pennsylvania (1993).

ASTM, "Standard Test Method for Skid Resistance Measurements Using the North Carolina State University Variable-Speed Friction Tester," ASTM E 707-90, Volume 04.03, ASTM, West Conshohocken, Pennsylvania (1993).

ASTM, "Standard Practice for the Accelerated Polishing of Aggregates Using the British Wheel," ASTM E 3319-00, Volume 04.03, ASTM, West Conshohocken, Pennsylvania (1999).

ASTM, "Standard Test Method for Measuring Pavement Surface Frictional Properties Using the Dynamic Friction Tester," ASTM E 1911-98, Volume 04.03, ASTM, West Conshohocken, Pennsylvania (1999).

ASTM, "Standard Test Method for Resistance to Degradation of Large-Size Coarse Aggregate by Abrasion and Impact in the Los Angeles Machine," ASTM C 535-01, Volume 04.03, ASTM, West Conshohocken, Pennsylvania (1993).

ASTM, "Standard Test Method for Determining the Polishability of Bituminous Pavement Surfaces and Specimens by Means of the Penn State Reciprocating Polishing Machine," ASTM E 1393, Volume 04.03, ASTM, West Conshohocken, Pennsylvania (1995).

ASTM, "Standard Test Method for Measuring Pavement Macro-Texture Properties Using the Circular Track Meter," ASTM E 2157-01, Volume 04.03, ASTM, West Conshohocken, Pennsylvania (2003).

ASTM, "Standard Specification for A Size 10 x 4-5 Smooth-Tread Friction Test Tire," ASTM E 1844-96, Volume 04.03, ASTM, West Conshohocken, Pennsylvania (1998).

ASTM, "Test Method for Measuring Pavement Texture Drainage Using and Outflow Meter," ASTM WK 364, Volume 04.03, ASTM, West Conshohocken, Pennsylvania (2005).

ASTM, "Standard Specification for Special Purpose Smooth-Tread Tire, Operated on Fixed Braking Slip Continuous Friction Measuring Equipment," ASTM E 1551-93a, Volume 04.03, ASTM, West Conshohocken, Pennsylvania (1993).

ASTM, "Standard Test Method for Resistance of Coarse Aggregate to Degradation and Abrasion in the Micro-Deval Apparatus," ASTM D 6928-03, Volume 04.03, ASTM, West Conshohocken, Pennsylvania (1999).

ASTM, "Standard Guide for Petrographic Examination of Aggregates for Concrete," ASTM C 295-03, Volume 04.03, ASTM, West Conshohocken, Pennsylvania (2005).

ASTM, "Standard Test Methods for Chemical Analysis of Limestone, Quicklime, and Hydrated Lime," ASTM C 25-99, Volume 04.03, ASTM, West Conshohocken, Pennsylvania (1999).

ASTM, "Standard Test Methods for Uncompacted Void Content of Fine Aggregate (as Influenced by Particle Shape, Surface Texture, and Grading)," ASTM C 1252-98, Volume 04.03, ASTM, West Conshohocken, Pennsylvania (1999).

ASTM, "Standard Test Method for Sieve Analysis of Fine and Coarse Aggregates," ASTM C 136-01, Volume 04.03, ASTM, West Conshohocken, Pennsylvania (2005).

ASTM, "Standard Test Method for Resistance to Degradation of Small-Size Coarse Aggregate by Abrasion and Impact in the Los Angeles Machine," ASTM C 131-03, Volume 04.03, ASTM, West Conshohocken, Pennsylvania (2005).

ASTM, "Standard Test Method for Soundness of Aggregates by Use of Sodium Sulfate or Magnesium Sulfate," ASTM C 88-99a, Volume 04.03, ASTM, West Conshohocken, Pennsylvania (1999).

ASTM, "Standard Descriptive Nomenclature for Constituents of Concrete Aggregates," ASTM C 294-98, Volume 04.03, ASTM, West Conshohocken, Pennsylvania (1999).

ASTM, "Standard Specification for Coarse Aggregate for Bituminous Paving Mixtures," ASTM D 692-00, Volume 04.03, ASTM, West Conshohocken, Pennsylvania (2000).

ASTM, "Standard Test Method for Index of Aggregate Particle Shape and Texture," ASTM D 3398-00, Volume 04.03, ASTM, West Conshohocken, Pennsylvania (2000).

ASTM, "Standard Test Method for Flat Particles, Elongated Particles, or Flat and Elongated Particles in Coarse Aggregate," ASTM D 4791-99, Volume 04.03, ASTM, West Conshohocken, Pennsylvania (1999).

ASTM, "Standard Test Method for Determining the Percentage of Fractured Particles in Coarse Aggregate," ASTM D 5821-01, Volume 04.03, ASTM, West Conshohocken, Pennsylvania (2003).

ASTM, "Standard Practice for Accelerated Polishing of Aggregates or Pavement Surfaces Using a Small-Wheel, Circular Track Polishing Machine," ASTM E 660-02, Volume 04.03, ASTM, West Conshohocken, Pennsylvania (2003).

ASTM, "Standard Specification for Aggregate for Single or Multiple Bituminous Surface Treatments," ASTM D 1139-00, Volume 04.03, ASTM, West Conshohocken, Pennsylvania (2000).

ASTM, "Standard Test Method for Insoluble Residue in Carbonate Aggregates," ASTM D 3042-03, Volume 04.03, ASTM, West Conshohocken, Pennsylvania (2005).

Ananthanarayanan, K., J. Parikh, and S. Munjal, "The Effects of Tire Tread Depth on Friction Numbers of Dense and Open-Graded Surfaces," Report No. FHWA/MD-86/05, Maryland State Highway Administration, Brooklandville, Maryland (1986).

Anderson, D.A., R.S. Huebner, J.R. Reed, J.C. Warner, and J.J. Henry. 1998. *Improved Surface Drainage of Pavements*, NCHRP Web Document 16, National Cooperative Highway Research Foundation (NCHRP), Washington, D.C.

Andresen A. and J.C. Wambold, "Friction Fundamentals, Concepts and Methodology," TP 13837E, Transportation Development Centre, Canada (1999).

Andrey J., B. Mills, and J. Vandermolen, "A Temporary Analysis of Weather-Related Collision Risk for Ottawa, Canada: 1990-1998," 03-3488, Transportation Research Board (TRB), Washington, D.C. (2003).

Anfosso-Ledee, F. and M. Do, "Geometric Descriptors of Road Surface Texture in Relation to Tire/Road Noise," Transportation Research Board (TRB), Washington, D.C. (2002).

Apostolos, J.A., R.N. Doty, B.G. Page, and G.B. Sherman, "California Skid Resistance Studies," CA-DOT-TL-3126-9-74-10, California Department of Transportation (CALTRANS), Sacramento, California (1974).

Ardani A., "PCCP Texturing Methods, Final Report" Report No. CDOT-DTD-R-00-1, Colorado Department of Transportation (CODOT), Denver, Colorado (2000).

Arizona Department of Transportation (ADOT), "Governor Hull Unveils Plan to Add Rubberized Asphalt to Majority of Valley Freeway System," ADOT, Phoenix, Arizona (2002).

Arizona Department of Transportation (ADOT), "Adding Rubberized Asphalt to Majority of Valley Freeways," ADOT, Phoenix, Arizona (2003).

Arizona Department of Transportation (ADOT), "Winslow Arizona Sealer/Rejuvenator Pilot Study," ADOT, Phoenix, Arizona (2001).

Austrroads, "Guidelines for the Management of Road Surface Skid Resistance," Austrroads Publication No. AP-G83/05, Austrroads Incorporated, Sydney, Australia (2005).

Balmer, G.G. and B.M. Gallaway, "Hydroplaning - How to Reduce It," *Public Roads* Volume 47, No.1, Federal Highway Administration (FHWA) Washington, D.C. (1983).

Becot, F.X., "Oriented Study of the Tyre/Road Noise Including the Ground Effects," Report No. F-01-05, Thesis for Chalmers University of Technology (2001).

Berge, P.L., K. Travis, and Z. Rado, "A Comparison of Transverse Tined and Longitudinal Diamond Ground Pavement Texturing for Newly Constructed Concrete Pavement," Transportation Research Board (TRB), Washington, D.C. (2001).

Bernhard, R.J., W.D. Thornton, and J. Baumann, "The Effects of Varying the Tire Cap Ply, Sidewall Filler Height and Pavement Surface Texture on Tire/Pavement Noise Generation," Final Report, SQDH 2003 – 1, The Institute for Safe, Quiet and Durable Highways (ISQDH), Purdue University, West Lafayette, Indiana (2003).

Bester, C.J., "The Effect of Road Roughness on Safety," Transportation Research Board (TRB), Washington, D.C. (2003).

Billera, D., B. Schmidt, and W. Miller, "Stop the Whine! Band Noise Level Measurements of Three Highway Pavements," Committee A1F04 of Transportation Research Board (TRB), Washington, D.C. (1997).

Bloem, D.L., "Skid Resistance: The Role of Aggregates and Other Factors," *Circular No. 109*, National Sand and Gravel Association, Silver Spring, Maryland (1971).

Blue, D.W. and B.T. Kulakowski, "Effects of Horizontal Curve Transition Design on Truck Roll Stability," Federal Highway Administration (FHWA), *Journal of Transportation Engineering*, Vol. 117, No. 1, University Park, Pennsylvania (1991).

Bransford, T.L., "Analysis of Pavement Slipperiness in Alabama," Special Technical Publication 530, American Society for Testing and Materials (ASTM), Philadelphia, Pennsylvania (1973).

Brown, E.R., P.S. Kandhal, and J. Zhang, "Performance Testing for Hot Mix Asphalt," NCAT Report No. 01-05, National Center for Asphalt Technology (NCAT), Auburn, Alabama (2001).

Brown, E.R., L.A. Cooley, Jr., and D. Hanson, "NCAT Test Track Design, Construction, and Performance," NCAT Report No. 02-12, National Center for Asphalt Technology (NCAT), Auburn, Alabama (2002).

Brown, E.R., B. Powell, R. West, and D. Timm, "Summary of NCAT Test Track Findings," Volume 4, Number 3 (Spring Issue) *Southeastern Superpave Center News*, National Center for Asphalt Technology (NCAT), Auburn, Alabama (2005).

Buch, N.B., R. Lyles, and L. Becker, "Cost Effectiveness of European Demonstration Project: I-75 Detroit," RC-1381, Michigan Department of Transportation (MDOT), Lansing, Michigan (1999).

Burns, J.C., W.C. Meyer, G.F. Hayhoe, and D.L. Ivey, "The Influence of Roadway Surface Discontinuities on Safety (Chapter 5 - Friction Variations)," Transportation Research Board (TRB), Washington, D.C. (1984).

Button, J.W., E.G. Fernando, and D.R. Middleton, "Synthesis of Pavement Related to High-Speed Corridors," Research and Technology Implementation Office, Texas Department of Transportation (TXDOT), Austin, Texas (2004).

California Department of Public Works, "A Fact-Finding Study on the Effects of Grooved and Textured Pavements on Motorcyclists," Assembly Resolution 101, California Department of Public Works (1973).

California Department of Transportation (CALTRANS), "California Transportation Journal," Volume 3, Issue 4, CALTRANS, Sacramento, California (2003).

Canadian Strategic Highway Research Program (C-SHRP), "PCC Pavements: Some Findings from US-LTPP and Canadian Case Studies," *Technical Brief #22*, C-SHRP, Ottawa, Ontario (2001).

Cardon, M.H., G.B. Hickner, R.W. Rothfusz, and L.H.M. Schlos, "Skidding Accidents - Ancillary Papers," *Transportation Research Record 624*, Transportation Research Board (TRB), Washington, D.C. (1976).

Cathy, T.I., W.C. Burnett, and M.D. Armstrong, "Research on Skid Resistance," RB114, Department of Highways, Ontario, Canada (1966).

Cenek, P.D., N.J. Jamieson, and J.I. Towler, "The Influence of Texture Depth on Skidding Resistance," Transit New Zealand (1999).

Cenek, P.D., S. Fong, and J. Donbavand, "New Zealand's Experience in Applying the International Friction Index to Coarse Textured Road Surfaces," Transit New Zealand (1998).

Chelliah, T., P. Stephanos, M. Shah, and T. Smith, "Developing a Design Policy to Improve Pavement Surface Characteristics," Paper presented at 82nd Annual Meeting of the Transportation Research Board (TRB), Washington, D.C. (2003).

Choubane, B., G.A. Sholar, J.A. Musselman, and G.C. Page, "A Ten-Year Performance Evaluation of Asphalt-Rubber Surface Mixes," *Transportation Research Record 1681*, Transportation Research Board (TRB), Washington, D.C. (1999).

Correa, A.L. and B. Wong, "Concrete Pavement Rehabilitation: Guide for Diamond Grinding," Technical Bulletin, Federal Highway Administration (FHWA), Washington, D.C. (2001).

- Costello, S.B., "Researchers Gather Friction Data for Aviation Safety Standards," ASTM, West Conshohocken, Pennsylvania (2000).
- Crawford, R.A., D.C. Mahone, S.N. Runkle, and E. Zube, "Surface Treatments, Skid Resistance and Aggregates (6 reports)," *Highway Research Record 236*, Highway Research Board (HRB), Washington, D.C. (1968).
- Crouch, L.K., G. Shirley, G. Head, and W.A. Goodwin, "Aggregate Polishing Resistance Pre-Evaluation," *Transportation Research Record 1530*, National Cooperative Highway Research Program (NCHRP), Washington, D.C. (1996).
- Dahir, S.H. and J.J. Henry. 1978. *Alternatives for the Optimization of Aggregate and Pavement Properties Related to Friction and Wear Resistance*, Report No. FHWA-RD-78-209, Federal Highway Administration (FHWA), Washington, D.C. (1978).
- D'Angelo, J., "Superpave and Aggregate Properties: Where Did They Come From?" Office of Technology Applications, Federal Highway Administration (FHWA), Washington, D.C. (1997).
- Daughaday, H., G.G. Balmer, R. Schonfeld, B.E. Quinn, H. Engja, and J.L. Zable, "Pavement Slipperiness, Roughness, and Condition Evaluation (7 reports)," *Highway Research Record 311*, Highway Research Board (HRB), Washington, D.C. (1970).
- Davis, R.M., "Comparison of Surface Characteristics of Hot-Mix Asphalt Pavement Surfaces at the Virginia Smart Road," Thesis submitted to the faculty of Virginia Polytechnic Institute and State University, Blacksburg, Virginia (2001).
- Davis, R.M., G.W. Flintsch, I.L. Al-Qadi, and K.K. McGhee, "Effect of Wearing Surface Characteristics on Measured Pavement Skid Resistance and Texture," Paper presented at 81st Annual Meeting of the Transportation Research Board, Washington, D.C. (2002).
- DeMoss J., B.J. Landsberger, and M.T. McNerney, "Improving the Acoustical Performance of Porous Asphalt Pavements," Report No. FHWA/TX-7-2957-1, FHWA/TXDOT, Austin, Texas (1999).
- Descornet, G. and F. Fuchs, "Concrete Paving Texture," International Workshop on Noise Reducing Concrete (1992).
- Descornet, G., F. Fuchs, and R. Buys, "Noise Reducing Concrete Pavements," Fifth International Conference on Concrete Pavement Design (1993).
- Dewey, G.R., A.C. Robards, B.T. Armour, and R. Muethel, "Aggregate Wear and Pavement Friction," Paper presented at Annual Meeting of the Transportation Research Board, Washington, D.C. (2001).
- Dillard, J.H. and R.A. Alwood, "Providing Skid-Resistant Roads in Virginia," Volume 26, Association of Asphalt Pavement Technologists (AAPT) Proceedings (1957).

Dillard, J.H. and D.C. Mahone, "Measuring Road Surface Slipperiness," Special Technical Publication No. 366, American Society for Testing and Materials (ASTM), Atlantic City, New Jersey (1963).

Domenichini, L., "Road Safety and the VERT Project Research Tasks," University of Florence, Florence, Italy (2001).

Doty, R.N., "A Study of the Sand Patch and Outflow Meter Methods of Pavement Surface Texture Measurement," American Society for Testing and Materials (ASTM), Annual Meeting Symposium on Surface Texture (1974).

Dougan, C.E., "Wet-Weather High-Hazard Locations Identification and Evaluation," Final Report, 403-F-79-4, Connecticut Department of Transportation, Hartford, Connecticut (1979).

Drakoupoulos, A., T.H. Wenzel, S.F. Shober, and R.B. Schmiedlin, "Crash Experience on Tined and Continuously Ground Portland Cement Concrete Pavements," *Transportation Research Record 1639*, Transportation Research Board (TRB), Washington, D.C. (1998).

Dunn, J.R., M.J. Giguere, E.K. Graham, M.J. Hart, and L. Ray, "Symposium on Reducing Constraints on Mineral Aggregate Development," *Transportation Research Record 989*, Transportation Research Board (TRB), Washington, D.C. (1984).

Ehrlich, I.R., A.R. Schaefer, and G.A. Wray, "Parameters Affecting Model-Tire Hydroplaning and Rolling Restoration," SIT-DL-70-1405, National Aeronautics and Space Administration (NASA), Hoboken, New Jersey (1970).

Elsenaar, P.M.W., J. Reichert, R. Sauterey, G.F. Salt, and J.L. Beaton, "Skidding Accidents - Pavement Characteristics," *Transportation Research Record 622*, Transportation Research Board (TRB), Washington, D.C. (1977).

Emery, J.J., W. Schenk, J.J. Carrick, J.K. Davidson, W.K. MacInnis, and G.J.A. Kennepohl. 1993. "Stone Mastic Asphalt Trials in Ontario," *Transportation Research Record 1427*, Transportation Research Board, Washington, D.C.

European Commission, "Future Noise Policy," European Commission, Brussels, Belgium (1996).

Finn, F.N. and J.A. Epps, "Correction of Bleeding (Flushing) Surfaces," Research Report 214-28, Texas Transportation Institute (TTI), College Station, Texas (1981).

Farnsworth, E.E. and M.H. Johnson, "Reduction of Wet Pavement Accidents on Los Angeles Metropolitan Freeways," SAE Mid-year Meeting, California Department of Highways, Sacramento, California (1971).

Federal Aviation Administration (FAA), "Measurement, Construction, and Maintenance of Skid-Resistant Airport Pavement Surfaces," Advisory Circular No. 150/5320-12C, FAA, Washington, D.C. (2004).

Federal Highway Administration (FHWA), "Texturing and Skid Resistance of Concrete Pavements and Bridge Decks," *Technical Advisory T 5140.10*, FHWA, Washington, D.C. (1979).

FHWA, "Skid Accident Reduction Program," *Technical Advisory T 5040.17*, FHWA, Washington, D.C. (1980).

FHWA, "Surface Texture for Asphalt and Concrete Pavements," *Technical Advisory T 5040.36*, FHWA, Washington, D.C. (2005).

FHWA, "Open-Graded Friction Courses," *Technical Advisory T 5040.31*, FHWA Office of Pavement Technology, Washington, D.C. (1990).

FHWA, "PCC Surface Texture Technical Working Group Findings," FHWA, Washington, D.C. (1996).

FHWA, *Manual on Uniform Traffic Control Devices (MUTCD) for Streets and Highways: 2003 Edition*, FHWA, Washington, D.C. (2004).

Ferrara, T.C., J.P. Mahoney, and J.A. Epps, "Skid Resistance of Different Gravel Surfaces in District 25," 214-24, Texas State Dept. of Highways and Public Transportation, College Station, Texas (1981).

Fitzpatrick, K., P. Carlson, M.A. Brewer, M.D. Wooldridge, and S. Miaoud, "Design Speed, Operating Speed, and Posted Speed Practices," *NCHRP Report 504*, National Cooperative Highway Research Foundation (NCHRP), Washington, D.C. (2003).

Flintsch G W, E. De Leon, K.K. McGhee, and I.L. Al-Qadi, "Pavement Surface Macrotecture Measurement and Application," Transportation Research Board (TRB), Washington, D.C. (2003).

Flintsch, G.W., I.L. Al-Qadi, R. Davis, and K.K. McGhee, "Effect of HMA Properties on Pavement Surface Characteristics," *Proceedings of the Pavement Evaluation 2002 Conference*, Roanoke, Virginia.

Folliard, K.J. and K.D. Smith, "Aggregate Tests for Portland Cement Concrete Pavements: Review and Recommendations," September edition (No. 281) of *NCHRP Research Results Digest*, National Cooperative Highway Research Program (NCHRP), Washington, D.C. (2003).

Foster, C.R., "The Effect of Voids in Mineral Aggregate on Pavement Performance," National Asphalt Pavement Association (NAPA) (1986).

Frye, D.J., "Sandstone Aggregate Sprinkle Treatment Surface," 611-1, Texas State Dept. of Highways and Public Transportation, San Antonio, Texas (1975).

Frye, D.J., "Heater Scarifier Recycling of Limestone Rock Asphalt Pavement and Sandstone Sprinkle Treatment," 618-3, Texas State Dept. of Highways and Public Transportation, D'Harris, Texas (1976).

Frye, D.J., "Experimental Pavement Surface Improvement Using Heater Planer Sprinkle Treatment With Sandstone Aggregate on I.H. 10 West San Antonio, Texas," 618-2, Texas State Dept. of Highways and Public Transportation, San Antonio, Texas (1976).

Frye, D.J., "Lightweight Aggregate Sprinkle Treatment Surface," 612-1, Texas State Dept. of Highways and Public Transportation, Medina County, Texas (1975).

Galloway, B.M. et al., "Tentative Pavement and Geometric Design Criteria For Minimizing Hydroplaning," Report No.FHWA-RD-75-11, Federal Highway Administration (FHWA), Washington D.C. (1975).

Galloway, B.M., D.L. Ivey, G. Hayes, W.B. Ledbetter, R.M. Olson, and D.L. Woods, "Pavement and Geometric Design Criteria For Minimizing Hydroplaning," FHWA-RD-79-31, Federal Highway Administration (FHWA), Washington, D.C. (1979).

Galloway, B.M., "Use and Effect of Fillers in Asphalt Paving Mixtures," Texas Transportation Institute (TTI), Texas A&M University, College Station, Texas (1982).

Galloway, B.M., "Suggested Guides For Use of Lightweight Aggregates in Plant Mixed Asphalt Paving Materials," Texas State Department of Highways and Public Transportation, College Station, Texas (1980).

Galloway, B.M., "Uniroyal-Goodrich "30" Surface Special Specification Guides," Mario Herrera (President) Uniroyal Proving Grounds, Laredo Proving Grounds - Hirsch Field (1987).

Galloway, B.M., "Goodyear Tire and Rubber Company: Specifications for "30" Surface," Goodyear Tire and Rubber Company, Bryan, Texas (1990).

Galloway, B.M., D.A. Bass, K.W. Fults, and C.H. Little, "Open Graded Friction Courses in Texas - Specifications, Design, Construction and Maintenance," Texas Transportation Institute (TTI), Texas A&M University, College Station, Texas (1986).

Galloway, B.M., J.W. Button, R.L. Lytton, and O.J. Pendleton, "Wet Weather Exposure Measures," RF-84-796, Texas Transportation Institute - Texas A&M, College Station, Texas (1984).

Gandhi, P.M., B. Colucci, and S.P. Gandhi, "Polishing of Aggregates and Wet-Weather Accident Rates for Flexible Pavements," *Transportation Research Record 1300*, Transportation Research Board (TRB), Washington, D.C. (1991).

Gillespie, T.D., *Fundamentals of Vehicle Dynamics*, Society of Automotive Engineers (SAE), Warrendale, Pennsylvania (1992).

Glennon, J.C., "A Determination Framework for Wet Weather Speed Limits," Criterion Press (1971).

Glennon, J.C., "Roadway Defects and Tort Liability," Lawyers & Judges Publishing Company, Inc., Tucson, Arizona (1996).

Gray, J.E. and F.A. Renninger, "The Skid-Resistant Properties of Carbonate Aggregates," Record No.120,p18, Highway Research Board (1966).

Grealy, P.J. and W.R. McShane, "Tire-Pavement Noise: An Investigation of its Importance in Mitigating Highway Noise Impacts" Paper presented at 77th Annual Meeting of the Transportation Research Board, Washington, D.C. (1998).

Hall, J.W., "Deterioration of Skid Resistance," Research Paper for CE 684, Auburn University, Auburn, Alabama (1989).

Halstead, W.J., "Criteria for Use of Asphalt Friction Surfaces,"104, American Association of State Highway and Transportation Officials (FHWA), Charlottesville, Virginia (1983).

Hankins, K.D. and J.P. Underwood, "Two Aids For Field Personnel in Reducing Skidding Accidents," 135-7F, Texas State Dept. of Highways and Public Transportation, Austin, Texas (1975).

Hanson, D.I. and B.D. Prowell, "Evaluation of Circular Texture Meter for Measuring Surface Texture of Pavements," NCAT Report No. 04-05, National Center for Asphalt Technology (NCAT), Auburn, Alabama (2004).

Hanson, D.I. and B. Waller, "Evaluation of the Noise Characteristics of Minnesota Pavements," Minnesota Department of Transportation (MNDOT), St. Paul, Minnesota (2005).

Harm, E.E. and C.S. Hughes, "Paving Specifications and Inspection Related to Pavement Performance," Volume 58, Association of Asphalt Paving Technologists (AAPT), Nashville, Tennessee (1989).

Harmelink, D., "Stone Mastic Asphalt in Colorado," Report No. CDOT-DTD-R-2001-1, Colorado Department of Transportation (CDOT), Denver, Colorado (2001).

Hayes, G.G., D.L. Ivey, and B.M. Gallaway, "Hydroplaning, Hydrodynamic Drag, and Vehicle Stability," *Special Technical Publication 793*, American Society for Testing and Materials (ASTM), Philadelphia, Pennsylvania (1983).

Henry, J.J., "Evaluation of Pavement Friction Characteristics," *NCHRP Synthesis 291*, National Cooperative Highway Research Program (NCHRP), Washington, D.C. (2000).

Henry, J.J., J.L. Burchett, R.L. Rizenbergs, and S.K. Agrawal, "Interaction Between Vehicles and Pavement Surfaces," *Transportation Research Record 788*, Transportation Research Board (TRB), Washington, D.C. (1980).

Herman, L.A. and J.M. Withers, “Effectiveness of Tire/Road Noise Abatement Through Surface Retexturing by Diamond Grinding for Project SUM-76-15.40,” Final Report, Ohio Department of Transportation (ODOT) District 4, Athens, Ohio (2005).

Hight, P.V., J.B. Wheeler, and T.J. Reust, “The Effects of Right Side Water Drag on Vehicle Dynamics and Accident Causation,” 900105, SAE, The Engineering Society for Advancing Mobility Land Sea Air And Space, Warrendale, Pennsylvania (1990).

Highway Environment Branch, “Revised Policy for Mitigating the Effects of Traffic Noise from Freeways and Expressways,” Ministry of Transportation and Highway, Victoria, British Columbia, Canada (1993).

Highway Innovative Technology Evaluation Center (HITEC), Evaluations—Italgrip System, Civil Engineering Research Foundation (CERF) HITEC website (www.cerf.org/hitec/evals.htm), Washington D.C. (2003).

Highways Agency (HA), *Design Manual for Roads and Bridges*, Volume 7, HD 28, “Skid Resistance,” Department for Transport, London, United Kingdom (2004).

Hill, R., N. Peterson, M. Santesson, M. Uchanski, and J.K. Hedrick, “Tire-Road Friction Estimation”

His, A. and G. Magnusson, “The Significance of Various Road Surface Properties for Traffic and Surroundings,” VIT Notat 71A-2000, Swedish National Road and Transport Research Institute (2000).

Hoerner, T.E., K.D. Smith, R.M. Larson, and M.E. Swanlund, “Current Practice of PCC Pavement Texturing,” Paper presented at 82nd Annual Meeting of the Transportation Research Board, Washington, D.C. (2003).

Hoerner, T.E. and K.D. Smith, *High Performance Concrete Pavement: Pavement Texturing and Tire-Pavement Noise*, Report No. FHWA-IF-02-020, Federal Highway Administration (FHWA), Washington, D.C. (2002).

Holmgreen, R.J., Jr., J.A. Epps, C.H. Hughes, and B.M. Gallaway, “Field Evaluation of the Texas Seal Coat Design Method,” Association of Asphalt Paving Technologists Meeting Presentation, College Station, Texas (1985).

Horne, W.B., “Traction Performance of New (E524) and Old (E249) ASTM Smooth Tread Test Tires on Several Wet and Dry Pavements,” NASA Langley Research Center (1975)

Hosking, J.R., “Aggregates for Skid-Resistant Roads,” ISSN 0305-1293, Dept. of the Environment, Transport and Road Research Laboratory, Crowthorne, Berkshire, U.K. (1976).

Howe, R.H., “Classification of Aggregates by the Skid Resistance of Bituminous Concrete Pavements: The PennDOT SRL System,” Pennsylvania Department of Transportation (1975).

Huft, D.L., I. Her, J.J. Henry, J.C. Wambold, and S.K. Agrawal, "Surface Properties - Vehicle Interaction," *Transportation Research Record 1000*, Transportation Research Board (TRB), Washington, D.C. (1984).

Hunt, L., "Millabrading Test Evaluation," Report No. FHWA-OR-RD-00-02, Oregon Department of Transportation (ODOT), Salem, Oregon (1999).

Hunt, E.A., "Crumb Rubber Modified Asphalt Concrete in Oregon," Report No. FHWA-OR-RD-02-13, Oregon Department of Transportation (ODOT), Salem, Oregon (2002).

Hyman, T. and S. Hakkert, "A Road Friction Survey and Study of Skidding Accidents in Israel," Publication no. 73/9, Road Safety Centre, Israel Ministry of Transport, Haifa, Israel (1973)

Hutchinson, J.W., "Skid Resistance, A Summary," International Bridge, Tunnel & Turnpike Association, New Orleans, Louisiana (1969).

Ihs, A. and G. Magnusson, "The Significance of Various Road Surface Properties for Traffic and Surroundings," VTI Report No. 71A-2000, Swedish National Road and Transport Research Institute (VTI), Linkoping, Sweden (2000).

Ingulstad, A., "New Friction Measuring Device for Safer Driving During Winter," No 2, 2000, Nordic Road & Transport Research (2000).

D.L. Ivey, L.I. Griffin, T.M. Newton, K.D. Hankins, C.W. Blumentritt, and R.L. Lytton, "Development of a Wet Weather Safety Index," Research Report 221-1F, Texas Transportation Institute (TTI), College Station, Texas (1977).

Ivey, D.L., L.I. Griffin III, J.R. Lock, "Proposed Program to Reduce Skid Initiated Accidents in Texas," 9100, The Texas State Department of Highways and Public Transportation, Austin, Texas (1990).

Ivey, D.L., L.I. Griffin III, J.R. Lock, and D.L. Bullard, "Texas Skid Initiated Accident Reduction Program," Final Report, Research Report 910-1F, TTI: 2-18-89/910, TX-92/910-1F, Texas Department of Transportation, Austin, Texas (1992).

Ivey, D.L., W.B. Horne, R.D. Tonda, M.S. Janoff, and R.M. Wee, "Pavement Roughness and Skid Resistance," *Transportation Research Record 1084*, Transportation Research Board (TRB), Washington, D.C. (1986).

Jackson, N.M., B. Choubane, and J.A. Musselman, "A Review of Friction Testing in Florida," Pavement Evaluation Conference, Roanoke, Virginia (2002).

Jackson, N.M., B. Choubane, and J.A. Musselman, "A Preliminary Evaluation of FC-5 and FC-6 Friction Courses in Florida," Pavement Evaluation Conference, Roanoke, Virginia (2002).

Jaeckel, J., A. Satanovsky, D.A. Kuemmel, R.C. Sonntag, and Y.Z. Becker, "Noise Issues of Concrete Pavement Texturing," Paper presented at 79th Annual Meeting of the Transportation Research Board, Washington, D.C. (2000).

Janson, B.N. and E. Karimkhani, "Cost Effectiveness of Infrastructure Improvement versus Behavioral Programs to Reduce Traffic Accidents," Transportation Research Board (TRB), Washington, D.C. (2001).

Jayawickrama, P.W., R. Prasanna, and S.P. Senadheera, "Survey of State Practices to Control Skid Resistance on Hot-Mix Asphalt Concrete Pavements," *Transportation Research Record 1536*, Transportation Research Board (TRB), Washington, D.C. (1996).

Jones, W., "Highway Noise Control with HMA," Asphalt Institute (2002)

Kalb, M.R. and P.J. Willing, "Summary of Statewide Skid Resistance Surveys 1972 New Construction and Resurfacing Program," Project No. 3.3, Maryland State Highway Administration, Brookland, Maryland (1973).

Kandhal, P.S., G.W. Maupin, Jr., T.W. Kennedy, and A.S. Adedimila, "Bituminous Materials and Skid Resistance," *Transportation Research Record 712*, Transportation Research Board (TRB), Washington, D.C. (1979).

Kandhal, P.S. and R.B. Mallick, "Open-Graded Asphalt Friction Course: State of the Practice," NCAT Report No. 98-7, National Center for Asphalt Technology (NCAT), Auburn, Alabama (1998).

Kandhal, P.S. and R.B. Mallick, "Design of New-Generation Open-Graded Friction Courses," NCAT Report No. 99-3, National Center for Asphalt Technology (NCAT), Auburn, Alabama (1999).

Kandhal, P.S. and E.A. Bishara, "Evaluation of Limestone Coarse Aggregate in Asphalt Concrete Wearing Courses - Phase II," IR-92-03, National Center for Asphalt Technology (NCAT), Auburn University, Alabama (1992).

Kandhal, P.S., F. Parker Jr., and R.B. Mallick, *Aggregate Tests for Hot Mix Asphalt: State of the Practice*, NCAT Report No. 97-6, National Center for Asphalt Technology (NCAT), Auburn, Alabama (1997).

Kandhal, P.S. and F. Parker Jr., "Aggregate Tests Related to Asphalt Concrete Performance in Pavements," *NCHRP Report 405*, National Cooperative Highway Research Program (NCHRP), Washington, D.C. (1998).

Karr, J.I., "Evaluation of Minor Improvements (Part 8), Grooved Pavements," CA-HY-TR-2151-4-71-00, California Division of Highways, Sacramento, California (1972).

Kazmierowski, T.J. and A. Bradbury, "Ten-Year Evaluation of a Concrete Pavement Rehabilitation Project in Ontario," Paper presented at 78th Annual Meeting of the Transportation Research Board, Washington, D.C. (1999).

Kentucky Transportation Center, "Kentucky Traffic Collision Facts 2000," University of Kentucky, Lexington, Kentucky (2000).

Kuemmel, D.A., J.R. Jaeckel, A. Satanovsky, S.F. Shoher, and R.B. Schmiedlin, "Impacts Related to Pavement Texture Selection," Report Number WI/SPR-06-96, Wisconsin Department of Transportation, Madison, Wisconsin (1997).

Kuemmel, D.A., J.R. Jaeckel, and A. Satanovsky, *Investigative Study of the Italgrip System: Noise Analysis*, Report No. WI/SPR-02-00, Wisconsin Department of Transportation, Madison, Wisconsin (2000).

Kuemmel, D.A., R.C. Sonntag, J. Crovetto, and Y. Becker, "Noise and Texture on PCC Pavements: Results of a Multi-State Study," Final Report No. WI/SPR-08-99, Wisconsin Department of Transportation, Madison, Wisconsin (2000).

Kuennen T, "Asphalt Rubber Makes a Quiet Comeback," May issue of *Better Roads* magazine (2004).

Kuennen T, "America's Quest for Premium Aggregates," August issue of *Better Roads* magazine (2004).

Kuennen T, "Polymers Add Performance to Asphalt Emulsions," November issue of *Better Roads* magazine (2004).

Kulakowski, B.T., J.C. Wambold, C.E. Antle, C. Lin, and J.M. Mason, "Development of a Methodology to Identify and Correct Slippery Pavements," FHWA-PA90-002+88-06, The Pennsylvania Transportation Institute, State College, Pennsylvania (1990).

LaForce, R. and J. Schlaefer, "Noise and Skid Measurements on US 285 in the Turkey Creek Canyon Area, Project NH 2854-068," CDOT R1-R-2001-9, CO DOT (2001).

Larson, R. M., "Using Friction and Texture Data to Reduce Traffic Fatalities, Serious Injuries, and Traffic Delays," Paper presented at International Conference on Surface Friction for Roads and Runways, Christchurch, New Zealand (2005).

Larson, R.M., "Consideration of Tire/Pavement Friction/Texture Effects on Pavement Structural Design and Materials Mix Design," Federal Highway Administration, Office of Pavement Technology, Washington, D.C. (1999).

Larson, R., L. Scofield, and J. Sorenson, "Pavement Functional Surface Characteristics," Paper presented at 5th Symposium of Pavement Surface Characteristics, Toronto, Ontario Canada (2004).

Li, S. and K. Zhu, "Upgrading the INDOT Pavement Friction Testing Program," Final Report, Report No. FHWA/IN/JTRP-2003/23, Indiana Department of Transportation (INDOT), Indianapolis, Indiana (2003).

Liang, R.Y. 2003. "Blending Proportions of High Skid and Low Skid Aggregate," Final Report prepared for Ohio Department of Transportation (ODOT), Columbus, Ohio (2003).

Liang, R.Y. and L.L. Chyi, "Polishing And Friction Characteristics Of Aggregates Produced in Ohio," Report No. FHWA/OH-2000/001, Ohio Department of Transportation, Columbus, Ohio (2000).

Mahone, D.C. and S.N. Runkle, "Pavement Friction Needs," *Highway Research Record 396*, Highway Research Board, Washington D.C. (1972).

Mahone, D.C. and C. Sherwood, "The Effect of Aggregate Type and Mix Design on the Wet Skid Resistance of Bituminous Pavement: Recommendations for Virginia's Wet Accident Reduction Program," VTRC Report No. 96-R10, Virginia Department of Transportation (VDOT), Richmond, Virginia (1995).

Mahone, D.C., C. Sherwood, "Virginia's Wet Accident Reduction Program: A User's Manual," Virginia Transportation Research Council, Charlottesville, Virginia (1996).

Manglorkar, D., P.S. Kandhal, F. Parker, Jr., "Evaluation of Limestone Coarse Aggregate in Asphalt Concrete Wearing Courses," Project No. 2019-10, Alabama DOT, Bureau of Research and Development, Auburn University, Auburn, Alabama (1993).

Martinez, J.E., "Effects of Pavement Grooving on Friction, Braking, and Vehicle Control," *Transportation Research Record 633*, Transportation Research Board, Washington, D.C. (1977).

McDaniel, R.S. and B.J. Coree, "Identification of Laboratory Techniques to Optimize SuperPave HMA Surface Friction Characteristics," Phase I Final Report, SQDH 2003-6, HL 2003-19, Institute for Safe, Quiet, and Durable Highways (ISQDH), Purdue University, West Lafayette, Indiana (2003).

McGhee, K.K. and G.W. Flintsch, "High Speed Texture Measurement of Pavements," Final Report, Report No. VTRC 03-R9, Virginia Transportation Research Council (VTRC), Charlottesville, Virginia (2003).

McNeal, A.F., "A Summary of the Illinois Skid-Accident Reduction Program 1989-1994," Physical Research Report No. 119, Bureau of Materials and Physical Research, Illinois Department of Transportation, Springfield, Illinois (1995).

McNerney, M.T., B.J. Landsberger, T. Turen, and A. Pandelides, "Comparative Field Measurements of Tire/Pavement Noise of Selected Texas Pavements," Report No. FHWA/TX-7-2957-2, Texas Department of Transportation (TXDOT), Austin, Texas (2000).

McNerney, M.T., B.J. Landsberger, S. Burcsak, J. DeMoss, and W.H. Yeo, "Feasibility of Using Quiet Pavement Technology To Attenuate Traffic Noise In Texas," Report No. 7-2957-3, Texas Department of Transportation, Austin, Texas (2001).

Meegoda, J.N., C.H. Hettiarachchi, G.M. Rowe, N. Bandara, and M.J. Sharrock, "Correlation of Surface Texture, Segregation, and Measurement of Air Voids," Final Report prepared for New Jersey Department of Transportation (NJDOT), Trenton, New Jersey (2002).

Mergenmeier, A.J., "Stone Matrix Asphalt—VDOT's Initiative for Longer Lasting Roads," Paper Presented at Annual Meeting of Southeastern Association of State Highway and Transportation Officials (SASHTO) held in Norfolk, Virginia (2004).

Minnesota Pollution Control Agency, "A Guide to Noise Control in Minnesota," Minnesota Pollution Control Agency, St. Paul, Minnesota (1999).

Mitchell, J.C., "Evaluation of Aggregate Substitutions to Improve Wear Characteristics of Bituminous Concrete," FHWA/MD-88/09, Maryland State Highway Administration, Brooklandville, Maryland (1988).

Mitchell, J.C., M.I. Phillips, and G.N. Shah, "Seasonal Variation of Friction Numbers," FHWA/MD-86/02, Maryland State Highway Administration, Brooklandville, Maryland (1986).

Mockenstrum, E.M., B.T. Kulakowski, and N.M. Hawk, "Measurement and Evaluation of Roadside Noise Generated by Transit Buses," The Institute for Safe, Quiet, and Durable Highways (ISQDH), Purdue University, West Lafayette, Indiana (2002).

Moore, L.M., R.G. Hicks, and D.F. Rogge, "Design, Construction, and Maintenance Guidelines for Porous Asphalt Pavements," Paper presented at 80th Annual Meeting of the Transportation Research Board, Washington, D.C. (2001).

National Asphalt Pavement Association (NAPA) and Federal Highway Administration (FHWA), "Thin Hot Mix Asphalt Surfacing," *Information Series 110*, NAPA, Lanham, Maryland (1995).

National Asphalt Pavement Association (NAPA) and Federal Highway Administration (FHWA), "HMA Pavement Mix Type Selection Guide," *Information Series 128*, NAPA, Lanham, Maryland, FHWA, Washington, D.C. (2001).

National Highway Institute (NHI), *Techniques for Pavement Rehabilitation—A Training Course*, Participant's Manual, Federal Highway Administration (FHWA), Washington, D.C. (1998).

National Highway Traffic Safety Administration (NHTSA), "Report to Congress: Update on the Status of Splash and Spray Suppression Technology for Large Trucks," NHTSA, Washington, D.C. (1998).

National Highway Traffic Safety Administration (NHTSA), Traffic Safety Facts 2003 – A Compilation of Motor Vehicle Crash Data from the Fatality Analysis Reporting System and the General Estimates System, NHTSA website (<http://www-nrd.nhtsa.dot.gov>) (2004).

Neal, B.F., “An Evaluation of PCC Pavement Tine Texturing Patterns,” Report No. FHWA/CA-TL-85/05, California Department of Transportation (CALTRANS), Sacramento, California (1985).

Neal, B.F., D.E. Peck, J.H. Woodstrom, and D.L. Spellman, “Surface Textures for PCC Pavements,” Report No. FHWA-CA-TL-78-14, California Department of Transportation (CALTRANS), Sacramento, California (1978).

Neal, B.F., R.J. Spring, J.H. Woodstrom, and D.L. Spellman, “Pavement Texture Quality Investigation,” Report No. CA-DOT-TL-3126-10-75-07, California Department of Transportation (CALTRANS), Sacramento, California (1975).

Neeley, B.R., “Sprinkle Treatment in Wharton County, Texas,” 612-2, Texas State Department of Highways and Public Transportation, Yoakum, Texas (1978).

Nejad, E., “A Study to Identify Hydroplaning Accidents,” TSD-330-77, Michigan State Highway Commission, Lansing, Michigan (1976).

Nelson, P.M. and S.M. Phillips, “Quieter Road Surfaces,” TRL Annual Review, Transport Research Laboratory (TRL), London, England (1997).

Newcomb, D. and L. Scofield, “Quiet Pavements Raise the Roof in Europe: Scanning Tour Reveals European Practice for Noise Mitigation,” September/October edition of *Hot Mix Asphalt Technology* (2004).

Noyce, D. A., H. U. Bahia, J. M. Yambó, and G. Kim, “Incorporating Road Safety into Pavement Management: Maximizing Asphalt Pavement Surface Friction for Road Safety Improvements,” Draft Literature Review and State Surveys, Midwest Regional University Transportation Center (MRUTC), Traffic Operations and Safety (TOPS) Laboratory, Madison, Wisconsin (2005).

Ohio Department of Transportation (ODOT), “Pavement Preventive Maintenance Program Guidelines,” ODOT Office of Pavement Engineering, Columbus, Ohio (2001).

Ong, G.P. and T.F. Fwa. 2006. “Transverse Pavement Grooving Against Hydroplaning I: Simulation Model,” *Journal of Transportation Engineering*, Volume 132, Number 6, American Society of Civil Engineers (ASCE), Reston, Virginia.

Oregon Department of Transportation (ODOT), “Safety Priority Index System,” ODOT, Salem, Oregon (2003).

Oregon Department of Transportation (ODOT), “Project Safety Management System - Annual Report 2000,” ODOT, Salem, Oregon (2000).

Page, B.G. and L.F. Butas, “Evaluation of Friction Requirements for California State Highways in Terms of Highway Geometrics,” Report No. FHWA/CA/TL 86/01, Federal Highway Administration (FHWA), Washington, D.C. (1986).

Parsons Brinkerhoff Quade and Douglas, Inc., "Roadway Pavement Grinding Noise Study," Final Report, Utah Department of Transportation (UDOT), Salt Lake City, Utah (2000).

Parsons Brinkerhoff Quade and Douglas, Inc., "Report on Tire Noise Along Interstate Route I-95 In The Town of Harrison, New York," New York State Thruway Authority, Albany, New York (2001).

Permanent International Association of Road Congresses (PIARC), "Report of the Committee on Surface Characteristics," *Proceedings of the 18th World Road Congress*, Brussels, Belgium (1987).

Permanent International Association of Road Congresses (PIARC), *International PIARC Experiment to Compare and Harmonize Texture and Skid Resistance Measurements*, Report No. AIPCR-01.040.T, PIARC, Brussels, Belgium (1995).

Phillips, S.M., S. Kollamthodi, and P.A. Morgan, "Classification of Low Noise Road Surfacing," *Internoise 2001*, United Kingdom (2001).

Phillips, S.M., A.R. Parry and B.W. Ferne, "Monitoring the Safety and Environmental Performance of Road Surfaces," *PIARC XXIst World Road Congress* (1999).

Prowell, B.D, J. Zhang, and E.R. Brown, "Aggregate Properties and the Performance of Superpave-Designed Hot Mix Asphalt," *NCHRP Report 539*, National Cooperative Highway Research Program (NCHRP), Washington, D.C. (2005).

Purushothaman, N. and J.T. Tielking, "A Fundamental Study on Sliding Friction," Paper presented at the 8th Annual Meeting of the Tire Society, Akron, Ohio (1989).

Radt, H.S. and W.F. Milliken, *Motions of Skidding Automobiles*, Paper No. 600133 (205A), Society of Automotive Engineers (SAE), Warrendale, Pennsylvania (1960).

Rao, S., H.T. Yu, and M.I. Darter, "The Longevity and Performance of Diamond-Ground Pavements," *R&D Bulletin RD118*, Portland Cement Association (PCA), Skokie, Illinois (1999).

Rizenbergs, R.L., J.L. Burchett, and C.T. Napier, "Skid Resistance of Pavements," Report No. KYHPR-64-24, Part II, Kentucky Department of Highways, Lexington, Kentucky (1972).

Rizenbergs, R.L., J.L. Burchett, C.T. Napier, and J.A. Deacon, "Accidents on Rural Interstate and Parkway Roads and Their Relation to Pavement Friction," *Transportation Research Record 584*, Transportation Research Board (TRB). Washington, D.C. (1976).

Roads and Bridges, "A Texture Message," September Issue of *Roads and Bridges Magazine* (2005).

- Roe, P.G., A.R. Parry, and H.E. Viner, "High and Low Speed Skidding Resistance: The Influence of Texture Depth," TRL Report No. 367, Transport Research Laboratory (TRL), London, United Kingdom (1998).
- Ryell, J., J.J. Hajek, and G.R. Musgrove, "Concrete Pavement Surface Textures in Ontario: Development, Testing, and Performance," Paper presented at Annual Meeting of the Transportation Research Board, Washington, D.C. (1976).
- Saeed, A. and J. Hall, "Accelerated Pavement Testing: Data Guidelines," *NCHRP Report 512*, National Cooperative Highway Research Program (NCHRP), Washington, D.C. (2003).
- Saad, Z., D.A. Kuemmel, K. Ropella, Y.Z. Becker, J.R. Jaeckel, A. Satanovsky, "Design of Randomized Tining Rake for PCC Pavements Using Spectral Analysis," Paper presented at 79th Annual Meeting of the Transportation Research Board (TRB), Washington, D.C. (2000).
- Sandburg, U., "Influence of Road Surface Texture on Traffic Characteristics Related to Environment, Economy, and Safety: A State-of-the-Art Study Regarding Measures and Measuring Methods," VTI Report 53A-1997, Swedish National Road Administration, Borlange, Sweden (1998).
- Sandberg, U. and J.A. Ejsmont, "Texturing of Cement Concrete Pavements to Reduce Traffic Noise Emission," Paper presented at 77th Annual Meeting of the Transportation Research Board (TRB), Washington, DC (1998)
- Sandburg, U. and J.A. Ejsmont, *Tyre/Road Noise Reference Book*, ISBN 91-631-2610-9, Informex, Kisa, Sweden (2002).
- Schmiedlin, R.B. and D. Bischoff, "Stone Matrix Asphalt: The Wisconsin Experience," Report No. WI/SPR-02-02, Wisconsin Department of Transportation (WisDOT), Madison, Wisconsin (2002).
- Schmitt, R.L., A.S. Hanna, J.S. Russell, and E.V. Nordheim, "Pavement Density Measurement Comparative Analysis using Core and Nuclear Methods," University of Wisconsin - Dept. of Civil and Environmental Engineering, Madison, Wisconsin (1996).
- Schulze, K.H., A. Gerbaldi, J. Chavet, L.H.M. Schlosser, and L.W. Hath, "Skidding Accidents - Wet-Weather Accident Experience, Human Factors, and Legal Aspects," *Transportation Research Record 623*, Transportation Research Board (TRB), Washington, D.C. (1976).
- Shuler, T.S., "Performance of Polymer Modified Chip Seals," Report No. FHWA-HPR-NM-87-02, New Mexico State Highway and Transportation Dept., Santa Fe, New Mexico (1989).
- Strathman, J.G., K.J. Dueker, J. Zhang, and T. Williams, "Analysis of Design Attributes and Crashes on the Oregon Highway System," Oregon Department of Transportation (ODOT), Salem, Oregon (2001).

Strong, J.W., "Increased Skid Resistance Through the Utilization of a Heater-Planer," 618-1, Texas State Dept. of Highways and Public Transportation, Ector & Ward Counties, Texas (1976).

Sullivan, B.W., "Development of a Fundamental Skid Resistance Asphalt Mix Design Procedure," Pavement Management Service, Sydney, Australia (2005).

Texas Department of Transportation (TXDOT), "Chapter 5–Wet Weather Accident Reduction Program," *Pavement Design Manual*, TXDOT, Austin, Texas (2004).

Titus-Glover, L. and S.D. Tayabji, "Assessment of LTPP Friction Data," Report No. FHWA-RD-99-037, Federal Highway Administration (FHWA), Washington, D.C. (1999).

Transit New Zealand, "Notes to the Specifications for Skid Resistance Investigation and Treatment Selection," TNZ T10 Notes-2002, Transit New Zealand, Christchurch, New Zealand (2002).

Transit New Zealand, "Specifications for Skid Resistance Investigation and Treatment Selection," TNZ T10-2002, Transit New Zealand, Christchurch, New Zealand (2002).

Uhlmeier, J.S., L.M. Pierce, and J.T. Weston, "Novachip[®]," Post Construction/Performance Report, Report No. WA-RD 568.1, Washington Department of Transportation (WSDOT), Olympia, Washington (2003).

United States Environmental Protection Agency, "Information on Levels of Environmental Noise Requisite to Protect Public Health and Welfare with an Adequate Margin of Safety," The U.S. Environmental Protection Agency, Washington, D.C. (1974).

United States Federal Government, "Code of Federal Regulations: Procedures for Abatement of Highway Traffic and Construction Noise," 23CFR 772, Government Printing Office (GPO), Washington, D.C. (1994).

United States Federal Government, "Code of Federal Regulations: Design Standards for Highways," 23 CFR 625, Government Printing Office (GPO), Washington, D.C. (2005).

United States Federal Government, "Procedures for Abatement of Highway Traffic Noise and Construction Noise," Federal Register Volume 65, Number 250, Washington, D.C. (2000).

Veith, A.G., "Tire Roads Rainfall Vehicles: The Traction Connection," *ASTM Special Technical Publication Vol. No. 793*, American Society for Testing and Materials (ASTM), Philadelphia, Pennsylvania (1983).

Viner H., R. Sinhal, and T. Parry, "Review of UK Skid Resistance Policy," Paper prepared for 5th International Symposium on Pavement Surface Characteristics---Road and Airports, Toronto, Ontario, Canada (2004).

VonTress, M., M. Poduru, and F.C. Benson, "Techniques for Analysis of Skid Resistance Data," Report No. 286-2, Texas State Department of Highways and Public Transportation, Austin, Texas (1979).

Wade, M., R. DeSombre, and D. Peshkin, "High Volume/High Speed Asphalt Roadway Preventive Maintenance Surface Treatments," Final Report, Report No. SD99-09, South Dakota Department of Transportation (SDDOT), Pierre, South Dakota (2001).

Wallman, C.G. and H. Astrom, "Friction Measurement Methods and the Correlation Between Road Friction and Traffic Safety," Swedish National Road and Transport Research Institute, VTI Meddelande 911A, Linkoping, Sweden (2001).

Washington Asphalt Pavement Association (WAPA), "Asphalt Pavement Guide," on-line website www.asphaltwa.com (2004).

Wayson, R.L., "Relationship Between Pavement Surface Texture and Highway Traffic Noise," *NCHRP Synthesis 268*, National Cooperative Highway Research Program (NCHRP), Washington, D.C. (1998).

West, T.R. and K.H. Cho, "Development of a Procedure to Identify Aggregates for Bituminous Surfaces in Indiana," Final Report, Report No. FHWA/IN/JTRP-2000/28, Indiana Department of Transportation (INDOT), Indianapolis, Indiana (2001).

Wilson, D. and R. Dunn, "Polishing Aggregates to Equilibrium Skid Resistance," Department of Civil and Environmental Engineering, University of Auckland, Auckland, New Zealand (no date).

Wilson, E.M., "Roadway Safety Tools for Local Agencies," *NCHRP Synthesis 321*, National Cooperative Highway Research Program (NCHRP), Washington, D.C. (2003).

Woodward, W.D.H., A.R. Woodside, and J.H. Jellie, "Higher PSV and Other Aggregate Properties," Transport and Road Assessment Centre, University of Ulster, Northern Ireland (no date).

Wu, C.L. and M.A. Nagi, "Optimizing Surface Texture of Concrete Pavement," Research and Development Bulletin *RD 111T*, Portland Cement Association (PCA), Skokie, Illinois (1995).

Wu, Y., F. Parker, and K. Kandhal, *Aggregate Toughness/Abrasion Resistance and Durability/Soundness Tests Related to Asphalt Concrete Performance in Pavements*, NCAT Report 98-04, National Center for Asphalt Technology (NCAT), Auburn, Alabama (1998).

Yager, T.J., J.C. Wambold, J.J. Henry, A. Andresen, and M. Bastian, "Joint Winter Runway Friction Program Accomplishments," Pavement Evaluation Conference, Roanoke, Virginia (2002).

Yaron, R. and S. Nesichi, "Alleviating the Skid Resistance Problem: The Israeli Experience," Paper presented at First International Conference on Surface Friction: Roads and Runways, Christchurch, New Zealand (2005).

Zhu K, "Utilizing GIS Technology to Improve INDOT Pavement Friction Data Management and Distribution," Report No. FHWA/IN/JTRP-2000/9, Indiana Department of Transportation (INDOT), Indianapolis, Indiana (2000).

Zimmer, R.A., "Hydroplane and Friction Testing of a Geo Metro, 2 Door, Hatchback," Report No. 400001-CRS, Texas Transportation Institute (TTI), College Station, Texas (1

APPENDIX B
STATE FRICTION SURVEY FORM

PAVEMENT SURFACE FRICTION

1. Provide the following information concerning your agency's friction test methodology:

a. What test standard does your agency use for friction testing?

ASTM E274 _____
ISO XYYY _____
Other _____

b. If the answer to (a) is Other, please explain.

c. What type of equipment does you agency use for friction testing?

	Yes	No
ASTM E 274 skid trailer	<input type="checkbox"/>	<input type="checkbox"/>
Norsemeter variable slip friction tester	<input type="checkbox"/>	<input type="checkbox"/>
Mu-meter trailer	<input type="checkbox"/>	<input type="checkbox"/>
BV-11 skidometer trailer	<input type="checkbox"/>	<input type="checkbox"/>
GripTester trailer	<input type="checkbox"/>	<input type="checkbox"/>
Surface friction tester	<input type="checkbox"/>	<input type="checkbox"/>
Penn State skid trailer	<input type="checkbox"/>	<input type="checkbox"/>
Other _____		

d. For agencies using an ASTM E 274 skid trailer, please specify test tire type:

	Yes	No
Smooth	<input type="checkbox"/>	<input type="checkbox"/>
Ribbed	<input type="checkbox"/>	<input type="checkbox"/>
Other	<input type="checkbox"/>	<input type="checkbox"/>

e. What is the frequency of calibration of test equipment?

Prior to each test
Monthly
Yearly
Other (specify) _____

f. Does your agency use the International Friction Index (IFI) as the index for characterizing pavement surface friction?

Yes **No**

2. What aggregate properties are specified in your design for friction surfaces?

3. What aggregate tests are used to ensure the properties are met?

None _____

4. What is your agency's practice concerning:

a. Surface conditions that trigger restoration/rehabilitation to restore surface friction of in-service pavements?

b. The relationship between pavement surface friction and crash rates?

5. Does your agency have guidelines for the items below to ensure meeting your friction requirements:

- | | | |
|--|-------------------------------------|------------------------------------|
| Use of specific aggregate types (all pavements)? | <input type="checkbox"/> Yes | <input type="checkbox"/> No |
| Surface texture requirements (all pavements)? | <input type="checkbox"/> Yes | <input type="checkbox"/> No |
| Aggregate size, gradation, and shape (all pavements)? | <input type="checkbox"/> Yes | <input type="checkbox"/> No |
| Aggregate polish value (all pavements)? | <input type="checkbox"/> Yes | <input type="checkbox"/> No |
| Mix type (for AC pavements)? | <input type="checkbox"/> Yes | <input type="checkbox"/> No |
| Use of additives and rubber in AC surface mixtures (for AC pavements)? | <input type="checkbox"/> Yes | <input type="checkbox"/> No |
| Surface finishing (for PCC pavements)? | <input type="checkbox"/> Yes | <input type="checkbox"/> No |

6. What is your agency's method(s) for PCC finishing/surface texturing?

- Tining
- Grooving
- Burlap
- Grinding
- Other Please specify

Include information on the dimensions, direction (transverse, longitudinal, skewed), uniformity, and so on, of the surface finishing:

7. What techniques are used by your agency to maintain in-service pavement surface friction?

- Grinding
- Thin overlays
- Micro-surfacing
- Others

PAVEMENT-TIRE NOISE

8a. Do you consider pavement-tire noise in the selection of pavement surface material or pavement surface texture?

For asphalt concrete pavements:

- For urban freeways only
- For urban highways
- No

For portland cement concrete pavements:

- For urban freeways only
- For urban highways
- No

8b. Do you specify pavement surface materials or pavement surface texture for pavement-tire noise concerns?

For asphalt concrete pavements:

- For urban freeways only
- For urban highways
- No

For portland cement concrete pavements:

- For urban freeways only
- For urban highways
- No

9. What types of pavement surface material or pavement texture do you specify for pavement-tire noise concerns?

For AC pavements

- Open-graded (popcorn) mix
- Stone mastic asphalt (SMA)
- Rubberized asphalt _____
- Other _____

For PCC pavements

- Random tining
- Burlap drag
- Grooving
- Grinding
- Other _____

10. Do you have any documentation on the selection of pavement surface materials or textures to minimize pavement-tire noise?

- Yes** **No**

11. What types of pavement-tire noise measurements have you carried out?

	Yes	No
Pass-by measurements of the total traffic flow	<input type="checkbox"/>	<input type="checkbox"/>
Pass-by measurements of individual vehicles	<input type="checkbox"/>	<input type="checkbox"/>
Measurements inside a moving vehicle	<input type="checkbox"/>	<input type="checkbox"/>
Near tire measurements in the field	<input type="checkbox"/>	<input type="checkbox"/>
Near tire measurements in the laboratory	<input type="checkbox"/>	<input type="checkbox"/>
None	<input type="checkbox"/>	<input type="checkbox"/>
Other (please describe) _____		

PAVEMENT SURFACE TEXTURE

12. Is pavement surface texture specified in the selection of pavement surface materials or pavement surface texture?

For asphalt concrete pavements:

- For urban freeways only
- For urban highways
- No

For portland cement concrete pavements:

- For urban freeways only
- For urban highways
- No

13. What kind of pavement surface testing is carried out by your agency?

	Yes	No
Grease sample	<input type="checkbox"/>	<input type="checkbox"/>
Sand patch	<input type="checkbox"/>	<input type="checkbox"/>
Outflowmeter	<input type="checkbox"/>	<input type="checkbox"/>
British pendulum tester	<input type="checkbox"/>	<input type="checkbox"/>
None	<input type="checkbox"/>	<input type="checkbox"/>

14. How often is pavement surface texture testing carried out?

- Never
- Yearly
- Every other year
- Every 5 years
- Only for research purposes

15. Do you have any documentation on how your agency relates pavement surface texture to pavement surface friction and pavement-tire noise?

- Yes**
- No**

16. Do you have any reports papers or data describing the results of pavement surface texture measurements sponsored by your agency that you can share with us?

- Yes**
- No**

17. What are your agency's surface texture enhancement policies?

a. Are there minimum surface texture characteristics for which remedial action is required?

Yes No

b. If yes, what are the requirements?

c. What remedial actions are used to restore surface texture?

Grinding
Thin overlays
Micro-surfacing
Others

SAFETY AND LEGAL ISSUES

18. Do you have documentation on how your agency relates wet pavement surface characteristics (friction and surface texture) to crash rates?

Yes No

REQUEST FOR INFORMATION

19. Do you have any reports, papers, specifications, or other documents describing your agency's requirements for pavement surface friction, surfacing materials and texture specifications and test methods, friction measuring techniques, results of tire noise measurements sponsored by your agency, and any information on friction/crash-related issues and associated legal concerns that you can share with us?

If information is available, please indicate how we might obtain the documents.

APPENDIX C
SUMMARY OF STATE FRICTION SURVEY
RESPONSES

INTRODUCTION

This appendix summarizes the responses provided by state highway agencies that participated in the pavement friction survey conducted in August 2003.

PROCEDURES AND EQUIPMENT USED TO MEASURE PAVEMENT SURFACE CHARACTERISTICS

Pavement Friction

Test Protocol/Procedure

Forty-one of the 45 responding agencies indicated using ASTM E 274 (“Test Method for Skid Resistance of Paved Surfaces Using a Full-Scale Tire”) as the principal protocol for performing pavement surface friction measurements. Arizona uses a test method that corresponds to the modified Dynatest Runway Friction Tester (herein termed Highway Friction Tester) it uses. Vermont, Delaware, and New Hampshire indicated that pavement friction is not measured in the field.

Test Equipment

ASTM E 274 measures the steady-state friction force between a specified full-scale automotive tire and a pavement surface using a locked test wheel as it is dragged over a the wetted pavement surface under constant load and at a constant speed, while its major plane is parallel to its direction of motion and perpendicular to the pavement. All 41 agencies reporting use of the ASTM E 274 test method use the skid trailer equipment specified by the method.

Automotive Tire Type Used in Testing

ASTM E 274 specifies two full-scale automotive tire types (ribbed and smooth tires) that can be used in testing as follows:

- ASTM E 501 (“Standard Specification for Standard Rib Tire for Pavement Skid-Resistance Tests”).
- ASTM E 524 (“Standard Specification for Standard Smooth Tire for Pavement Skid-Resistance Tests”).

Table C-1 summarizes test tires used by the 41 agencies that employ the ASTM E 274. As can be seen, 23 of the 41 agencies use the ribbed tire exclusively, while 12 use both smooth and ribbed tires and the remaining six agencies use only smooth tires. The comments provided as part of responses indicate that the ribbed tire is generally used for network-level testing, while the smooth tire is used for testing in specific situations, such as crash investigations and research.

Table C-1. Test tires used as part of ASTM E 274 pavement surface friction testing.

Agency	Smooth Tire	Ribbed Tire	Notes
Alabama	√	√	
Alaska		√	
Arkansas		√	
California		√	
Colorado	√	√	
Connecticut	√	√	
Florida	√	√	Smooth tire used on accident sites and for research.
Georgia	√	√	
Hawaii		√	
Idaho	√		
Illinois	√	√	Both tires used most of the time.
Indiana	√		
Iowa		√	
Kansas	√	√	Smooth tire used in research.
Kentucky	√	√	
Louisiana	√	√	
Maryland		√	
Maine		√	
Michigan	√	√	Smooth tire for investigations only. Ribbed tire for network-level testing.
Minnesota	√	√	
Mississippi		√	
Missouri	√		
Montana		√	
Nebraska		√	
Nevada		√	
New Jersey		√	
New Mexico		√	
New York		√	
North Carolina		√	
Ohio		√	
Oklahoma	√		Other types noted, but not specified.
Oregon		√	
Pennsylvania	√	√	
Puerto Rico		√	
South Carolina		√	
Tennessee		√	
Texas	√		
Utah		√	
Virginia	√		
Washington		√	
West Virginia		√	

Frequency of Calibration of Test Equipment

As seen in table C-2, there was a wide range of responses concerning the frequency of calibration of test equipment. The responses include both local calibrations of system components (force plate, water flow, etc.) and full system calibrations at statewide or regional calibration sites; the former typically done on a daily, weekly, or monthly basis and the latter done over a period of several months or years.

Table C-2. Frequency of equipment calibrations.

Testing Frequency	Number of Agencies
Prior to Each Test	8
Daily/Weekly	3
Monthly	11
Every 3 to 6 months	3
Yearly	21
Every 2 to 3 years	14
>3 years	1

Use of International Friction Index

The survey inquiry regarding use of the International Friction Index (IFI) shows that only 4 of the 42 states that conduct friction testing—Iowa, Oklahoma, New Mexico, and West Virginia—use IFI to characterize pavement surface friction.

Pavement–Tire Noise

Table C-3 presents a summary of the test methods performed to characterize pavement–tire noise. The information in this table shows that slightly more than half (24) of the 45 responding states do not perform pavement–tire noise testing. Among those that perform noise testing outside of the research realm, pass-by measurement techniques are more commonly used than near-tire techniques. Additionally, fewer agencies measure interior noise, as compared to exterior noise.

Table C-3. Summary of test methods performed to characterize pavement–tire noise.

Agency	Pass-By Measurements of Total Traffic Flow	Pass-By Measurements of Individual Vehicles	Vehicle Interior Measurements	Near-Tire Measurements in Field	Near-Tire Measurements in Lab	NCAT Noise Trailer	None	Notes
Alabama							√	
Alaska							√	
Arizona	√	√	√	√				
Arkansas							√	
California			√	√	√			
Colorado	√	√	√	√				
Connecticut							√	
Delaware							√	
Florida							√	
Georgia			√					
Hawaii							√	
Idaho	√							Most measurements have been individual qualitative observations in urban areas. Plan to be more involved in noise measurement.
Illinois							√	
Indiana							√	
Iowa			√	√				
Kansas		√	√					
Kentucky								Done by Kentucky Transportation Research Center on individual projects.
Louisiana	√	√						Research applications only; using pass-by measurements of total traffic flow and individual vehicles.
Maryland								Office of Env. Design is responsible for noise measurements.
Maine							√	
Michigan	√	√	√	√				

Table C-4. Summary of test methods performed to characterize pavement–tire noise (continued).

Agency	Pass-By Measurements of Total Traffic Flow	Pass-By Measurements of Individual Vehicles	Vehicle Interior Measurements	Near-Tire Measurements in Field	Near-Tire Measurements in Lab	NCAT Noise Trailer	None	Notes
Minnesota		√	√	√				Participated in Marquette University Noise & Texture in PCC Pavements study.
Mississippi							√	
Missouri							√	
Montana							√	
Nebraska							√	
Nevada		√				√		NCAT is performing near-tire measurements for NDOT in Las Vegas on different pavement types and textures. No report yet.
New Hampshire	√							
New Jersey						√		
New Mexico							√	
New York							√	
North Carolina	√							
Ohio	√							
Oklahoma							√	
Oregon							√	
Pennsylvania							√	
Puerto Rico							√	
South Carolina	√							
Tennessee							√	
Texas	√	√		√				
Utah	√							
Vermont							√	
Virginia							√	
Washington							√	
West Virginia							√	

Pavement Surface Texture

Test Methods

Table C-4 summarizes test methods used by the 45 responding agencies to characterize pavement surface texture. The table shows that about half (23) of the states do not conduct surface texture tests. The remaining states typically use one test method, the most common being the sand patch and British Pendulum Tests. Five states—Louisiana, Michigan, Missouri, New Jersey, and Texas—use two or more methods to measure pavement surface texture.

Table C-4. Summary of test methods used to characterize pavement surface texture.

Test Method	Number of Agencies
Grease Sample	0
Sand Patch	15
Outflow Meter	4
British Pendulum Tester	8
Laser Device	2
None	23

Frequency of Pavement Surface Texture Testing

A summary of the information obtained on pavement surface texture testing frequency is presented in table C-5. Examination of this table shows that texture testing is not a regular occurrence in most states, and its adoption as part of pavement evaluation/management is still in its infant stages. The vast majority of states do not perform texture testing or only test texture for research purposes. Only Minnesota and New Jersey reported doing texture testing on a regular basis, while Colorado, Georgia, and Montana indicated testing at time of construction.

Table C-5. Frequency of pavement surface texture testing.

Agency	Testing Frequency						Notes
	Never	Yearly	Every Other Year	Every 5 years	Research Only	At Construction	
Alabama	√						
Alaska	√						
Arizona					√		
Arkansas					√		
California	√						
Colorado					√	√	For acceptance of Astroturf drag.
Connecticut					√		
Delaware					√		
Florida					√		
Georgia					√		
Hawaii					√		
Idaho					√		
Illinois	√						
Indiana					√		
Iowa	√						
Kansas					√		
Kentucky					√		
Louisiana					√		
Maryland	√						
Maine	√						
Michigan					√		Next year, test on 3-year cycle.
Minnesota		√					
Mississippi					√		Testing sometimes done to meet shotblasting specifications.
Missouri	√						
Montana						√	
Nebraska					√		
Nevada					√		
New Hampshire	√						
New Jersey				√			
New Mexico		√					
New York	√						
North Carolina					√		
Ohio					√		
Oklahoma	√						
Oregon	√						
Pennsylvania					√		
Puerto Rico					√		
South Carolina	√						
Tennessee	√						
Texas					√		
Utah	√						
Vermont	√						
Virginia					√		
Washington	√						
West Virginia	√						

DESIGN AND CONSTRUCTION STANDARDS FOR ENSURING HIGH-FRICTION, LOW-NOISE PAVEMENTS (NEW AND RESTORED)

Pavement Friction

Aggregate Properties and Tests

The vast majority of states (41 of 45) indicate that they specify and test for aggregate properties as part of their pavement friction design process. The properties and tests reported range from basic physical features of the aggregate, such as size, gradation, and shape, to the evaluation of durability and soundness to detailed assessment of frictional characteristics.

The tests include an array of national and state standardized procedures, with many of the state tests being modified versions of the following AASHTO and ASTM standards:

- AASHTO T 11 (ASTM C 117)—“Materials Finer Than No. 200 (75 μ m) Sieve in Mineral Aggregates by Washing.”
- AASHTO T 27 (ASTM C 136)—“Sieve Analysis of Fine and Coarse Aggregates.”
- AASHTO TP 58—“Resistance of Coarse Aggregate to Degradation by Abrasion in the Micro-Deval Apparatus.”
- AASHTO T 85 (ASTM C 127)—“Specific Gravity and Absorption of Coarse Aggregate.”
- AASHTO T 96—“Resistance to Degradation of Small-Size Coarse Aggregate by Abrasion and Impact in the Los Angeles Machine.”
- AASHTO T 103—“Soundness of Aggregates by Freezing and Thawing.”
- AASHTO T 104—“Soundness of Aggregate by Use of Sodium Sulfate or Magnesium Sulfate.”
- AASHTO TP 33 / T 304 (ASTM C 1252)—“Uncompacted Void Content of Fine Aggregate (as Influenced by Particle Shape, Surface Texture and Grading).”
- ASTM D 3042—“Acid Insoluble Residue in Carbonate Aggregate.”
- ASTM C 295/C 296: “Petrographic Examination of Aggregates for Concrete.”
- ASTM D 4791—“Flat Particles, Elongated Particles, or Flat and Elongated Particles in Coarse Aggregate.”
- ASTM D 5821—“Percentage of Fractured Particles in Coarse Aggregate.”
- Atterberg limits.
- AASHTO T 89—“Determining the Liquid Limit of Soils.”
- AASHTO T 90—“Plastic Limit and Plasticity Index of Soils.”

Table C-6 provides a breakdown of the number of states that specify and test for those aggregate properties believed to affect pavement friction. The properties include those that are important to other aspects of pavement design, such as mix stability and strength, as well as those specifically related to pavement friction, such as polish value determined via the British Pendulum Tester.

Table C-6. Summary of test properties used in aggregate selection.

Aggregate Property	No. of States
Gradation and Size	8
Angularity, Shape, and Texture	16
Mineral Composition	15
Resistance to Degradation and Abrasion	21
Durability and Soundness	11
Polish and Frictional Characteristics	11

As can be seen, the properties reported by most states were resistance to degradation and abrasion (e.g., LA Abrasion loss), followed by angularity, shape, and texture (e.g., crushed particles, fractured faces, flat and elongated pieces), and mineral composition (e.g., limestone, silica content). Durability and soundness (e.g., sulfate or freeze-thaw soundness) and polish and frictional characteristics (e.g., polish value, acid insoluble residue) also were noted by several states.

Guidelines for Maintaining Pavement Surface Friction

Agencies generally ensure pavement surface friction by specifying pavement surface material (AC or PCC) mix properties or pavement surface texture. A detailed summary of current specifications used by states for pavement surface texture is presented later in this chapter. Summaries of the surface material requirements and finishing specifications are presented in table C-7.

The information in this table shows that agencies typically use a combination of material properties and surface finishing methods to ensure adequate levels pavement surface friction. Material specifications include the use of specific types of AC mixture types, aggregate types, aggregate size, gradation, shape, and aggregate polish value. Finishing requirements are basically specifications for pavement surface texture.

Agency Methods for PCC Finishing/Texturing

For PCC-surfaced pavements, agencies specify pavement surface texture properties to ensure pavement friction. Pavement surface texture specifications reported as part of this survey are summarized in table C-8.

Table C-7. Summary of the surface material requirements and finishing specifications.

Agency	Use of Specific Aggregate Types	Surface Texture Requirements	Aggregate Size, Gradation, Shape	Aggregate Polish Value	Mix Type (for AC)	Use of Additives and Rubber (for AC)	Surface Finishing (for PCC)
Alabama	√		√	√	√	√	√
Alaska							
Arizona			√		√	√	
Arkansas			√	√			√
California			√		√	√	
Colorado	√		√		√		√
Connecticut			√		√		√
Delaware	√	√	√	√	√		√
Florida	√		√	√	√	√	√
Georgia	√		√		√	√	√
Hawaii	√	√					√
Idaho			√		√		√
Illinois					√		√
Indiana	√		√		√		√
Iowa	√	√		√	√		√
Kansas	√		√		√		√
Kentucky	√	√	√	√	√	√	√
Louisiana			√	√	√		√
Maine	√		√	√	√		
Maryland			√	√	√		√
Michigan		√	√	√	√		√
Minnesota		√					√
Mississippi	√		√				√
Missouri					√		√
Montana			√				√
Nebraska							√
Nevada							√
New Hampshire							√
New Jersey		√	√	√	√		√
New Mexico	√	√	√	√	√	√	
New York	√	√	√		√		√
North Carolina	√		√	√	√	√	√
Ohio							√
Oklahoma		√	√		√		√
Oregon							√
Pennsylvania					√		√
Puerto Rico			√	√	√		√
South Carolina	√		√		√	√	√
Tennessee	√		√	√	√		√
Texas				√			√
Utah		√	√	√	√	√	√
Vermont	√		√		√		
Virginia							√
Washington	√	√	√				√
West Virginia			√		√		√

Table C-8. Agency methods for PCC finishing/texturing.

Agency	Texturing Method					
	Tining	Grooving	Burlap	Grinding	Astroturf drag	Sawcutting
Alabama		√	√			
Alaska				√		
Arizona	√					
Arkansas	√		√			
California	√		√	√		
Colorado	√				√	
Connecticut	√	√	√	√		
Delaware	√	√	√	√		
Florida	√					
Georgia	√	√		√		
Hawaii	√	√			√	
Idaho	√					
Illinois	√	√	√	√		
Indiana	√		√			
Iowa	√		√			
Kansas	√		√	√		
Kentucky	√		√	√		
Louisiana	√		√	√		
Maine ^a						
Maryland	√	√	√			
Michigan	√	√	√	√		
Minnesota					√	
Mississippi	√					
Missouri	√		√	√		
Montana	√		√			
Nebraska	√					
Nevada	√	√		√		
New Hampshire	√	√				
New Jersey				√		√
New Mexico		√		√		
New York	√	√		√	√	
North Carolina	√					
Ohio	√					
Oklahoma	√					
Oregon	√					
Pennsylvania	√			√		
Puerto Rico	√	√		√		
South Carolina	√			√		
Tennessee	√		√	√		
Texas	√					
Utah	√					
Vermont ^a						
Virginia	√	√	√			
Washington	√					
West Virginia		√				

^a State does not pave with PCC.

This table shows that 37 of the 45 agencies specify tining as a finishing method for new PCC surfaces. Twenty-one states specify burlap or Astroturf drag techniques, mostly in conjunction with tining, while 25 states use grooving or grinding on either new or existing PCC pavement.

Twenty-six of the 37 agencies that require tining, specify that it be done transversely (i.e., perpendicular to centerline), whereas six states—Arizona, California, Colorado, Florida, Nebraska, and Nevada—specify longitudinal tining. Iowa and New York allow both longitudinal and transverse tining, while Virginia allows transverse and crisscross (transverse and longitudinal combined) tining.

Dimensions of tining grooves range primarily from 0.08 to 0.25 in (2 to 6 mm) deep and 0.06 to 0.125 in (1.5 to 3 mm) wide, and the spacing of the grooves range from 0.5 to 1.0 in (12 to 25 mm). Randomly spaced grooves typically vary from 0.25 to 1.5 in (6 to 38 mm).

Agency Practices Concerning Triggers for Friction Restoration

Highway agencies take varied approaches toward identifying friction deficiencies and establishing solutions for restoring friction. Some agencies, such as New Hampshire and Vermont, do not monitor friction levels but periodically examine crash rates and/or certain distress types (e.g., rutting, drainage issues) that might warrant friction-related treatments. Some states perform friction testing in response to requests from Districts or other departments concerned with higher-than-normal crash rates. For instance, the Ohio DOT evaluates pavements on a site-by-site basis as identified by District, Project, or Construction Engineers, or by wet crash data.

The most common approach of determining friction deficiency involves a combination of network-level friction monitoring and crash rate evaluation. In this approach, the statewide system of highways is tested for friction on a 1-, 2-, or 3-year basis and the results are reviewed to identify any potentially deficient locations. Such locations are generally flagged using a specific trigger friction value, and those locations are then cross-checked with crash data simultaneously maintained and analyzed. Depending on the results, the agency may choose a variety of responses, from doing nothing to conducting an on-site evaluation of the subject location to taking preliminary safety precautions (e.g., erecting signs, initiating plans for treatment in the future) to enacting immediate safety measures (e.g., restoration treatment).

Although some states use their trigger friction value as a means of initiating some sort of restoration treatment, many use it to prompt a detailed project-level investigation of friction. Nevertheless, it is of some interest to examine the trigger values that are used and the nature of the friction index used. Table C-9 provides a summary of the trigger friction values reported in the state surveys.

Table C-9. Trigger values used in identifying potential friction-deficient locations.

Friction Value	Number of States		
	Ribbed-Tire Friction Number (FNR)	Smooth-Tire Friction Number (FNS)	Highway Friction Tester (HFT)
<37	2		
<35	5	1	1
<32	1		
<30	6		
<25	1		
≤20		3	

Techniques Used to Maintain Friction

The treatments that agencies use to restore pavement surface friction are summarized in table C-10. As can be seen, the most common treatments consist of thin AC overlays, PCC grinding, and micro-surfacing. Other types of treatments reportedly used include chip seals and PCC surface retexturing, in the form of shot-blasting or grooving.

Pavement–Tire Noise

Pavement–Tire Noise Considerations in AC- and PCC-Surfaced Pavement Design

Only 10 of the 45 responding states directly consider the effect of pavement–tire noise in the design of AC-surfaced pavements—Arizona, Colorado, Kentucky, Michigan, Nevada, New Jersey, New Mexico, Oregon, Texas, and Utah. Among these states, open-graded asphalt, stone matrix asphalt (SMA), and rubberized asphalt mixes are most commonly used to reduce pavement–tire noise.

As seen in table C-11, 16 of the 45 responding agencies consider the effects of noise when specifying surface texture for PCC pavements. The most common forms of texturing for noise reduction include random tining, diamond grinding, and longitudinal tining.

Table C-10. Summary of treatments used to restore pavement surface friction.

Agency	Treatment Types							
	Grinding	Thin Overlays	Micro-surfacing	Shotblasting	Grooving	Milling	Scarifying	Chip Seals
Alabama	√	√	√					
Alaska								
Arizona	√	√		√	√			
Arkansas		√	√ ^b					
California	√	√						
Colorado	√	√	√					√ ^a
Connecticut	√	√		√				
Delaware								
Florida	√							
Georgia	√	√	√					
Hawaii	√							
Idaho	√	√	√					
Illinois		√	√		√			
Indiana	√	√	√					
Iowa	√	√						
Kansas	√		√					
Kentucky	√	√						
Louisiana	√	√	√					
Maine	√	√	√					
Maryland	√	√	√					
Michigan	√	√	√				√	√
Minnesota	√	√	√					
Mississippi	√	√	√	√	√	√		
Missouri	√	√	√					
Montana								√
Nebraska	√ ^b							
Nevada	√	√						
New Hampshire		√						
New Jersey	√	√	√					
New Mexico	√	√	√					
New York	√	√	√					
North Carolina	√	√	√					
Ohio	√	√	√					
Oklahoma	√	√	√					√
Oregon	√	√						
Pennsylvania	√	√	√			√		
Puerto Rico	√	√						
South Carolina	√							
Tennessee	√ ^b	√	√					
Texas	√ ^b	√	√					
Utah	√	√	√					√
Vermont		√	√					
Virginia		√	√					
Washington								
West Virginia		√						

^a Chip seals on low-volume roadways.

^b Others reported, but not specified.

Table C-11. Textures specified for noise in PCC design.

Agency	Finishing Method					Notes	
	Random Tining	Burlap Drag	Grooving	Grinding	Long. Tining		Astroturf Drag
Alabama							None.
Alaska							None.
Arizona							Other: Open-graded AC mix
Arkansas							None.
California							None.
Colorado					√	√	Astroturf drag for posted speeds<45 mi/hr (<72 km/hr).
Connecticut							None.
Delaware							None.
Florida							None.
Georgia							None.
Hawaii	√						
Idaho							None.
Illinois							None.
Indiana							None.
Iowa	√			√	√		
Kansas	√				√		
Kentucky		√		√			
Louisiana							None.
Maine							None.
Maryland							None.
Michigan	√	√		√			Grinding as mitigation.
Minnesota						√	
Mississippi							None.
Missouri							None.
Montana							None.
Nebraska							None.
Nevada			√				
New Hampshire							None.
New Jersey				√			
New Mexico				√			
New York				√			
North Carolina	√			√			
Ohio							None.
Oklahoma							None.
Oregon	√						
Pennsylvania							None.
Puerto Rico				√			
South Carolina							None.
Tennessee							None.
Texas	√						
Utah	√						
Vermont							Not applicable.
Virginia							None.
Washington							None.
West Virginia							None.

SAFETY AND LEGAL ISSUES RELATED TO FRICTION/TEXTURE AND CRASH RATES

Agency Practices Relating Friction to Crashes

Although several states compare wet-weather crash rates with friction test results to determine if a site needs remedial action, only a few have investigated the relationship on a broad scale. Texas and North Carolina reported finding no direct correlation between friction and crashes. Arizona noted that, “research by others has indicated a friction value of 35 reflects accident breakpoint.” California noted that “a CALTRANS study found that there was a relationship between FN<25 and a high frequency of accidents.”

APPENDIX D
SUMMARY OF STATE AND INDUSTRY INTERVIEWS

INTRODUCTION

This appendix provides a summary of the results of interviews with selected states and industry organizations, supplemented with pertinent information from the project literature. It provides additional information (in addition to the findings of the state friction survey) regarding current and near-future practices, ideas, and issues related to friction, including economic factors.

This summary is based on information obtained from representatives of state departments of transportation (DOTs), industry organizations, and experts or practitioners in the pavement surface characteristics field. It is organized to address the following important aspects of pavement friction:

- Friction management.
- Friction testing.
- Determining friction demand.
- Pavement surface selection and design.
- Pavement construction.
- Economic considerations.
- Noise-related issues.
- Suggested improvements to friction practices and desired areas of friction guidance.

One or more representatives were contacted and interviewed at the following state DOTs:

Agencies

- Arizona (ADOT).
- California (CALTRANS).
- Florida (FDOT).
- Georgia (GDOT).
- Illinois (IDOT).
- Louisiana (LADOTD).
- Michigan (MDOT).
- New York (NYSDOT).
- Texas (TXDOT).
- Virginia (VDOT).
- Washington State (WSDOT).

Representatives of paving associations, truck manufacturers, tire manufacturers, equipment manufacturers, and others were also contacted and interviewed. These included representatives from the following organizations:

- American Concrete Pavement Association (ACPA).
- National Asphalt Pavement Association (NAPA).
- California Chip Seal Association (CCSA).

- Rubber Manufacturers Association (RMA).
- International Grinding and Grooving Association (IGGA).
- Mack Trucks.
- Kenworth Truck Company.
- Volvo North America Group.
- International Cybernetics Corporation.
- Dynatest Consulting.
- Texas Transportation Institute (TTI).
- Transportation Research Center (TRC).
- N.V. Robuco of Belgium.

FRICION MANAGEMENT PRACTICES

The interviewed states currently take more of a monitoring approach to pavement friction than a design approach. In other words, they generally put more emphasis on routinely evaluating friction levels and crash rates and reacting to deficiencies than on designing pavements to satisfy friction demands.

Although there may be several reasons for this tendency, the type and quality of aggregates available for use is often a factor. In some states, such as Georgia, New Hampshire, and Washington, where good quality aggregates are largely available, the need to design mixes for friction is less of a priority because of the good performance provided by the aggregates. In states such as Florida, Louisiana, and Texas, where lower quality aggregates are more common, friction design generally is an integral part of the overall friction management program.

Each of the interviewed states, as required by law, maintains a crash database and makes use of the data in identifying pavements with potential friction deficiencies. Various methodologies are used in analyzing crash data, and the results of such analyses are used in different ways. For instance, in Arizona, both high crash rates and low friction numbers can serve as triggers for special investigation, whereas in Illinois, the identification of high wet-weather crash rates by a district is usually a prompt for friction testing by the central office.

FRICION TESTING PRACTICES

As reported in appendix C, the NCHRP Project 1-43 survey of states established that nearly all agencies use an ASTM E 274 locked-wheel friction testing device for pavement friction management and evaluation. Fifty-six percent of reporting agencies use the ASTM E 501 ribbed tire exclusively, and 15 percent use the ASTM E 542 smooth tire exclusively. The remaining agencies use a combination of tires for management and crash investigation.

The quality of ASTM E 274 data collection is in large part controlled by the maintenance of the equipment, the training and dedication of the operator, and the adequacy of calibration activities. Manufacturers of locked-wheel friction testers indicate that data quality is most affected by the training, experience, and attention to detail of the equipment operators (Olinoski, 2004; Beck, 2004). They note maintenance problems such as tire and brake pad

wear can affect data quality. Infrequent or improper calibration activities are considered as more typical inhibitors to good data quality. They emphasize daily checks as well as monthly and regular calibration at the Texas Transportation Institute (TTI) or the Transportation Research Center (TRC) calibration facilities. Because of reported nozzle clogging, TTI suggested monitoring water flow as a method to ensure adequate water supply and accurate friction numbers (Zimmer, 2004).

ASTM E 274 equipment manufacturers are providing laser texture measuring equipment and software for requesting agencies. At least four ASTM E 274 trailers with texture measurement capability have been delivered to agencies in the U.S. by March 2004 (Olinoski, 2004; Beck, 2004). Calibration checks for the texture lasers are as critical as calibration checks for the locked wheel measuring systems. Currently, equipment manufacturers are recommending that texture lasers be calibrated in a manner similar to those used for standard smoothness profiling. However, they recognize a need for better confirmation of measurement accuracy and are considering additional calibration methods for mean profile depth (MPD) data collection.

The design of friction testing equipment can also affect friction number (FN) accuracy and repeatability. Reported recent equipment upgrades intended to improve data quality include moving the signal digitization to the trailer from the driver's position to reduce analog signal distortion from long cables. Optical distance measuring wheel encoders have also been installed to replace potentially incorrect servo tachometers. Manufacturers tend to avoid torque tubes, which have limited ability to account for vehicle dynamics in the vertical load.

In addition to adding texture measurement capability, other changes are on the near horizon for ASTM E 274 equipment. Improvements being considered include adding the ability to measure locked-wheel friction in increments of distance as well as time. This is a topic of discussion for the ASTM E-17 committee and will allow better correlations between friction measurements at different speeds. Global positioning equipment may also be integrated.

Manufacturers recommend daily and regular calibration of ASTM E 274 equipment to maintain data quality. Two national ASTM E 274 calibration centers also provide rigorous equipment calibration testing that agencies typically complete every 2 to 3 years. TTI and TRC provide ASTM E 274 locked-wheel tester calibration services for about \$11,000 per unit (Zimmer, 2004; Lyon 2004). This service provides static and dynamic calibration testing according to ASTM E 1890 using 108 runs on three calibration pads. Comparison with the TTI standard equipment allows agencies to inter-correlate their equipment output and compare their friction numbers with those of other agencies. Neither TTI nor TRC has developed methods for checking the calibration of laser texture measuring equipment.

PAVEMENT SURFACE SELECTION

Selecting pavement types and materials to meet frictional and noise needs reasonably requires estimating the frictional "demand" of a pavement. This "demand" is difficult to define but can be estimated as a function of traffic levels, climatic conditions, required maneuvers (braking, turning, accelerating, steady state), vehicle types (percent trucks), and

other factors. Very few agencies reportedly have developed a methodology for estimating the friction “demand” of a pavement. Texas and Maryland are among the first. The first step in the Texas Wet Weather Accident Reduction Program (WWARP) is to determine the overall frictional demand on a road surface (Stampley, 2004). This is accomplished by rating the demand as low, medium, or high based on the factors and levels shown in table D-1. These factors are grouped as either (A) general attributes or (B) parameters set by the designer. Recommendations are also given regarding which factors are more critical; however, the overall rating remains slightly subjective.

Table D-1. Texas WWARP friction demand classification.

Factor	Attribute	Low	Moderate	High
A	Rainfall, in/yr	≤ 20	$>20 \leq 40$	> 40
A	Traffic, ADT	≤ 5000	$>5000 \leq 15,000$	$> 15,000$
A	Speed, mi/hr	≤ 35	$>35 \leq 60$	> 60
A	Percent Trucks	≤ 8	$>8 \leq 15$	> 15
A	Vertical grade, %	≤ 2	$>2 \leq 5$	> 5
A	Horizontal curve, deg.	≤ 3	$>3 \leq 7$	> 7
A	Driveways per mi	≤ 5	$>5 \leq 10$	> 10
A	Intersecting Roadway ADT	≤ 500	$>500 \leq 750$	> 750
B	Cross slope, in/ft	0.375 – 0.5	0.25 – 0.375	≤ 0.25
B	Design life, yr	≤ 3	$>3 \leq 7$	> 7
B	Proposed macro-texture	Coarse	Medium	Fine

1 in = 25.4 mm

1 mi = 1.61 km/hr

1 mi/hr = 1.61 km/hr

1 in/ft = 0.083 m/m

The Maryland DOT differentiates friction demand on straight segments and curves. For straight segments, five demand categories are selected according to the descriptions in table D-2. Additional differentiation is given in regard to mean speed and the percentage of trucks expected on the roadway. Guidelines for side friction factor requirements for curves are ranked according to driving complexity and curve radius, as shown in table D-3. They provide additional differentiation in regard to average speed and super-elevation.

Table D-2. Maryland DOT straight segment friction demand classification.

Site/Demand Category	Site Description
1 (high)	Approach railroad crossing, traffic lights, pedestrian crossing, stop and give way controlled intersections
2 (medium to high)	Curves with radius < 820 ft (250 m), downhill gradient > 10 percent, and > 164 ft (50 m) highway on/off ramp
3 (medium)	Approach to intersections, downhill gradient 5 to 10 percent
4 (low to medium)	Undivided highways without any other geometrical constraints which influences friction demand
5 (low)	Divided highways without any other geometrical constraints which influences friction demand

Table D-3. Maryland DOT curved segment friction demand classification.

Driving Complexity*	Radius, ft (m)
High (UR =1)	328 (100)
	820 (250)
Critical (UR =0.875)	328 (100)
	820 (250)
Considerable risk (UR =0.675)	328 (100)
	820 (250)
Very dangerous (UR =0.5)	328 (100)
	820 (250)

*High = high safety standard required, critical = critical driving maneuvers possible, considerable risk = considerable crash risk exists, very dangerous = very dangerous, high crash risk.

The New York DOT is currently researching the relationship between vehicle energy input (maneuvers), friction needs, and aggregate properties for use in defining friction “demand” (Skerritt, 2004). Other highway agencies specify their aggregate and texture properties based on traffic levels. For example, Illinois requires turf drag and transverse tining at 20-mm (075-in) spacing for roads with posted speeds in excess of 65 km/hr (40 mph). For lower speed roads, the finish can be turf drag with or without transverse tining (Rowdan, 2004).

PAVEMENT SURFACE FRICTIONAL DESIGN

Asphalt Concrete Design

Designing asphalt concrete (AC) pavements to meet frictional “demand” requires selecting mix designs and aggregate types and properties that can adequately provide long-term friction. Commonly, agency frictional design programs attempt primarily to control the micro-texture properties of the course aggregate. Aggregate types are differentiated and selected by carbonate content (e.g., limestone), British Pendulum Test/Polish Value (AASHTO T 278), magnesium phosphate soundness (AASHTO T 104), LA Abrasion (ASTM C 131), crushed particle ratio (ASTM D 5821), and others. Some agencies with polish-resistant aggregate achieve good frictional performance regularly and have not been required to significantly test their aggregates for frictional properties (Geary, 2004; Pierce, 2004). Other agencies must use available limestone or dolomite aggregates or pay large shipping fees. These agencies, in particular, are working to implement aggregate tests that will ensure good frictional performance.

The Texas DOT has developed an aggregate rating system that classifies coarse aggregate source materials into four categories (A, B, C, and D) to match their demand classifications. These ratings are updated semi-annually based on aggregate properties from approved resources (TXDOT 2004). Source aggregates are rated according to polish value, LA Abrasion, and magnesium phosphate soundness for hot mix asphalt concrete and surface treatment applications. Suggestions for blending are also provided. Testing of the aggregate used in construction is completed to verify the classification, and post-construction frictional testing is conducted to ensure adequate friction levels.

For selecting AC paving materials to best correlate with field performance, agency laboratory testing must evaluate short- and long-term micro-texture and macro-texture. The Michigan DOT has attempted to measure the overall friction properties (micro-texture- and macro-texture-related) of their coarse aggregates by running full-size tires on a large-scale track with embedded samples of uniformly graded aggregate. They then apply a scale version of a towed friction trailer to the worn surface to measure an Average Wear Index (AWI) representative of changes in frictional resistance with polishing. Shortcomings of this approach are the inclusion of only the coarse aggregate and the cost of the equipment and testing. The first limitation is evident in the variability between AWI ratings and field friction numbers (McDaniel, 2004).

Another more comprehensive approach recently developed by the National Center for Asphalt Testing (NCAT) includes a combination of a circular track polishing machine, a Dynamic Friction Tester (DFT), and a Circular Texture Meter (CTM). The NCAT polishing machine uses three tires on a circular track of the same diameter as the CTM and DFT 11.2 in [284 mm]) (Nippo Sangyo, 2004). The device allows for lowered costs and full measurement of the polished surface. Using the DFT and CTM results, the International Friction Index (IFI) measurement can be obtained. This approach has been reviewed by the McDaniel of the Institute for Safe, Quiet, and Durable Highways (ISQDH) and is proposed for use in full-scale field comparisons to be completed by December 2004. The planned experimental matrix includes three gradations, two nominal maximum aggregate sizes, five aggregates, and three friction aggregate contents (McDaniel, 2004).

Portland Cement Concrete Design

Designing portland cement concrete (PCC) pavements for good frictional characteristics primarily requires selecting adequate surface texturing methods and secondarily requires selecting adequate aggregate properties. The PCC texturing properties used by state agencies indicate a sustained reliance on tining for producing macro-texture in PCC pavement surfaces. Further review of available agency specifications indicates a significant use of longitudinal tining, as table D-4 shows. The wide variety of random transverse spacing designs indicates that agencies are not regularly following the recommendations of the Wisconsin randomization study, although the reason is not defined. By far, the most common method of PCC tining includes transverse tining using 0.5-in (13-mm) spacing. Georgia DOT indicates that they have not had pavement-tire noise problems using this method (Geary, 2004).

Table D-4. Standard specified PCC surface tining methods.

Tining method	Tine spacing, in (mm)	Agency
Transverse uniform	0.5 (13)	AK, CN, DE, GA, MI, MO, MS, SC
	0.75 (19)	AK, IL, IA, MT, NY, VA
	1.0 (25)	TX
Transverse random	Max. 0.5 (13)	ID
	Max. 0.75 (19)	HI
	0.19 – 1.25 (5 – 32)	IN
	0.3 – 1.0 (8 – 25)	TN
	0.375 – 1.5 (10 – 38)	LA
	0.375 – 1.625 (10 – 41)	IA
	0.375 – 1.75 (10 – 44)	OH
	0.5 – 0.75 (13 – 19)	NC
	0.5 – 1.0 (13 – 25)	FL, OK
	0.5 – 1.25 (12 – 32)	OR, WA
	0.625 – 0.875 (16 – 22)	MD, UT
0.875 – 1.25 (22 – 32)	NJ	
Longitudinal uniform	0.75 (19)	AZ, CA, CO, NE, NV, NY
Longitudinal random	0.5 – 1.0 (13 – 25)	FL

Other PCC texturing methods, used regularly in Europe, include Exposed Aggregate Cement Concrete (EACC) and Enhanced Porosity Concrete (EPC). Recently a 10.3-mi (16.6-km) section of the E40/A10 freeway from Brussels to Belgium carrying 57,000 ADT was paved using EACC and a stringless paver (Gomaco, 2004). Mr. Romain Buys of NV Robuco in Belgium indicates that the Austrian Cement Association has 8 to 9 years of experience with large-scale two-layer porous PCC construction. The layers are placed wet using a single modified paver. Aggregates used in the lower layer are typically PCC recycled from the original pavement, and the upper 1.4 in (35 mm) layer is designed using open graded quartzite aggregate (Buys, 2004).

Other Surface Property Factors

Other surface property factors that need to be accounted for in designing pavements are pavement-tire noise, splash and spray, hydroplaning, and rolling resistance. Tire wear and glare also can be considered. Noise issues are discussed in a later section.

Splash and Spray

Splash and spray thrown against windshields by passing vehicles are a potential hazard in that these impair visibility, especially at night. However, the safety hazard created by splash and spray has not been precisely defined. The percentage of wet weather crashes directly attributed to splash and spray ranges from 1 to 10 percent (ISPA, 1977; Sabey, 1973).

Splash is defined as the large droplets of water that are thrown off the tire or squeezed out from the pavement-tire contact area. Splash is associated with "large" water depths or low vehicle speeds. Spray is the mist that is carried alongside and thrown behind a vehicle by the turbulent airflow created by a moving vehicle. It is associated with shallow water depths or high vehicle speeds. Increasing macro-texture decreases splash and spray intensity and duration, thus improving safety through better visibility (Pilkington, 1982).

As a vehicle travels through water on the pavement, the water is splashed both outward and inward from the rolling tires. It is also thrown forcefully backward by the front tires into the following tires and the vehicle's surfaces, where it is broken into smaller droplets. These smaller droplets are more easily affected by air turbulence and wind. The droplets, together with water blown and vacuumed off the road and vehicle surfaces by fast-moving vehicles, contribute to spray (WHI, 1973; Wambold et al., 1984).

As water falls or runs onto a pavement, a certain initial amount is required to fill the pavement surface texture before runoff occurs. This is known as depression storage. When the surface voids are filled, runoff begins and increases to a constant value. The thin sheet of water on the surface at this time, excluding depression storage, is known as surface detention (Galloway, 1975). Besides reducing traction, surface retention contributes to splash. After runoff ceases, depression storage produces spray. This effect is longer lasting and causes poor visibility because of windshield splatter.

Various techniques have been used for measuring splash and spray. Quantitative measuring instruments include densitometers, photometers, spraymeters, and spray collectors (Ritter, 1974). Photographs of a test vehicle, as it travels through a wet test course, can be front, side, oblique, or rear views, and the spray density can be evaluated subjectively by examining the pictures.

The principal factors contributing to splash and spray are water, air, the driver, the vehicle, speed, the highway geometry, and the texture (WHI, 1973; Wambold et al., 1984). The water factor includes rain, snow, slush, mud, and muddy water. The form of the moisture, the amount, and its location on the highway are also important.

To reduce pavement water depths and drainage times, the following design, construction, and maintenance standards have been proposed (WHI, 1973; Wambold et al., 1984):

- Increase cross slopes.
- Reduce the number and length of zero grades by alternating slight plus and minus gradients.
- Eliminate shoulders that tend to prevent water drainage.
- Construct lateral grooving rather than longitudinal grooving.
- Slope multilane divided highways away from the median.
- Avoid excessively smooth surfaces, especially those with flat cross slopes.
- Keep shoulders and outside pavement edges free of ice, snow, and slush.

Macro-texture is more important than micro-texture in minimizing splash and spray, because it promotes water drainage (Bonds et al., 1974). Open-graded asphalt pavements generally are better than either PCC or dense-graded AC pavements in allowing surface water to drain because of their more desirable macro-texture. Pavements designed to reduce hydroplaning will also reduce splash and spray. Procedures have been published for both U.S. (ISPA, 1977; Gallaway et al., 1975; FHWA, 1973a; FHWA 1973b; NCHRP, 1974; NCHRP, 1978) and European (Cram, 1975; Sorenson et al., 1974) open-graded pavement designs that optimize water- drainage characteristics.

Although open-graded AC pavements have a macro-texture that permits surface water to drain easily, they may also have some drawbacks (WHI, 1973; Wambold et al., 1984):

- Load-carrying ability is less.
- Dirt and oil can clog the voids and reduce drainage ability.
- Voids can be sealed off by bleeding due to compaction under load.
- Bases and sub-bases can become contaminated, thereby structural stability.
- Subgrades can swell, heave, and creep, thus deforming breaking up pavement and base structures.
- Water freezing in any structural layer can result in the entire roadway structure.

Hydroplaning

An important non-friction-related effect of pavement surface texture is its role in the prevention of hydroplaning. There are two highway-related forms of hydroplaning: dynamic hydroplaning and viscous hydroplaning. Pavement surface macro-texture texture plays an important role in the prevention of each.

Dynamic hydroplaning occurs when the vehicle tire loses contact with a flooded pavement and rides on a layer of water. Macro-texture influences dynamic hydroplaning in two ways: it has a direct effect on the critical hydroplaning speed because it provides a pathway for water to escape from the pavement–tire interface, and it has an indirect effect on the critical hydroplaning speed through its effect on the water depth on the pavements (the larger the texture, the deeper the water must be to cover it). In both cases, increases in macro-texture depth tend to increase the critical hydroplaning speed. However, the road must also have the proper micro-texture to develop friction.

Viscous hydroplaning occurs when a thin film of water remains between the tire and the pavement with insufficient micro-texture to break through the film. Micro-texture prevents viscous hydroplaning because the small asperities penetrate the water film and allow semidry contact of the pavement with the tire.

Excessive amount of water on the pavement surface causing hydroplaning can be reduced through design the pavement surface characteristics. Several factors influence the water film thickness on a pavement surface and thus the potential for hydroplaning. Identified factors include:

- Pavement (micro-texture, macro-texture, cross-slope, grade, width, curvature, and longitudinal depressions).
- Environmental (rainfall intensity and duration).
- Driver factors (speed, acceleration, braking, and steering).
- Vehicle (tire tread wear, ratio of tire load to inflation pressure, vehicle type).

Rolling Resistance and Fuel Consumption

Pavement surface texture has a small but potentially important influence on the fuel consumption of vehicles on the highway. Pavements with high levels of micro-texture and macro-texture cause some increase in fuel consumption. Fuel consumption can increase by as much as 10 percent, although the typical difference is much smaller (less than 2.0 percent). The exact relationship between pavement surface texture and fuel consumption has not been determined. However, an estimate of the influence can be inferred from independent relationships between pavement surface texture and tire rolling resistance and between tire rolling resistance and fuel consumption. Members of the trucking industry are particularly concerned that pavement designs optimize friction and rolling resistance properties (Yeakel, 2004).

Tire and Pavement Wear

Pavement–tire interactions cause wear of both the tire and the pavement. Wear rates of each are influenced by the texture of the pavement; however, wear is very slow and is affected by many other factors. For this reason, only minimal data have been obtained that document the texture effect; the conclusions drawn are largely qualitative.

Traction on dry pavement is a function of grip and friction, both of which improve with an increased density of asperities in the micro-texture range. Generally, this same texture also leads to more rapid tire wear. Macro-texture is a relatively unimportant factor with regard to tire wear or traction, although increased macro-texture can cause more wear through rubber reversion (during skidding) and can result in reduced grip, both effects being disadvantageous.

In general, dense-graded pavements (low macro-texture) appear to be more wear-resistant than open-graded pavements (high macro-texture). Uniformly macro-textured surfaces, such as those created by fluted float, rotating drum, or grooving processes, wear at a slower

rate than irregularly macro-textured surfaces created by such processes as burlap dragging and brooming.

Glare, Light Reflection, and Night Visibility

Work in the 1950s on the reflection characteristics of dry pavements determined that highly bright and specular (mirror-like) surfaces were best for high angle lighting. However, these pavements were unacceptable because of their slipperiness. Lighting under wet conditions is complex, and only very limited information exists regarding these properties. There has been some European research; however, and extensive work was reported in a Danish document (Sorenson, 1974).

Increasing texture reduces pavement luminance, which in turn reduces the visibility of lighted roads. Increasing texture also provides better water drainage, thereby reducing glare for wet pavements. Retro reflection, light from headlights reflected back toward the driver, increases with macro-texture depth until the macro-texture peaks shadow one another. Night visibility of painted pavement markings is enhanced by macro-texture depth because the paint in the voids is protected from wear.

Diamond Grinding

Diamond grinding has been used in new and rehabilitation designs for PCC pavements to improve ride quality and reduce pavement-tire noise. Properly designing PCC grinding operations also requires research and understanding of aggregate properties and grinding techniques. On-going and previous research indicates that blade spacing of PCC grinding equipment is critical to both noise and smoothness (Roberts, 2004; Buys, 2004). Typically, narrower grinder blade spacing gives smoother pavements and faster wear, but wider spacing results in less pavement-tire noise and extended skid resistance. Practically, harder aggregates require more narrow spacing, due to the “unbroken aggregate fins” that form with wider spacing. Design blade spacing should be selected according to aggregate hardness to optimize “fin” breakoff. A Belgian contractor uses a device that evenly breaks off “fins,” allowing for wider spacing and less pavement-tire noise (Buys, 2004). Reportedly, Iowa has a specification for blade spacing as a function of aggregate hardness. South Dakota is doing research to develop such a specification, and a Belgian contractor has developed a similar relationship for European aggregates (Roberts, 2004; Buys, 2004).

Microsurfacing

Agencies describe using properly designed microsurfacing as fast, but sometimes expensive, methods for restoring pavement friction. The CCSA recommends setting limits on aggregate types for chip seals to avoid early wear, using only crushed aggregate, and avoiding sandstone. They also recommend allowing no more than 25 percent loss on the LA Abrasion test for chip seal and microsurface aggregate (Metcalf, 2004).

PAVEMENT CONSTRUCTION

The methods and equipment used in constructing and rehabilitating AC and PCC pavements can also affect a pavement's short- and long-term friction and noise properties. As an example, field experience has shown that higher friction, on the order of 5 friction points, can be achieved by operating the hot mix asphalt (HMA) laydown machine in the direction of vehicle traffic. Similarly, the type of compaction equipment and rolling patterns can influence the surface friction (i.e., rubber-tired rolling versus steel-wheeled rolling). The manner of construction of friction restoration treatments, such as chip seals, slurry seals, microsurfacing, and proprietary surfaces (e.g., NovaChip®, ItalGrip), are all susceptible to providing less than expected friction if poor construction practices are employed.

Spacing of the diamond blades in grinding machines many times can be optimized during construction to achieve the best noise, smoothness, and long-term friction properties.

ECONOMIC CONSIDERATIONS

There are several economic aspects or considerations associated with improving pavement friction and friction-related characteristics. These considerations center around the costs and benefits of (a) managing pavement friction for safety, and (b) selecting, designing, and constructing surfacings for new pavement structures and restoration treatments for existing pavements.

The economic considerations of friction and friction-related items can take the form of direct agency costs/benefits or indirect costs/benefits accrued by highway users. Moreover, economic impacts can take place at the network level or the project level. Detailed discussions of these considerations, based on the latest available literature and recent interviews with selected state agencies and industry organizations, are presented below.

Pavement Friction Management

As indicated earlier, state agencies take varied approaches to ensuring the adequacy of friction on their highways. The approaches range from a simple evaluation of crash rates with no or limited consideration of friction in design to an elaborate process involving network-level friction testing, detailed crash analysis, and friction performance-based design strategies.

Naturally, program costs vary widely, as they depend on the amount of personnel and resources (computer hardware and software, laboratory equipment) needed to develop, implement, and operate each component of the program. As an example, the Florida DOT has estimated costs of \$250,000 to develop and implement their friction database, \$2,000/year for database software maintenance, and over \$1 million/year for data collection and input (Brady, 2004). Costs for California's friction data collection and processing have been roughly estimated at \$350,000/year, derived using assumptions regarding the size of the highway inventory tested, the number of friction test operators and their labor rates, testing productivity, and equipment maintenance and depreciation costs (Vacura, 2004).

The benefits of such programs can be examined in terms of the number of crashes and/or crash-related costs (fatalities, injuries, vehicle and property damage), or in terms of the friction-related litigation costs experienced by the agency. By comparing the overall benefits and costs associated with expanding or cutting back certain components of a friction program, agencies can make more informed decisions regarding the appropriate size and scope of their program. A further extension of this type of analysis involves the use of risk management principles and procedures.

Selection, Design, and Construction of Pavement Surfacing and Restoration Treatments

The process of selecting, designing, and constructing surfacings for new pavements and restoration treatments for existing pavements provides many opportunities for economizing highway pavement projects. This is because there are numerous materials, mixes, and construction techniques that form an array of pavement textures that generate a wide variety of surface friction, noise, drainage properties (i.e., splash/spray, hydroplaning). Moreover, under the loading applications of traffic and environment over time, these surfacings and treatments exhibit different texture wear characteristics, which impact their ability to meet the required or desired levels of friction, noise, and drainage.

Because the mix/material types have varying costs and may perform differently over time, their overall life cycle costs can be substantially different. These agency cost differences can be further impacted by the inclusion of user costs associated with normal operating conditions (i.e., crash, time delay, and vehicle operating costs resulting from deficient friction, noise, and/or drainage) and the timing of future work zones (i.e., if one mix/material type fails functionally before another).

Provided in the sections below are summaries of how economics factor into the friction design and management of asphalt and concrete pavements, respectively. The summaries are based on detailed reviews of compiled literature, as well as informative discussions with various state agency representatives.

Asphalt Surfacing Mixes and Restoration Treatments

The economic considerations for asphalt surfacings and treatments center around the type, quality, and gradation of aggregate used in the mix/material (coarse and fine dense-graded AC, OGFC, SMA, microsurfacing, chip seals, specialty surface treatments [Novachip[®], Italgrip]) and, to a lesser extent, the type of asphalt binder (conventional, SuperPave, PMA, RA) used. The economic consequence of using alternative mixes/materials requires the acquisition and analysis of up-to-date unit bid prices and pertinent forms of time-series performance data (e.g., distress, ride, friction, noise). Information concerning construction time requirements and other construction-related issues (e.g., production, placement, finishing, lab and field testing) is also important.

Although the compiled literature contained documents focusing on the performance characteristics of different asphalt mixes, only a few included information on the associated costs and/or economic impacts of the mixes. Fewer still focused specifically on friction and friction-related performance.

Studies done by the Oregon DOT (Hunt, 2002) and Florida DOT (Choubane et al., 1999), for example, looked at the performance and costs of different asphalt surface mixes (in Oregon, wet- and dry-processed rubber-modified mixes [dense- and open-graded]; in Florida, conventional and rubber-modified dense- and open-graded mixes). However, while friction performance was evaluated in both studies, structural and ride performance were the primary bases for determining the cost-effectiveness of the mixes.

Perhaps the most pertinent study found in the literature was one done by the Maryland SHA (Chelliah, 2003). As part of a research effort begun in 2002 to develop a design policy to improve pavement surface characteristics, the Department performed and illustrated an example benefit/cost analysis comparing pavements designed and built at two different friction levels (FN=45 and 35). Using their own crash prediction model and crash cost statistics (for fatalities, injuries, and property damage), as well as estimates of performance and construction costs, a benefit/cost ratio of nearly 7 was determined, showing the economic advantage of using a pavement surface with higher friction. The study noted that using mixes with aggregates having polish values of 7 or higher may require importing aggregates from outside the region. However, when the cost of wet crashes is compared to the initial cost outlay of importing aggregates, the latter will be a much more economical option.

Maryland's research into friction design resulted in the adoption of an economically based design policy to minimize future wet-surface crashes. The policy entails the following:

- Check if wet-weather problem exists.
- Select target design friction level.
- Predict potential reduction in wet crashes.
- Calculate benefit/cost ratio of design target.
- Evaluate effectiveness of design.
- Select surface mix with adequate polish value.

Interviews with selected state agencies did not reveal any specific studies involving the economic impacts of AC friction design and management. However, several points of interest were brought up in the discussions. Illinois, for example, described how its recent move to higher blend aggregates had an economic component to it, in that more locally available aggregates are now used, which provide comparable friction performance at a lower cost (Rowden, 2004). Michigan discussed its need last year to revise its asphalt specifications to include aggregate wear index testing for Superpave mixes with small stones (Hynes, 2004). This resulted in significant costs to change requirements on several in-service contracts, and it was expected to increase bid prices for those mixes corresponding to the higher quality aggregate needed to meet friction requirements.

Other points made by state representatives were related to the bid prices and construction considerations of HMA mixes having different additives (e.g., recycled glass, recycled rubber, slag, fly ash) and aggregates with different polish/wear characteristics.

Concrete Surfacing Techniques and Restoration Treatments

The economic considerations for concrete surfacings and treatments mostly center around the surface texturing (burlap or turf dragging, brooming, tining, exposed aggregate texturing, grooving, grinding, abrading, plastic brushing) or surface dressing (chip sprinkling), but also the properties of the aggregate and cement paste. Again, the economic consequence of using alternative methods/materials requires the acquisition and analysis of up-to-date unit bid prices and pertinent forms of time-series performance data (e.g., distress, ride, friction, noise). Information concerning construction time requirements and other construction-related issues is also important.

As with asphalt surfacing mixes and restoration treatments, the compiled literature contained several documents focusing on the performance characteristics of different concrete texturing techniques and restoration treatments. Only a few of them included specific assessments of costs tied in with friction and friction-related performance. Studies by the Michigan DOT and FHWA (Buch et al., 2000), the Colorado DOT (Ardani and Outcalt, 2000), and the Oregon DOT (Hunt, 1999) looked at the performance and costs of different concrete texturing techniques (in Michigan, exposed aggregate texturing and transverse tining; in Colorado, uniform transverse tining [with and without Astroturf drag] and various longitudinal tining [with Astroturf drag]; in Oregon, millabrading and diamond grinding).

The most pertinent concrete study is an on-going, FHWA-funded study initiated in 1998 and to be completed in 2005. In this study, two different forms of texturing—randomly spaced transverse tining and longitudinal diamond grinding—were implemented on a new PCC pavement on I-190 in Buffalo, New York (Burge, Travis, and Rado, 2001). Results of friction and macro-texture testing and analysis after 2 years, indicated somewhat higher levels of friction for the longitudinally ground surface as compared to the transverse tined surface, but a generally greater loss of macro-texture. In terms of noise, the longitudinally ground surface was shown to be 2 to 5 dBA quieter than the transverse tined surface. Although the construction cost and time associated with diamond grinding was found to be higher than transverse tining, it was expected that these costs would be partly offset by an extended service life.

Interviews with selected state agencies did not reveal any specific studies involving the economic impacts of PCC friction design and management. However, a few of the states were very interested in the latest performance and cost-effectiveness information concerning different tining techniques (transverse or longitudinal, uniformly- or randomly-spaced), as well as other initial texturing options, such as the Astroturf drag used by Minnesota. As a case in point, the Michigan DOT noted of a recent project on I-275 near Detroit where the randomly spaced tines were not completed as required, resulting in a noisy pavement (Hynes, 2004). In response, the Department had the surface diamond ground, only to observe low friction numbers a few years later.

Closing

As discussed previously, several of the documented studies found in the compiled literature involved assessments of friction, texture, and/or noise performance. Although costs were not examined directly in most of these studies, the implications of low friction and inadequate drainage (increased crashes) and of high noise (need for noise mitigation) from which costs can be derived were often discussed. Hence, the value of these documents in further defining the economic impacts of friction and friction-related properties is well recognized.

PAVEMENT–TIRE NOISE

Pavement surface texture is generally accepted as one of the major contributors to pavement–tire noise; however, the exact role of texture is not completely understood. Two types of tire noise measurements have been made to quantify the effects of texture: near-field and far-field measurements. Far-field noise is more relevant than near-field noise because it is a measure of community noise impact. Commonly, efforts are directed toward control of far-field noise through the use of barriers rather than through the mitigation of noise at the source. However, near-field noise is less difficult to measure or predict. Therefore, near-field noise will be a useful measure of tire/pavement noise when correlated to far-field noise. Efforts to achieve this correlation are underway. However, the effects of pavement surface texture on far-field pavement–tire noise are extremely difficult to predict. Actual noise can vary as a result of the reflecting surfaces at the test site, wind velocities, ground absorption, attenuation of the sound by foliage, and thermal gradients.

Primary pavement-tire noise research activities are currently focused in Arizona, California, and Indiana. In April 2003, Arizona DOT received pilot status with FHWA to allow pavement surface type as an accepted noise mitigation strategy (Scofield 2003a). This status permits ADOT to receive a 4 dBA credit in pavement noise design for using asphalt rubber friction course (ARFC) materials. Final allowance will be considered at the conclusion of a 10-year, \$1 million ADOT noise research effort that includes evaluating both AC and PCC pavements. PCC pavement textures being evaluated include standard 1-in (25-mm) transverse tining, random transverse tining, 1-in (25-mm) longitudinal tining, and several diamond grinding methods. AC pavement types include ARFC, permeable European mixture (PEM), stone matrix asphalt (SMA), neat-asphalt friction course, polymer modified friction course, and terminal blend asphalt friction course (Scofield, 2003b).

Several pavement-tire and vehicle noise measurement methods are being used by ADOT. These include using a near-field Close Proximity (CPX) trailer designed by the NCAT and modified to include both sound pressure and noise intensity probes. Measurements have also been collected using a separate vehicle equipped with unshielded noise intensity probes. Far-field Statistical Pass-By noise measurements are also being collected regularly along with significant environmental data. Some Pass-by testing is being conducted on a PCC test site. Vehicle speed and measurement offset are also being evaluated. Most of the evaluations are scheduled to continue for at least 10 years.

Among the objectives of the research include validating the 4dBA reduction allowance for ARFC, quantifying the acoustic properties of ARFC over time, defining a correlation between near field and far field noise measurements, evaluating pavement material properties for acoustical performance, develop test procedures for evaluating the noise potential of AC mixtures, develop procedures for noise construction quality control, and others (Scofield, 2003a).

CALTRANS has also been conducting pavement and vehicle noise research, and working closely with ADOT, has received similar pilot status. They are reportedly analyzing open graded asphalt friction course material as their primary noise reduction surface (APA, 2003). A side finding reported from this research is that pavement-tire noise on PCC pavements can be affected by the joint reservoir width and overfilling the joints with sealant (Roberts, 2004).

The ISQDH at Purdue University has been conducting noise and materials analysis using their drum facility, laboratory, and other sound measuring systems. Their recent research has included analysis of the effect of pavement texture on pavement-tire noise (Bernhard et al., 2003), development of quiet and durable porous PCC materials (Olek et al., 2003), and developing porous AC mixes for noise control application (McDaniel et al., 2003). Reports on development of porous modified asphalt mixes for noise control applications and relating surface texture of rigid pavement with noise and skid resistance are expected to be released in summer 2004. An FHWA quiet pavement European scanning tour is also scheduled for the summer of 2004.

SUGGESTED IMPROVEMENTS TO FRICTION PRACTICES AND DESIRED AREAS OF FRICTION GUIDANCE

Agency personnel face differing challenges in designing and managing their pavements for friction, safety, and noise. Economic and other factors can limit their ability to adequately resolve these challenges. Critical to that process, however, is identifying the weaknesses and problems in a process. When agency personnel were asked about changes they would like to see implemented in their friction design and management programs, their answers were typically related to incorporating friction management into pavement management systems, developing friction specifications for new construction, and defining relationships between aggregate sources, properties, and performance. Among their desired changes were the following (Brady, 2004; Geary, 2004; Hynes, 2004; McGhee, 2004; Pierce, 2004; Rasoulion, 2004; Skerritt, 2004; Stampely, 2004; Vacura, 2004):

- Network testing and collection focused on critical information.
- Evaluate and implement construction quality assurance (QA), if deemed necessary.
- Modify and update the pavement management system database to provide pavement section history, aggregate types, aggregate properties, friction history, and crash history.
- Use wet weather crash data more effectively.
- Incorporate friction data into the DOT pavement management database.
- Break down friction data by construction project and integrate it into the PMS system.
- Make friction testing part of the pavement management system.

- Develop performance-related specifications for SN40R on new construction projects.
- Define the relationship between quarry sources, aggregate properties, as-built SN40R, and long-term SN40R.
- Develop and implement method of testing for qualifying aggregate according to polishing resistance.
- Incorporate texture (and IFI) into friction management/design/etc.
- Develop standards for classifying aggregate based on performance and the need for dedicated funding for safety improvements.
- Develop of texture-based measurement.
- Identify aggregate sources that work (matching aggregate with performance).
- Identify particular designs (AC mixes, PCC textures) that work.

Based on these and other perceived needs, interviewed agency personnel also provided listings of what specific guidance they would like to see in the new Guide for Pavement Friction. Their responses indicated a particular desire for the Guide to include background information and assistance managing, designing, and constructing highway pavements with good long-term frictional properties. Specific items requested included the following:

- Provide background information on friction management, design, construction, legal, and economic issues.
- Provide performance information on aggregate types.
- Provide information about methods for designing pavement to ensure friction.
- Provide information about management methods and alternative frameworks, advantages and disadvantages.
- Provide specific guidance on the viability and design limits (related to friction) of such additives as recycled glass, recycled rubber, slag, and fly ash.
- Include specific guidance on aggregate analysis (including petrographic examination) and a better understanding of aggregate properties and methods for analyzing these properties.
- Provide more information on the effect of asphalt modifiers on friction.
- Document what other states are doing to address pavement frictional needs (i.e., how they select mix designs, crash location correction, etc.).
- Provide guidance in liability issues.
- Provide an understanding of texture (micro and macro), and its effect on friction, noise, and other factors.
- Clarify the effect of anti-lock brake systems on friction measurement and design.
- Provide good information about seasonal friction variability, long-term friction trends of different aggregates, temperature variation effects, and speed variation effects.
- Provide guidance on how the impending peak friction number can be used.
- Provide a concise pavement friction handbook that clearly describes related issues for engineers and aggregate producers. People need a big-picture understanding of what's happening in aggregate wear, data collection, and testing. It should be written to include word pictures to allow the readers to visualize the concepts (e.g., the energy expended in hundreds of thousands of cars braking on a pavement surface).
- Provide methods for surgically remediating critical sections with fast, high-quality fixes that will last 8 to 15 years (e.g., microsurfacing with expanded clays or other materials).

- Provide methods for defining the worst frictional demand conditions not particularly based on volume (e.g., energy input).
- Provide detailed guidance or a case studies synthesis (what's been done, what worked) on matching aggregates with frictional performance, matching AC mixes and PCC textures with frictional performance, and resolving PCC noise and skid problems.
- Provide assistance with how to design mixes with sensitivity to friction, noise, splash and spray.
- Provide tort liability protection methods.
- Quantifying the benefits of friction management and design.
- Provide guidance in how to transition from ribbed to the smooth tire as well as the IFI (micro-texture and macro-texture). The Guide should provide some flexibility, not hard-and-fast numbers. On the other hand, the Guide should not be so flexible as to allow every individual practice, as is currently the case with the AASHTO Guide on pavement smoothness testing.

REFERENCES

Ardani, A. and W. Outcalt. 2000. *PCCP Texturing Methods, Final Report*, Report No. CDOT-DTD-R-00-1, Colorado Department of Transportation Research Branch, Denver, Colorado.

Asphalt Pavement Alliance (APA). 2003. "Big Noise over Noise Reduction," Alliance in Action newsletter, March 10, 2003, website: <http://www.asphaltalliance.com/upload/e-Alliance%20in%20Action%20March%202003.pdf>, Lexington, Kentucky.

Beck, W and F. Holt. 2004. Notes from Feb 17, 2004 teleconference with Bill Beck and Frank Holt of Dynatest Consulting, Inc.

Bernard, R.J., W.D. Thorton, and J Bauman. 2003. "The Effects of Varying the Tire Cap Ply, Sidewall Filler Height, and Pavement Surface Texture on Tire/Pavement Noise Generation," Final Report, SQDH 2003-1, HL 2003-1, The Institute for Safe, Quiet and Durable Highways (ISQDH), Purdue University, West Lafayette, Indiana.

Brady, P. 2004. Notes from February 19, 2004 teleconference with Mr. Patrick Brady, Florida Department Transportation State Traffic Safety Engineer.

Brakey, B.A. 1973. "Design, Construction, and Performance of Plant Mix Seals." FHWA Notice, Washington, D.C.

Buch, N., R. Lyles, and L. Becker. 2000. "Cost Effectiveness of European Demonstration Project: I-75 Detroit," Report No. RC-1381, Michigan Department of Transportation, Lansing, Michigan.

Burge, P.L., K. Travis, and Z. Rado. 2001. "A Comparison of Transverse Tined and Longitudinally Diamond Ground Pavement Texturing for Newly Constructed Concrete

Pavement,” Paper prepared for the 2002 Annual Meeting of the Transportation Research Board, Washington, D.C.

Buys, R. 2004. Notes from March 11, 2004 teleconference with Romain Buys, General Manager with N.V. Robuco, Ltd in Buggenhout, Belgium.

Chelliah, T.C., P. Stephanos, M.G. Shah, and T. Smith. 2003. “Developing a Design Policy to Improve Pavement Surface Characteristics,” Paper presented at 2003 Annual Meeting of the Transportation Research Board, Washington, D.C.

Choubane, B., G.A. Sholar, J.A. Musselman, and G.C. Page. 1999. “A Ten-Year Performance Evaluation of Asphalt Rubber Surface Mixes,” Paper presented at the 78th Annual Meeting of the Transportation Research Board, Washington, D.C.

Cram, I.A. 1975. “Asphalt Surface Treatments,” Highway and Road Construction, Vol. 43 No. 1782/3, pp. 18-20.

Federal Highway Administration (FHWA). 1973. “Open Graded Plant Mix Seals” FHWA Pavement Design Branch, FHWA Notice, Washington, D.C.

Galloway, B.M. et al. 1975. “Tentative Pavement and Geometric Design Criteria for Minimizing Hydroplaning,” Final Report, FHWA, Report No. FHWA-RD-75-11, Texas Transportation Institute, College Station, Texas.

Geary, G. 2004. Notes from February 17, 2004 teleconference with Ms. Georgene Geary, State Materials and Research Engineer, Georgia Department of Transportation.

Gomaco. 2004. “The World's Quietest Paver Slipforms A Quiet New Roadway,” Gomaco World 32.1, February 2004, Website: http://www.gomaco.com/Resources/worldstories/world32_1/betonac.html, Ida Grove, Iowa.

Hunt, E.A. 1999. “Millabrading Test Evaluation,” Report No. FHWA-OR-RD-00-02, Oregon Department of Transportation, Salem, Oregon.

Hunt, E.A. 2002. “Crumb Rubber Modified Asphalt Concrete in Oregon,” Report No. FHWA-OR-RD-02-13, Oregon Department of Transportation, Salem, Oregon.

Hynes, T. 2004. Notes from February 19, 2004 teleconference with Mr. Tom Hynes, Pavement Evaluation Engineer with Michigan Department of Transportation.

International Symposium on Porous Asphalt (ISPA). 1977. Proceedings. SCW Record 2. Study for Road Construction, Amsterdam.

Lyon, B. 2004. Notes from Feb 16, 2004 teleconference with Bill Lyon of the Transportation Research Center.

McDaniel, R.S. and B.J. Coree. 2004. “Identification of Laboratory Techniques to Optimize Superpave HMA Surface Friction Characteristics,” Phase I, Final Report, SQDH 2003-6,

HL 2003-19, Institute for Safe, Quiet, and Durable Highways (ISQDH), Purdue University, West Lafayette, Indiana.

McGhee, K. 2004. Notes from February 18, 2004 teleconference with Mr. Kevin McGhee of the Virginia Transportation Research Council.

Metcalf, S. 2004. Notes from February 16, 2004 teleconference with Scott Metcalf, technical marketing engineer with Koch Pavement Solutions in Fontana, California.

National Cooperative Highway Research Program (NCHRP). 1974. "Wear-Resistance and Skid Resistant Highway Pavement Surfaces." *NCHRP Research Results Digest 61*. Highway Research Board, Washington, D.C.

National Cooperative Highway Research Program (NCHRP). 1978. "Open-Graded Friction Courses for Highways." *NCHRP Synthesis of Highway Practice 49*, Transportation Research Board, Washington, D.C.

Nippo Sangyo. 2003. Nippo Sangyo Ltd. website, <http://www.nippou.com/product3e.html>, Tokyo, Japan.

Olek, J, W.J. Weiss, and R. Garcia-Villarreal. 2004. "Relating Surface Texture of Rigid Pavement with Noise and Skid Resistance," Final Report, SQDH 2004-1, HL 2004-1, The Institute for Safe, Quiet and Durable Highways (ISQDH), Purdue University, West Lafayette, Indiana.

Olinoski, R and B. Olinoski. 2004. Notes from Feb 18, 2004 teleconference with Rob and Bob Olinoski of International Cybernetics Corporation.

Pierce, L. 2004. Notes from February 18, 2004 teleconference with Ms. Linda Pierce, Pavement Design Engineer with Washington Department of Transportation.

Pilkington, G.B. 1982. "Reduction of Truck-Induced Splash and Spay." *Public Roads*, Volume 46, pp. 6-12, Washington, D.C.

Public Roads. 2003. "Alternative Pavement Surfaces May Reduce Roadway Noise," *Public Roads*, May/June, Federal Highway Administration, Washington, D.C.

Rasoulia, M. 2004. Notes from February 19, 2004 teleconference with Mr. Masood Rasoulia, Louisiana Transportation Research Center.

Ritter, T.E. 1974. "The Development of Techniques to Measure Vehicle Spray on Wet Roads," SAE Transactions, Vol. 83, Paper No. 74026, Washington, D.C.

Rowdan, L. 2004. Notes from February 19, 2004 teleconference with Ms. LaDonna Rowdan, Illinois Department of Transportation.

Roberts, J. 2004. Notes from March 1, 2004 teleconference with John Roberts, Executive Vice President of the International Grooving and Grinding Association in New York.

- Sabey, B.E. 1973. "Accidents: Their Cost and Relation to Surface Characteristics." Symposium on Safety and the Concrete Road Surface-Design, Specification and Construction, Cement and Concrete Association, Birmingham, United Kingdom.
- Scofield, L. and P.R. Donavan. 2003. "Development of Arizona's Quiet Pavement Research Program," Arizona Department of Transportation, Phoenix, Arizona.
- Scofield, L. 2003. "SR202 PCCP Whisper Grinding Test Sections – Construction Report," Arizona Department of Transportation, Phoenix, Arizona.
- Skerritt, W.H. 2004. Notes from February 19, 2004 teleconference with Mr. Bill Skerritt of the New York Department of Transportation, Engineering Geology section of the Materials Bureau.
- Sorensen, K. and B. Nielsen. 1974. "Road Surfaces in Traffic Lighting." Danish Illuminating and Engineering Laboratory, Ministry of Public Works, Lyugby, Denmark.
- Stampley, B. 2004. Notes from February 13, 2004 teleconference with Mr. Bryan Stampley, Pavement Management Engineer with Texas Department of Transportation.
- Texas Department of Transportation (TXDOT). 2004. Concrete Rated Source Quality Catalog and Bituminous Rated Source Quality Catalog, Material Producer List, Texas DOT, <http://www.dot.state.tx.us/business/materialproducerlist.htm>, Austin, Texas.
- United States Department of Transportation. 1980. Skid Accident Reduction Program, *Technical Advisory T 5040.17*, Federal Highway Administration, Washington, D.C.
- Vacura, P. 2004. Notes from February 19, 2004 teleconference with Mr. Peter Vacura, California Department of Transportation.
- Western Highways Institute (WHI). 1973. "Splash and Spray Characteristics of Trucks and Truck Combinations," Research Committee Report No. 5.
- Wambold, J.C., Henry, J.J., and R.R. Blackburn. 1984. "Pavement Surface Texture: Significance and Measurement." FHWA contract DOT-FH-11-9091, PTI Report PTI 8312, College Station, Pennsylvania.
- Yeakel, S. 2004. Email correspondence on March 1, 2004 from Skip Yeakel, Principal Engineer at Volvo Trucks.
- Zimmer, D. 2004. Notes from Feb 17, 2004 teleconference with Dick Zimmer of the Texas Transportation Institute.

APPENDIX E
PRIMER ON FRICTION

INTRODUCTION

This primer is based in part on a 1999 report written for the Joint Winter Runway Friction Measurement Program and the American Society for Testing and Materials (ASTM) (Andresen and Wambold). It is intended to provide background material for users of braking slip measurement devices, with emphasis on topics related to comparison and harmonization of friction measurement devices. It describes different aspects of measuring braking slip friction on traveled surfaces. In practice, all types of surfaces and conditions are encompassed, ranging from bare and dry to pavements covered with precipitation deposits, and thus a year-round context is provided.

The mechanics of various combinations of tire–surface interaction mechanisms are discussed. A step-by-step, parallel case presentation of a force-measuring friction device and a torque-measuring friction device highlights the difficulties of obtaining mechanical error-free measurements of braking slip friction. Models for the interaction between a braked tire and a surface are presented and discussed, as are several approaches to harmonization of friction measuring devices. The International Friction Index (IFI), as proposed by the World Road Association (PIARC), is presented and discussed.

Who is This Primer For?

Although the generated friction phenomenon between a braked wheel and a traveled surface may be covered in many different textbooks of science and engineering, no single source has been found that is dedicated to the measurement of braking slip friction. There are hundreds of research papers that report on various aspects of braking slip friction. This primer does not purport to reflect an overview or summary of findings from a literature study. Rather, it is a collection of topics that were visited by the authors during planning of field tests, analysis of collected data and design work for a harmonized unit of friction measure and the standards development process within ASTM Committee E17 on Vehicle-Pavement Systems.

The primer covers elementary mechanics, dynamic influences on friction by winter contaminants, physical modeling of friction, elements of applied statistics, variability of friction measures and standard friction measures. Since the treatment of these topics seeks to establish sound ways of comparing and harmonizing friction measurements, some aspects may require further investigation or careful evaluation before they are fully accepted in the field of tire–surface friction measurement.

This primer is intended to serve as a guide or discussion text for researchers, tire–surface measurement method designers, equipment manufacturers, and operators in the field of measuring braking friction by public service regulators, highway engineers, maintenance personnel, and other users of road and highway friction information.

Andresen, A. and J.C. Wambold. 1999. “Friction Fundamentals, Concepts, and Methodology,” Report TP 13837E, Transportation Development Centre, Transport Canada, Ottawa, Ontario, Canada.

The Friction Measurement Devices

A number of different types of devices have been invented and deployed at different highway agencies to provide information about the road surface frictional characteristics. Few devices have been designed specifically for predicting ground vehicle braking performance. These devices have to meet demands for ease of use, low cost of purchase and maintenance, consistency of measured results, and reliability of operation. Devices that measure acceleration during a change of velocity or that measure force for a continuous braked wheel have become very popular.

In this primer, the focus is on the common characteristics of devices rather than on the individual device types used for friction measurement. The goal is to establish a basis for harmonization of their outputs.

The friction measurement devices used in road and highway friction measurements can be grouped into five families:

- Locked-wheel testers that have a fully braked wheel measuring short segments of the road periodically.
- Side-force friction measurement devices that have a test wheel, mounted in line with the wheel track and angled to the direction of travel, under a known load. These devices can be related theoretically to the fixed-slip measurement devices.
- Fixed-slip testers that have a fixed and continuous level of applied braking on the measuring wheel.
- Variable-slip testers that have a variable controlled level of braking, usually with a governing time function that is repeated in continuous cycles.
- Decelerometer testers, where the brakes of the host vehicle are applied sufficiently hard to lock the wheels and retard the vehicle for a short distance and time. The vehicle is accelerated to the same initial speed before another deceleration is initiated.

The braking slip testers (both fixed and variable) are typically outfitted with strain gauges to measure the following:

- One force parallel with the surface, using the static weight as the normal load;
- Two forces, one parallel with the surface and one normal to the surface;
- One torque measurement of the wheel braking moment using the static weight as the normal load; or
- Combination of force and torque measurements.

Focus on Braking Slip Friction

Measurements of friction, as reported by friction testers, are really aggregated measurements of different forces induced by motion that are present in variable quantities for different pairs of braked wheels and surfaces. The purpose of braking a wheel is to make controlled use of what may be called the braking slip friction. Other forces induced by the motion are not controllable and constitute unwanted influences on the braking slip friction. The rolling resistance stems from the mechanics of the rolling tire.

Several other resistive forces can be important to the stopping of a vehicle. Aerodynamic drag and impingement drag are examples of non-frictional stopping forces. Discussion regarding the stopping of a vehicle is outside the scope of this primer; the reader is referred to textbooks on vehicle dynamics that cover stopping a vehicle.

THE NATURE OF BRAKING SLIP FORCES

Main Mechanisms of Braking Slip Friction

Although the mechanisms of braking slip friction is not fully understood, the process is regarded by many experts as a composition of three main elements:

- Adhesion.
- Hysteresis.
- Shear (wear, tear).

Figure E-1 depicts these mechanisms in the tire–surface interface. The shear is indicated for a non-rigid surface material only.

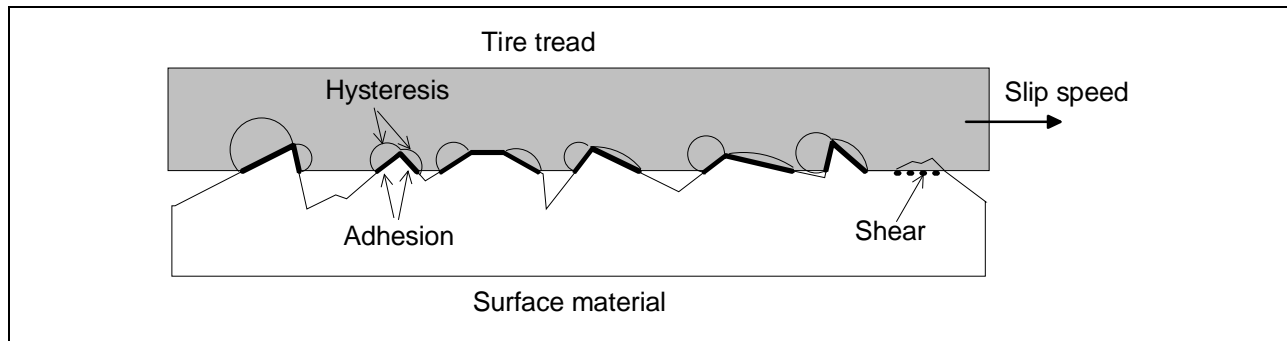

Figure E-1. An exploded view of a tire–surface interface.

The braking slip force, F_B , can be viewed as a sum of three terms:

$$F_B = F_{adhesion} + F_{hysteresis} + F_{shear} \quad \text{Eq. E-1}$$

Surface texture influences all three mechanisms. The adhesion force is proportional to the real area of adhesion between tire and surface asperities. The hysteresis force is generated within the deflecting and visco-elastic tire tread material and is a function of speed. The shear force is proportional to the area of shear developed. Generally, adhesion is related to micro-texture whereas hysteresis is mainly related to macro-texture. For wet pavements, adhesion drops off with increased speed while hysteresis increases with speed, so that above 56 mi/hr (90 km/hr), the macro-texture has been found to account for over 90 percent of the friction. In the case of winter friction on snow and ice, the shear strength of the contaminant is the limiting factor.

Figure E-2 depicts typical compositions of the braking slip friction mechanisms for two different surfaces interacting with the same tire. The pie chart on the left depicts a rigid surface, such as a dry, bare pavement. The pie chart in the middle depicts a wet pavement. The pie chart on the right depicts a non-rigid surface material.

For a tire tread in contact with a rigid surface, the shear force is usually regarded as small. Adhesion and hysteresis make up 80 to 90 percent of the braking slip force. Pieces of tire tread are torn off when interfacing with a rigid surface. The tire is therefore called the sacrificial part of the braking slip friction process.

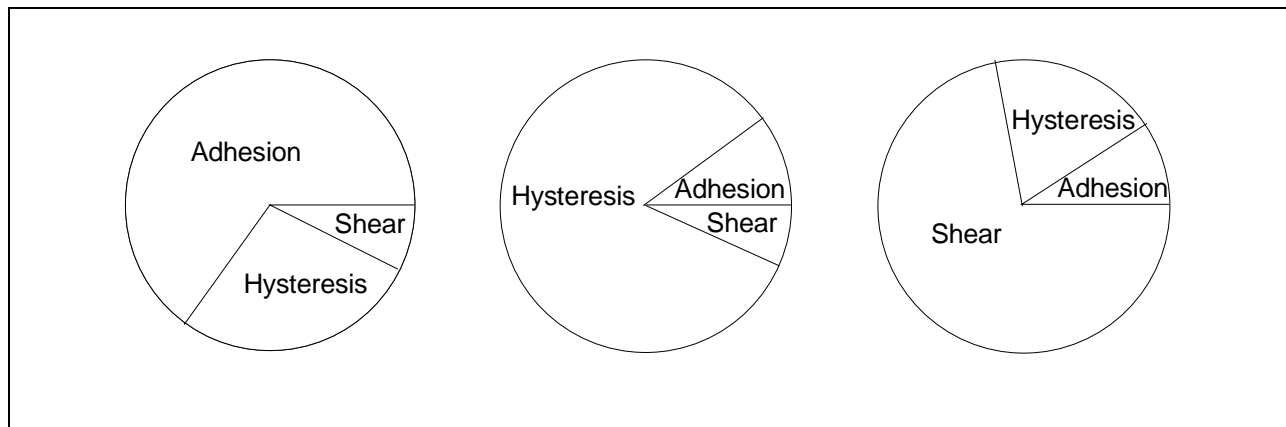

Figure E-2. Three theoretical sample compositions of major influences on braking slip.

A significant shear force contribution implies that the sacrificial component is being sheared. In other words, the shear force is proportional to the product of the ultimate shear stress of the surface material and the real area of shearing contact.

Because of the markedly different compositions of braking slip mechanisms for rigid versus non-rigid surfaces, a question is raised whether the braking slip process can be considered sufficiently uniform for different compositions to be included in the same comparison of friction testers. Intuitively, the nearly same compositions of braking slip mechanisms would produce the best correlations. Thus, comparison of devices on compacted or rolled snow would differ from comparisons on pavement.

Simple Friction Models

Amontons Friction Model

The simplest friction model for two objects in contact and undergoing opposing movement is the familiar Amontons¹ friction model. It states that the pulling force required to sustain an opposing motion of a pair of interfacing objects is directly proportional to the perpendicular contact force. This pulling force is called the friction force and is independent of the apparent contact area. The factor of proportion has been named the

¹ Guillaume Amontons, French physicist, 1699.

coefficient of friction, μ . In figure E-3, the perpendicular contact force is the weight of the block, F_w . The Amontons equation is as follows:

$$F = \mu \cdot F_w \quad \text{Eq. E-2}$$

The friction is a measure of the resistive interaction of the interfacing objects. The friction is a characteristic of the two objects. The Amontons equation works best for solid objects.

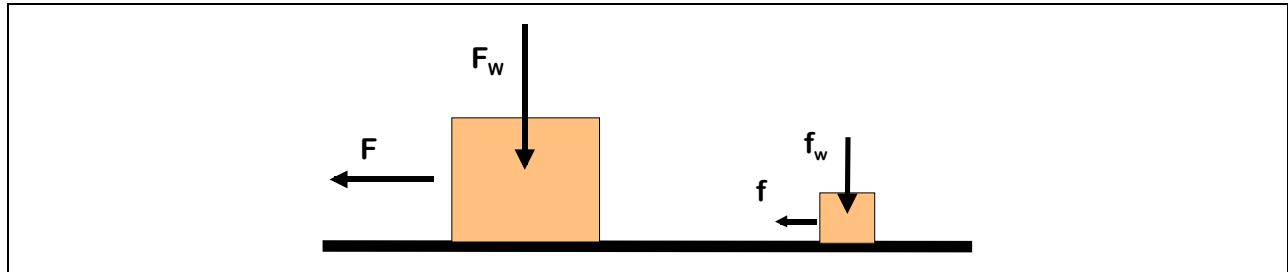

Figure E-3. Pairs of objects of same material of different size and weight having the same and constant coefficient of friction.

This friction model is commonly used to estimate the force required to sustain the opposing motion when the perpendicular contact force and the friction coefficient for the interfacing materials are known.

If the Amontons model holds true equally well both for the friction measurement device and the vehicle–tire interaction with the road surface, a friction coefficient acquired with the ground friction measurement device could be applied to a vehicle tire and suspension (see figure E-4).

In the interaction between a pneumatic tire and a surface, dependencies on many parameters are encountered for the friction coefficient. This makes the Amontons friction model invalid for application with pneumatic tires. It is evidenced by the fact that different types of friction measurement devices report different values of the friction coefficient when measuring the same surface. In essence, this is the reason why it is necessary to transform friction values to a common unit of measure. It must be acknowledged that each type of device equipped with a tire has its own proprietary set of reported numbers expressing friction.

There are several reasons for this diversity. The flexible tire object manufactured from visco-elastic materials is a cause of non-linearity. The irregularity of the surface, called texture, is another major factor. Different tire–surface pairs exhibit different non-linearity characteristics of friction. Wet pavement with low texture content against a bald tire tread, for example, will have a pronounced reduction in the coefficient of friction as travel speed increases.

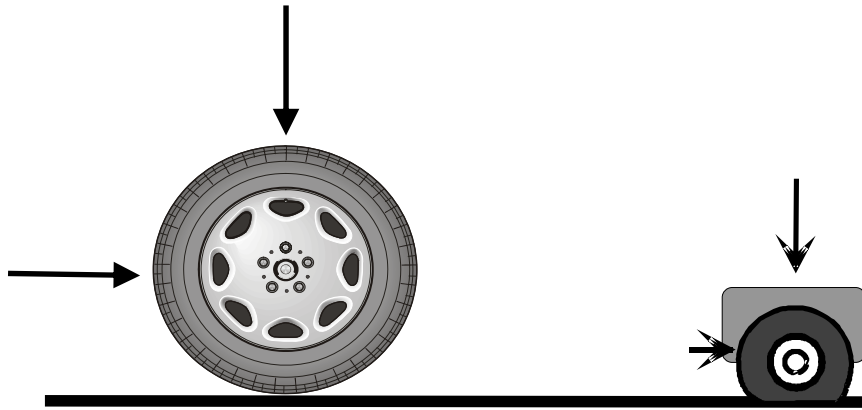

Figure E-4. Two wheels of different size and type on the same surface.

Friction is a phenomenon of surfaces in contact under opposing motion. The relative motion is called slip speed.

Slip Speed and Slip Ratio

The difference in tangential speed for a point on the tire circumference in the contact area when it is free-rolling versus braked at a constant travel speed of the wheel axis is called slip speed. The tangential speed for a free-rolling tire is equal to the travel speed. When the tire is braked, its tangential speed is less than the travel speed, as the travel speed is kept constant.

When V is the travel speed and V_B is the tangential speed of the tire when braked, the slip speed, S , is $V - V_B$. The tangential speed is the rotational speed, ω , multiplied by the deflected tire radius, r .

$$S = V - V_B = \omega \cdot r - \omega_B \cdot r = r \left(\omega - \omega_B \right) \quad \text{Eq. E-3}$$

By measuring the rotational speeds of the tire in free-rolling mode, ω , and braked mode, ω_B , the slip speed can be calculated with the above equation.

The ratio of the slip speed to the travel speed is called a slip ratio, λ . It can be expressed as follows:

$$\lambda = \frac{S}{V} = \frac{V - V_B}{V} = 1 - \frac{V_B}{V} \quad \text{Eq. E-4}$$

Friction as Function of Travel Speed and Slip Speed

Figure E-5 illustrates how braking slip friction can vary with travel speed and degree of braking, in terms of slip ratio. This figure suggests that a simplified, universal friction model for tire–surface object pairs can be expressed with a speed variable and a degree of braking called slip speed. With reference to figure E-4, where F_W and f_w are the weights of the vehicles on the wheels, the resistive forces for each tire-device configuration are

$$F(S,V) \approx \mu_L(S,V) \cdot F_W \quad \text{Eq. E-5}$$

and

$$f(S,V) \approx \mu_S(S,V) \cdot f_w \quad \text{Eq. E-6}$$

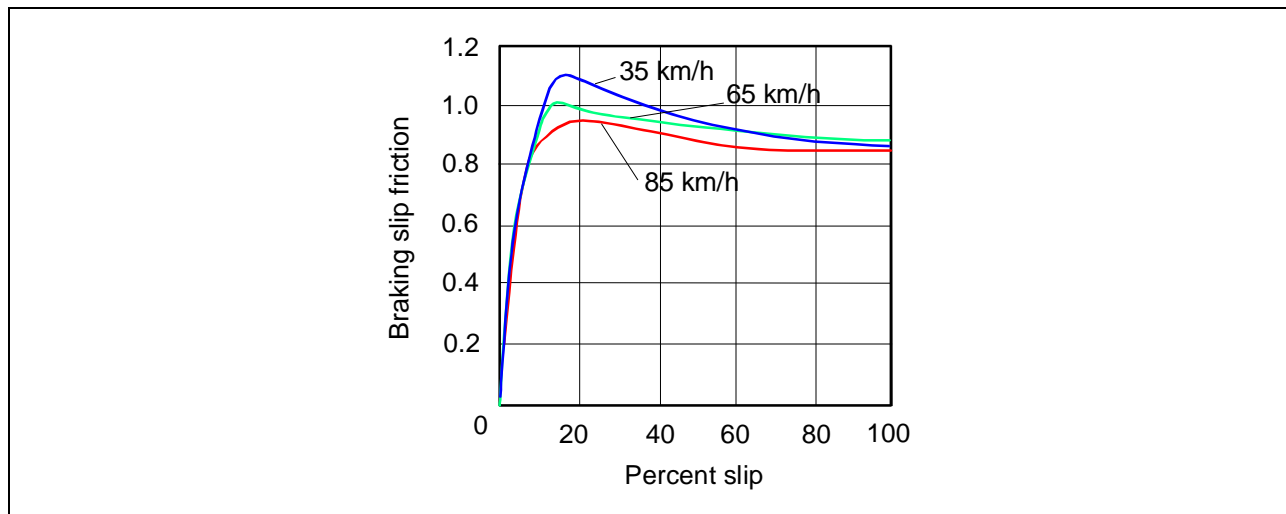

Figure E-5. A case of braking slip friction with automotive tires on a dry surface (Clark, 1981).

Since different friction measuring tires measure different friction values because of differences in contact area, rubber compound, and other parameters, then

$$\mu_L(S,V) \neq \mu_S(S,V) \quad \text{Eq. E-7}$$

Therefore,

$$F(S,V) \neq \mu_S(S,V) \cdot F_W \quad \text{Eq. E-8}$$

Clark, S.K. 1981. "Mechanics of Pneumatic Tires," U.S. Department of Transportation, National Highway Traffic Safety Administration, Washington, D.C.

There are circumstances in which the friction has negligible influences of traveling speed and degree of braking, but for a universal friction model those circumstances are special cases. To circumvent this, a frequent tactic is to fix the measuring speed and slip speed and compare the device-tire configurations at those speeds.

Vehicle Braking Friction

When braking a vehicle to stop from low speeds on a level surface, the braking slip friction force generated in the tire–surface interaction equals a decelerating force acting on the vehicle mass:

$$F_{braking} = F_{deceleration} \quad \text{Eq. E-9}$$

The applied braking force is equal to the deceleration force of the vehicle body mass according to Newton’s law:

$$\mu \cdot F_W = \frac{F_W}{g} \cdot a \quad \text{Eq. E-10}$$

where g is the gravitational constant and a is the deceleration. Simplifying the expression, the friction coefficient is as follows:

$$\mu = \frac{a}{g} \quad \text{Eq. E-11}$$

This is a popular relationship used in determining the average friction coefficient (over the speed range) by measuring the deceleration of the vehicle. It is also frequently used in rough estimates of the average braking performance of vehicles in terms of deceleration on a surface, assuming the friction coefficient is valid for the vehicle-surface pair.

At higher speeds, or when better accuracy is required, the braking equation can include other resistive terms such as aerodynamic resistance, longitudinal slope of the surface, displacement drag from liquid, fluid or plastic materials, impingement drag on the vehicle body from loose surface material, hydroplaning effects, brake efficiencies, weigh-in-motion and other parameters. Since these effects are not braking slip friction by nature, they must be assessed and used to correct a measured deceleration value to determine a braking slip friction coefficient. Or, when modeling the stopping of a vehicle, the effects of non-friction influences must be properly included.

MECHANICS OF TIRE–SURFACE INTERACTIONS

To understand the braking slip friction processes on a macro-scale, it is helpful to look at the mechanics of the interaction between a braked wheel with a pneumatic tire and different surface types and conditions. The material covered here is general. An actual friction measuring device design will have a unique geometry and a unique suspension that will require its own unique elaboration of mechanics. A distinction is made between force-measuring devices and torque-measuring devices. The different features of these two

groups of devices are highlighted. Intermittent or spot friction measuring devices are not fully addressed in this primer.

In this primer, torque refers to measured moments transmitted by an axle. Applied torque on an axle to produce braking is referred to as an applied moment.

Mechanics of a Wheel in a Constant and Continuous Measuring Mode

Continuously measuring friction measurement devices operate at a constant travel speed. Furthermore, fixed-slip devices have no angular acceleration of the measuring wheel. Therefore, fixed-slip continuous friction measurement devices may be studied in steady-state equilibrium.

The next few sections treat individual aspects in a cumulative manner, starting with a free-rolling tire, then adding drag, planing from a fluid contaminant and, finally, brake actuation.

Rolling Resistance

Even when free-rolling on a hard, non-contaminated surface, there is a resistive force to the tire movement. This is due to the natural and characteristic deflection of a pneumatic tire when rolling. Figure E-6 shows the forces acting on a wheel and tire. The host vehicle pulls the tribometer at a constant speed with force F_x . The normal load on the measuring wheel is F_w .

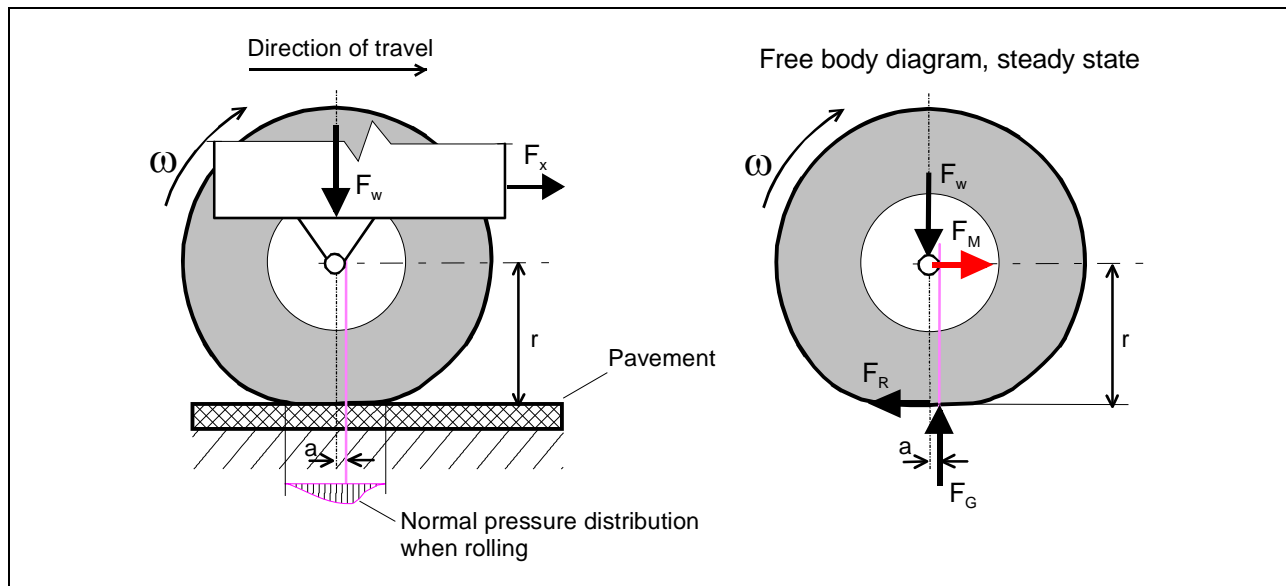

Figure E-6. Rolling resistance force with a free-rolling tire at constant speed.

A small longitudinal tire slip force in the footprint supports the deflection work. As a result, the normal pressure distribution becomes uneven, such that the resultant normal force (center of pressure) from the ground, F_G , is leading the vertical through the wheel center, and thereby creates a balancing resistive moment. The distance a by which the resultant force is leading the wheel axle is increasing with accelerating travel speed.

The rolling resistance moment, $F_G a$, must be opposed with a moment, $F_R r$, applied about the wheel axis, if the wheel is to maintain a constant rotation and travel speed typical of continuous friction measurement devices. The wheel in figure E-6 can only produce this opposing moment by tire slip in the contact area when wheel-bearing resistance is disregarded. The surface is reacting to the slip with the force F_R . If the surface is incapable of sustaining this slip, the wheel will not rotate. It will instead slide in its load-deflated state. This rarely happens, since the attainable friction force in all practical cases is greater than F_R .

Summation of the moments about the wheel axis yields

$$F_G \cdot a - F_R \cdot r = 0 \quad \text{Eq. E-12}$$

There is no torque transmitted over the wheel axle to other shafts or axles. A torque-measuring friction device is designed to measure the axle torque and therefore would measure zero.

Solving for F_R ,

$$F_R = \frac{a}{r} \cdot F_G \quad \text{Eq. E-13}$$

This equation is a definition of tire rolling resistance. The resistive slip force, F_R , is equal to the ground reaction force, F_G , multiplied by a ratio of geometric parameters, a/r .

In this scenario $F_G = F_W$, and therefore by substitution into equation E-13, the tire rolling resistance for a free-rolling case can be written as:

$$F_R = \frac{a}{r} \cdot F_W \quad \text{Eq. E-14}$$

From summation of horizontal forces in a steady-state equilibrium,

$$F_R - F_M = 0 \quad \text{Eq. E-15}$$

Or rewritten,

$$F_M = F_R \quad \text{Eq. E-16}$$

A force-friction measuring device can measure the rolling resistance force if the design allows the applied brake moment to be uncoupled.

Since the nature of the tire rolling resistance involves slip in the tire–surface contact area, a friction coefficient can be defined as follows:

$$\mu_R = \frac{F_R}{F_W} = \frac{\frac{a}{r} \cdot F_W}{F_W} = \frac{a}{r} \quad \text{Eq. E-17}$$

The tire rolling resistance is geometrically defined. Both a and r may vary with tire design, tire load, speed, degree of braking, influence of contamination, etc.

For dry, rigid horizontal surfaces, the rolling resistance is typically observed to be in the range of 0.5 to 3 percent of the carried weight.

The tire rolling resistance is a tire property and is called tire rolling resistance for clarity to differentiate it from other forms of resistance to rolling, stemming from influences of contaminants as described in later sections. The tire rolling resistance is associated with the presence and location of the ground reaction force, F_G , in the rigid surface contact region with a tire.

Applied Braking Force

To measure braking slip friction, a friction measuring device must apply a braking moment. A scenario with braking is depicted in figure E-7. A constant applied braking slip force, F_B , works opposite to the rotation of the wheel. The applied brake moment, M_B , is the product of the applied force and the radius of the sprocket wheel. The tire rolling resistance force couple (F_R and F_M) is always present when the wheel is rotating.

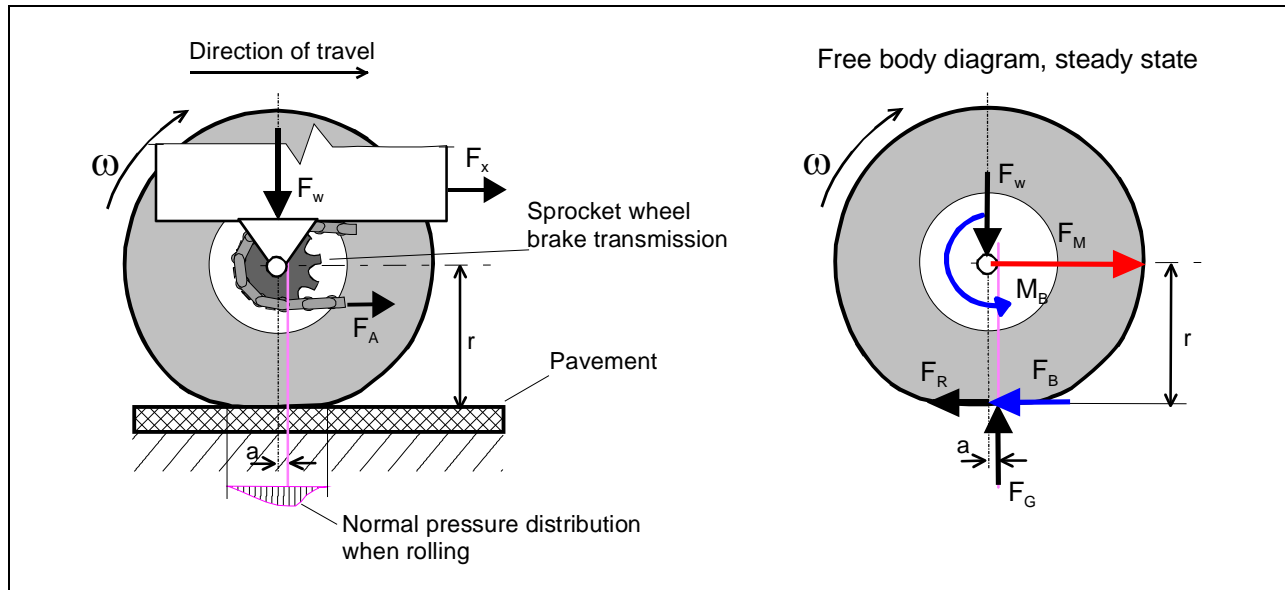

Figure E-7. Forces and moments of a constant braked wheel on a clean and dry rigid surface.

A brake moment causes the wheel rotation to slow down and creates a slip resistive force, F_B , in the tire–surface contact area. An increased pulling force, F_X , is required to uphold the tribometer at a constant speed of travel.

Summing the moments about the wheel axis in equilibrium at steady state,

$$M_B - F_B \cdot r - F_R \cdot r + F_G \cdot a = 0 \quad \text{Eq. E-18}$$

A torque-measuring friction device will, by design, measure the reaction of the applied brake moment, called the measured torque, T_M , that is equal to the applied brake moment, M_B . Solving the above equation for M_B or T_M ,

$$T_M = M_B = F_B \cdot r + F_R \cdot r - F_G \cdot a \quad \text{Eq. E-19}$$

If it can be assumed that the tire deformation during braking has the same basic relationship for tire rolling resistance as for the free-rolling case, and F_G acts in the vertical plane only, then $F_R \cdot r$ equals $F_G \cdot a$ and the measured torque is as follows:

$$T_M = F_B \cdot r \quad \text{Eq. E-20}$$

A torque-measuring friction device does not measure tire-rolling resistance. The braking slip force is equal to the measured torque divided by the deflected radius.

By summation of horizontal forces at steady state

$$F_M - F_B - F_R = 0 \quad \text{Eq. E-21}$$

Solving for F_M ,

$$F_M = F_R + F_B \quad \text{Eq. E-22}$$

A force-friction measuring device measures braking slip and tire-rolling resistance. When the objective is to measure braking slip, the tire-rolling resistance is an error term.

At this point it is instructive to note a simple way to determine tire-rolling resistance by designing and building a friction tester to measure both torque and horizontal force. Solving for F_R in the above equation and substituting for F_B using equation E-20,

$$F_R = F_M - \frac{T_M}{r} \quad \text{Eq. E-23}$$

So far, the forces and moments due to the rolling resistance force and applied braking moment have been discussed. This scenario is valid for friction measurements of clean, dry and rigid surfaces.

Next, drag forces due to fluid contaminant displacement will be studied when a measuring wheel is kept free rolling at a constant speed. This is useful for investigations of displacement drag parameters.

Friction Forces from Contaminant Dynamic Planing²

Planing occurs when the fluid³ contaminant material is trapped under the rolling tire in sufficient quantities at a high enough traveling speed to detach some or the entire tire tread from the base surface. Some, or all, of the tire rides on the trapped fluid contaminant, which acts like a lubricant.

The fluid contaminant gets trapped because there is insufficient time for the fluid to flow out of the footprint area. Also, the surface and tire tread may not have sufficient grooves or voids to allow the fluid to fill into these spaces, and thus escape readily from the tire footprint area.

As the trapped fluid enters the leading edge of the contact area between tire and surface, it gives rise to a fluid lift force acting to separate the tire from the base surface. When the fluid penetration covers all of the contact area with the ground, the tire–surface friction becomes approximately zero. The travel speed in this instance is called the critical hydroplaning speed when the fluid is water.

A scenario dealing with the mechanics of friction tester tires with fluid planing is depicted in figure E-8. This is a free-rolling tire with no brake applied. A major difference from earlier scenarios is the divided reaction force from the ground. There are two forces, F_G and F_L , that carry the normal load, F_W . F_G is the ground reaction force from the base surface still in contact with the tire. F_L is a resultant dynamic fluid lift force from the area of interspersed fluid.

The line of attack for the ground reaction force, F_G , is shifted back in the contact length, distance a from the vertical line through the wheel axis. As a result of this shift in location of F_G , the tire rolling resistance force, F_R , acts counterclockwise in figure E-8. The fluid lift force has a line of attack that is a distance, b , from the vertical line through the wheel axis. The fluid lift force has horizontal ground reaction force, F_{LG} , acting in the tire–surface contact area. The sum of F_R and F_{LG} constitutes a resultant rolling resistance force. The fluid lift force, F_L , sustains no shear forces in its contact area with the tire and, therefore, no slip to support tire-rolling resistance in this area.

Assuming that it acts in the center of the interspersed fluid contact area, F_L always acts ahead of the vertical through the wheel axis until full planing has occurred. At full planing, it acts vertically through the wheel axis.

As the planing progresses, F_G reduces to zero at full planing. The line of attack for the resultant normal reaction force is therefore always ahead of the wheel axis position. In that position, it resists the rotation of the wheel in the same manner as tire-rolling resistance when there is no fluid present.

² Called hydroplaning when the fluid is water.

³ It is debatable whether to consider and call the different loose winter contaminant material fluids. Here it is used to associate with the established engineering for fluids.

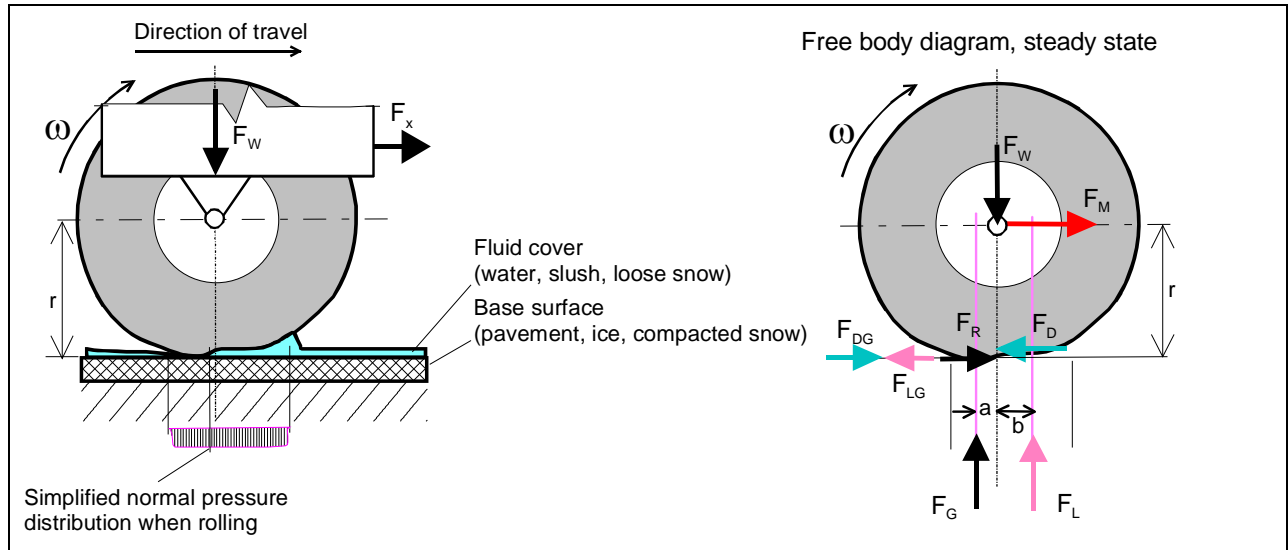

Figure E-8. Free-rolling friction measuring device wheel with fluid lift and drag.

The reaction force arising from the remaining ground contact, F_G , has a line of attack before and after the roll axis position, depending on the degree of planning. The sum of surface reaction forces is equal to the static weight carried by the wheel:

$$F_W = F_G + F_L \quad \text{Eq. E-24}$$

A torque-friction measuring device measures zero, as all terms in a summation of moments about the wheel axis reduce to zero.

The fluid lift force, F_L , has a reaction force, F_{LG} , in the contact surface between tire and ground. By taking the moment about the wheel axis,

$$F_L \cdot b = F_{LG} \cdot r \quad \text{Eq. E-25}$$

Rearranging the above equation, the horizontal fluid lift reaction force is as follows:

$$F_{LG} = \frac{b}{r} \cdot F_L \quad \text{Eq. E-26}$$

Summation of horizontal forces in equilibrium at steady-state yields:

$$F_M + F_R + F_{DG} - F_D - F_{LG} = 0 \quad \text{Eq. E-27}$$

With a fluid lift and drag acting on the tire, the horizontally measured force is determined as:

$$F_M = F_D - F_{DG} + F_{LG} - F_R \quad \text{Eq. E-28}$$

Substituting for F_{DG} and for F_{LG} using equation E-26, and simplifying,

$$F_M = \frac{t}{2 \cdot r} \cdot F_D + \frac{b}{r} \cdot F_L - F_R \quad \text{Eq. E-29}$$

Since $F_R = \frac{a}{r} \cdot F_G$ and $F_G = F_W - F_L$, then

$$F_R = \frac{a}{r} \cdot (F_W - F_L) \quad \text{Eq. E-30}$$

Substituting for F_R using equation E-30 in equation E-29, and simplifying,

$$F_M = \frac{t}{2 \cdot r} \cdot F_D + \frac{a+b}{r} \cdot F_L - \frac{a}{r} \cdot F_W \quad \text{Eq. E-31}$$

A force-friction measuring device with a de-coupled brake measures effects of displacement drag, fluid lift and planing.

The Nature of the Fluid Lift Force

Using Petroff's equation (given in Goodenow et al., 1968) for bearing lubrication, the fluid dynamic lift force can be expressed as:

$$F_L = k_L \cdot r \cdot \rho \cdot A_L \cdot V \quad \text{Eq. E-32}$$

where k_L is the fluid dynamic lift coefficient, ρ is the fluid mass density, A_L is gross tire-fluid contact area and V is the travel speed. The fluid dynamic lift coefficient depends on fluid viscosity and has a unit 1/time.

The propagation of planing is different for different tire designs; therefore, there is no fixed general relationship between the offset distances a and b from the vertical through the wheel axis. See the section titled "Fluid Planing with Different Tire Designs" for a discussion of planing contact area for different tires.

Horne and Dreher (1963) discuss two effects of water on tire-pavement interaction. One effect is hydroplaning, where inertia of the wheel and density properties of the fluid

Goodenow, G., T. Kolhoff, and F. Smithson. 1968. "Tire-Road Friction Measuring Systems—A Second Generation," Society of Automotive Engineers (SAE) Paper No. 680137, SAE.

Horne, W.B. and R.C. Dreher. 1963. "Phenomena of Pneumatic Tire Hydroplaning," NASA TN D-2056, National Aeronautical and Space Administration (NASA).

predominate. The other is thin film lubrication, where viscous properties of the fluid predominate.

The Moving Position of the Fluid Lift Force

A linear relationship between speed and the propagation of the planing front under high-pressure tires can be assumed. At full planing, the lift propagation length $l = L$. The speed at full planing is called the critical planing speed, V_C . The ratio of the propagation length to the full length is set equal to the ratio of measuring speed to critical planing speed. This can be expressed as follows:

$$\frac{l}{L} = \frac{V}{V_C} \quad \text{Eq. E-33}$$

or, solving for l ,

$$l = \frac{V}{V_C} \cdot L \quad \text{Eq. E-34}$$

To build a mathematical model of the fluid lift force, it can be assumed that the lift force is proportional to the separation area (length l , width w), the speed and the density of the fluid. It is also proportional to the curvature of the lift area (i.e., F_X or F_M the radius of the tire). Thus,

$$F_L = k_L \cdot w \cdot l \cdot r \cdot \rho \cdot V \quad \text{Eq. E-35}$$

Using equation E-34 to substitute for l and setting $\rho \cdot V = 1$, since density and speed effects are already included in V_C :

$$F_L = k_L \cdot w \cdot r \cdot L \cdot \frac{V}{V_C} \quad \text{Eq. E-36}$$

The group $w \cdot r \cdot L$ represents geometric tire properties and can therefore be included in a new tire coefficient, k_{PL} , such that:

$$F_L = k_{PL} \cdot \frac{V}{V_C} \quad \text{Eq. E-37}$$

This equation is a model equation to study the fluid lift as a dependent variable of travel speed and a set of constant parameters for a given tire configuration.

Fluid Lift Effects on the Tire–Surface Friction When Free Rolling

The fluid lift phenomenon reduces the contact area for supporting the tire–surface slip resistive forces. In a free-rolling mode the only resistive force is due to rolling resistance

when disregarding fluid displacement drag. The tire-rolling resistance coefficient of friction is as follows:

$$\mu_R = \frac{F_R}{F_G} \quad \text{Eq. E-38}$$

With no fluid lift, drag or brake, this equation represents the tire-rolling resistance slip friction coefficient on a clean surface. It is then a maximum attainable value, μ_{Rlim} . The tire-rolling resistance slip friction force is:

$$F_R = \mu_{Rlim} \cdot F_G \quad \text{Eq. E-39}$$

But in this scenario, F_G is equal to $F_W - F_L$, and therefore:

$$F_R = \mu_{Rlim} \cdot (F_W - F_L) \quad \text{Eq. E-40}$$

Substituting F_L with equation E-37 gives:

$$F_R = \mu_{Rlim} \cdot \left(F_W - k_{PL} \cdot \frac{V}{V_C} \right) \quad \text{Eq. E-41}$$

When considering a tire configuration with a constant normal load, the braking slip friction force equation can be rearranged and a factor, k_X , introduced, defined as:

$$k_X = \frac{k_{PL}}{F_W} \quad \text{Eq. E-42}$$

Then, the friction force equation becomes the following:

$$F_R = \mu_{Rlim} \cdot F_W \cdot \left(1 - k_X \cdot \frac{V}{V_C} \right) \quad \text{Eq. E-43}$$

At the boundary condition of full planing where $V = V_C$, k_X must be equal to one for F_R to be zero. Thus, the general braking slip friction force equation is:

$$F_R = \mu_{Rlim} \cdot F_W \cdot \left(1 - \frac{V}{V_C} \right) \quad \text{Eq. E-44}$$

or, expressed in terms of a fluid planing ratio, k_P , for a free-rolling wheel,

$$k_P = \frac{V}{V_C} \quad \text{Eq. E-45}$$

Therefore, by substitution,

$$F_R = \mu_{Rlim} \cdot F_W \cdot (1 - k_P) \quad \text{Eq. E-46}$$

Thus, the fluid lift or planing effects on the friction characteristics amount to a reduction of the slip friction force equal to a fraction of the maximum attainable friction force value for the surface that is proportional to the planing ratio.

For a force-measuring friction device, the measured friction, F_M , is equal to F_R when disregarding fluid displacement drag effects. Figure E-9 shows that the braking slip friction diminishes as the partial planing progresses, and that it is proportional to the speed and inversely proportional to the critical planing speed for the tire–surface combination. The V_C parameter is a constant parameter for the tire–surface combination.

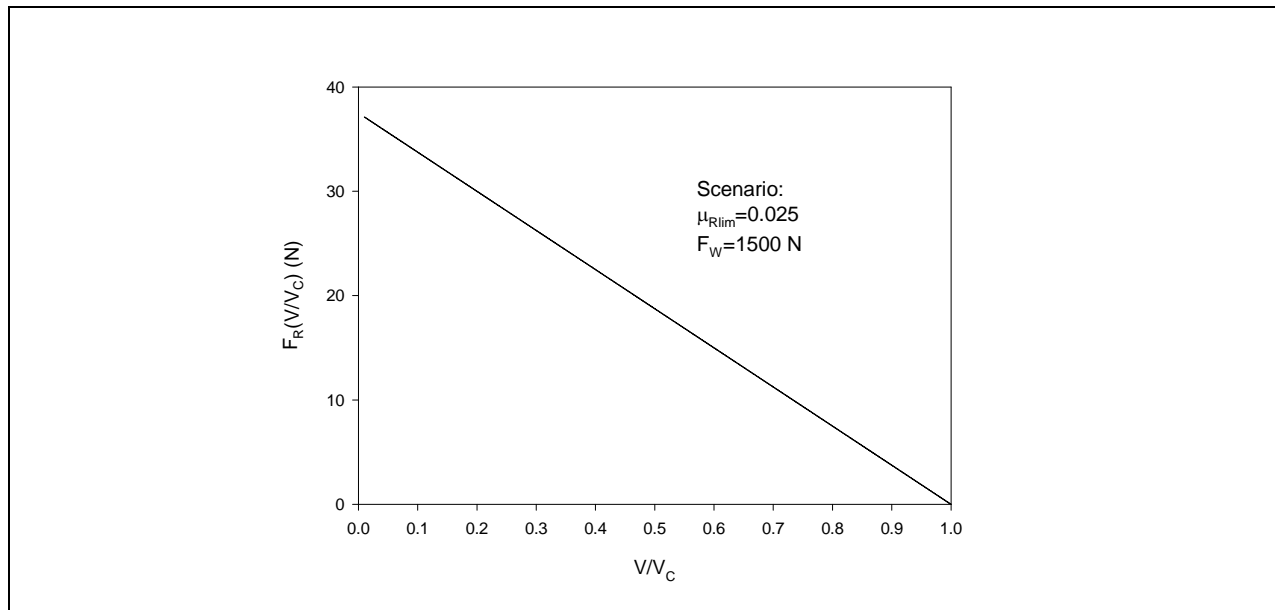

Figure E-9. A case of diminishing tire-rolling resistance force F_R as the planing propagates with increased speed.

Dynamic Contaminant Planing Propagation

The effect of dynamic contaminant planing is the loss of contact area for any braking slip friction to be generated. The tire configuration has a significant influence on the system of forces generated. To study this influence, two tire types will be selected that differ in the way they deform in the contact zone when planing. The position of the resultant fluid lift force will shift with travel speed and other parameters.

The tire is generally stronger along the sidewall than in the center of the contact patch. The weaker center area yields to the impingement forces of the fluid and allows it to penetrate under the center of the tire contact area. The penetration of fluid lifts the tire from the leading edge and separates the tire from the ground with the interspersed fluid. The sidewalls carry normal load to press the area along the sidewall to the ground.

Effectively, the fluid gets trapped in the center where the tire is weaker. If it is present in sufficient amounts, it can escape to the sides in texture voids of the surface. Otherwise, it will push its way through the whole length of the center portion of the contact area and leave the contact area at the center of the trailing edge. The fluid has then lifted the center portion of the tire contact area and reduced the net area of ground contact available for generating slip friction for braking. The same dry, powdery snow of the same moderate thickness may therefore affect the size of the net area of contact differently when present on good textured pavement versus smooth ice or a hard compacted snow base (negligible texture).

Research has shown that automotive-type tires remain longest in contact with the ground through the areas along the sidewalls, as the wedge of fluid penetrates the contact area at higher velocities. Automotive-type tires are models for many friction test tires. If the different categories of friction test tires have different force systems when planing, this must be accounted for when predicting forces for an actual automotive tire configuration.

Fluid Planing with Different Tire Designs

A fluid planing ratio can serve as a parameter to describe the intensity of fluid planing for a given device tire configuration and surface pair.

The fraction of contact patch area lifted versus the gross patch area is called a fluid planing ratio, k_p . A fluid planing ratio of 0.4 means that only 0.6 of the gross contact patch remains for slip friction braking. A fluid planing ratio of zero means that the whole gross contact patch is available for slip friction braking with the ground surface.

In figure E-10, a scenario with an automotive-type tire is depicted for different degrees of planing.

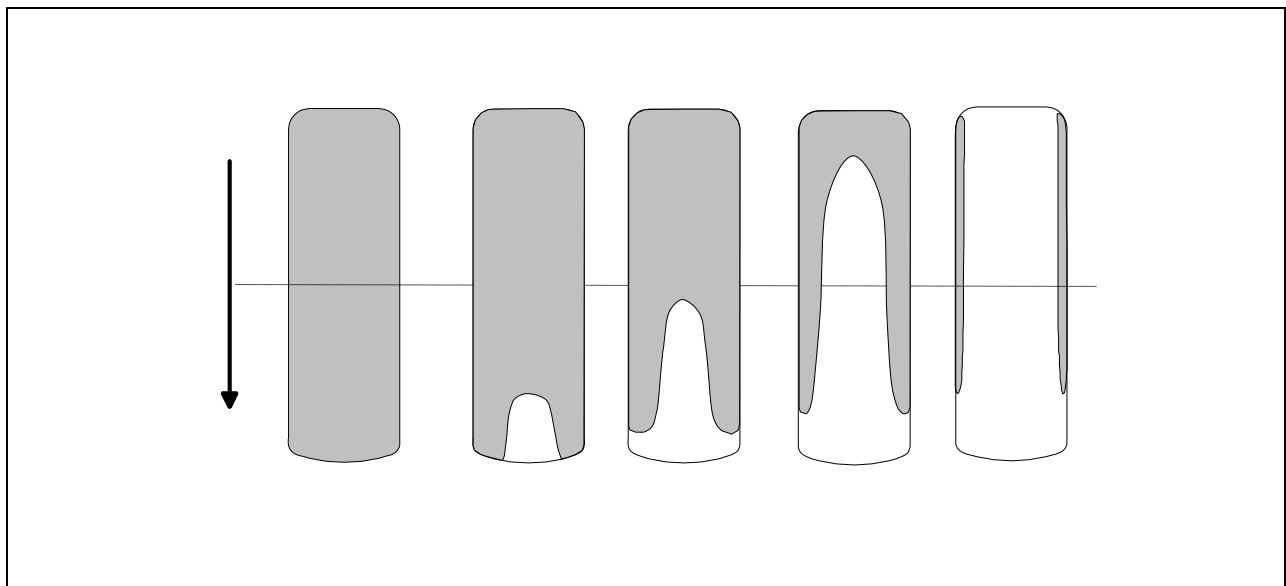

Figure E-10. Hydro- or aqua-planing of automotive tires.

It can be argued that an automotive tire will tend to keep the line of attack closer to a vertical plane.

Viscosity is a measure of the shear forces that a fluid can sustain when interspersed between opposing surfaces. Water has lower viscosity than slush or snow powder. The shear forces in the separation zone of the contact patch are therefore generally higher for snow powder than for water. The higher viscosity of snow powder also prevents it from escaping as quickly as water when there are escape voids or texture in the contact patch. Thus, the separation zone produced by the same thickness of water film and snow powder film will tend to yield a larger separation zone for snow powder than for water. In conclusion, tires are apt to lift more on snow powder than on water. The lift phenomenon is called fluid planing.

Critical Planing Speed

The critical planing speed is a function of fluid mass density, ρ , and contact pressure, σ , such that:

$$V_C = constant \cdot \sqrt{\frac{\sigma}{\rho}} \quad \text{Eq. E-47}$$

When V_C is determined for a tire configuration using water, the critical planing speed for a winter contaminant, $V_{Ccontam}$, can be estimated using the following:

$$V_{Ccontam} = constant \cdot \sqrt{\frac{\sigma}{\frac{\rho_{contamination}}{\rho_{water}}}} = constant \cdot \sqrt{\frac{\sigma}{\gamma}} \quad \text{Eq. E-48}$$

where γ is the specific gravity of the contaminant.

Resistive Forces from Fluid Displacement Drag on Rigid Base Surfaces

The fluid displacement drag on the tire is given by the following:

$$F_D = \frac{1}{2} \cdot C_D \cdot \rho \cdot A_D \cdot V^2 \quad \text{Eq. E-49}$$

where C_D is the fluid drag coefficient, ρ is the fluid mass density, A_D is the tire-fluid contact area in the normal vertical plane and V is the traveling velocity. The drag force is not considered to have a significant vertical component. The fluid lift stems from the tire rolling over the fluid, which escapes under compression in texture voids or gives rise to planing.

The drag coefficient is the ratio of resistance over dynamic pressure multiplied by the maximum cross-sectional area of the body, A_D . There is a need to research drag coefficients for high pressure friction tester tires and high pressure heavy vehicle type tires for varying depths of contaminants.

For viscous planing of a very high pressure tire, the area A_D is a constant:

$$A_D = w \cdot t \quad \text{Eq. E-50}$$

where w is the gross width of the tire footprint and t is the contaminant fluid layer thickness.

As shown in figure E-11, the frontal area for drag can be reduced as a result of the buckling of the tire. Some contaminant may then be trapped to flow under the tire rather than be displaced to the sides. The effective area, A_D , for the automotive tire type planing can be modeled as:

$$A_D = w \cdot t \cdot \left(1 - \frac{1}{2} \cdot k_p\right) \quad \text{Eq. E-51}$$

where k_p is the planing factor.

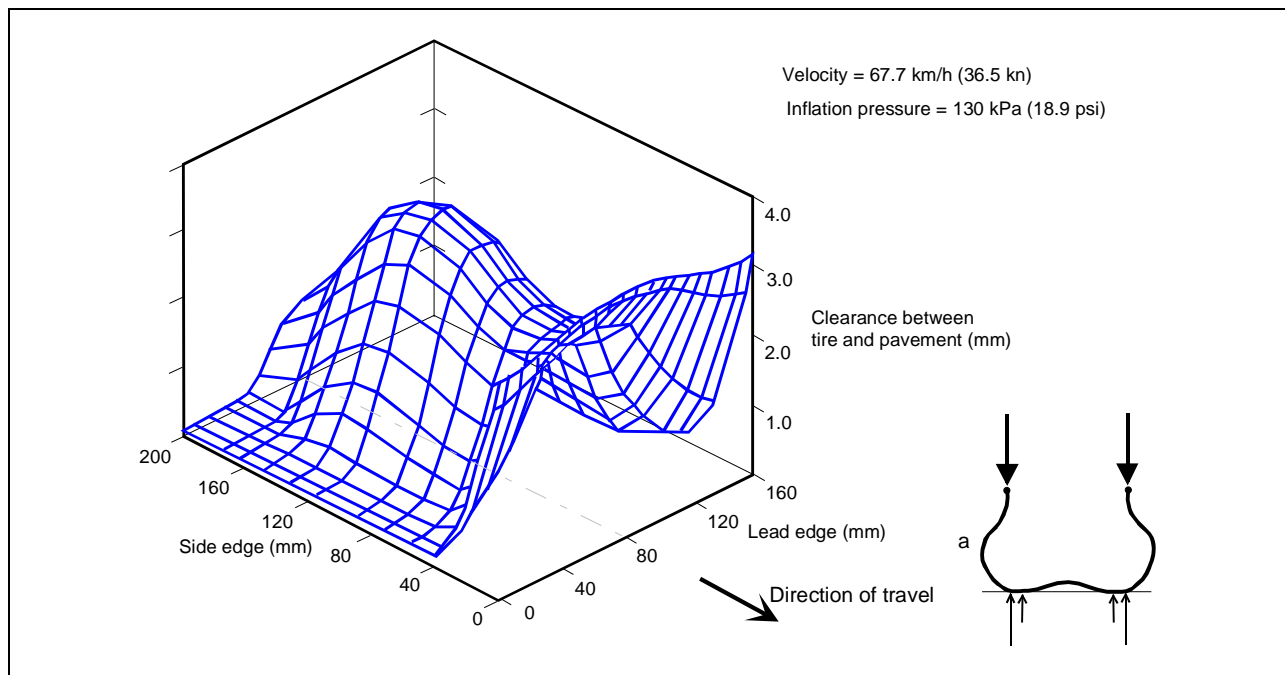

Figure E-11. Fluid film distribution in automotive tire footprint.

Results of sample calculations for the drag force are shown in figure E-12. A value of $C_D = 0.4$ has been assumed for the calculations. As can be expected, the forces are smaller for the lower density fluid and proportional to the densities. For full fluid planing, the forces are half the values of the non-planing values. This particular planing factor definition can be applied only to automotive tire types.

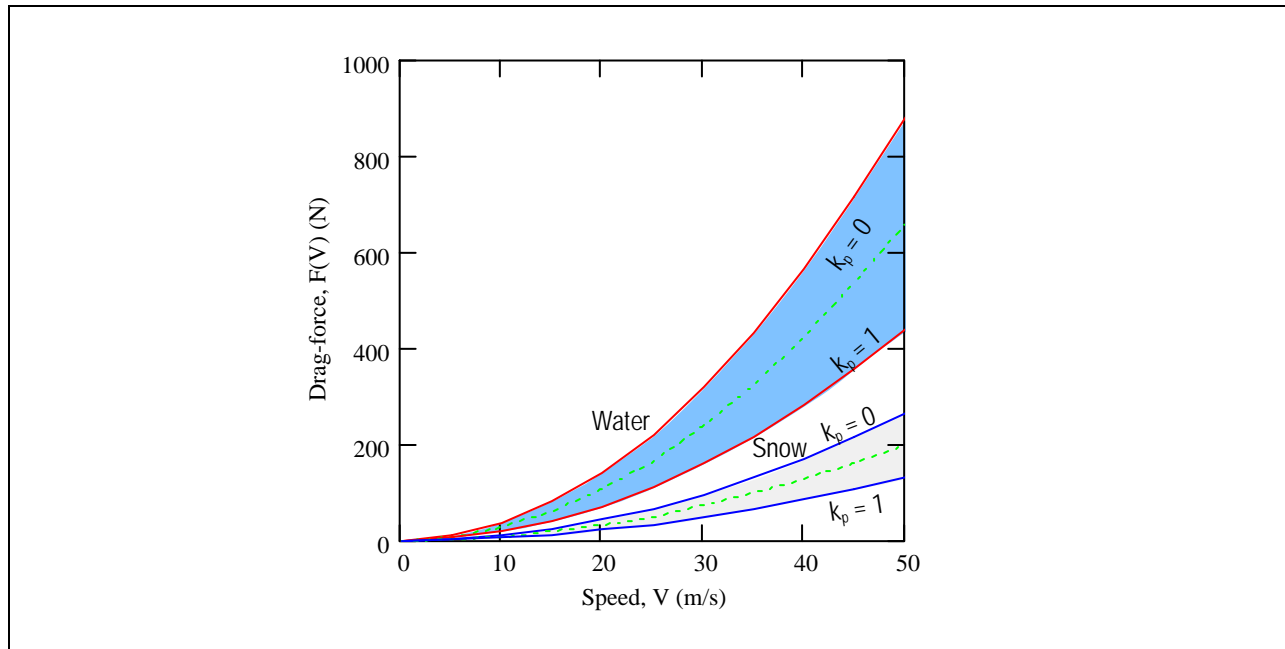

Figure E-12. Sample theoretical fluid displacement drag force for the ASTM E 1551 tire on snow.

SUMMARY OF MECHANICS OF TIRE–SURFACE FRICTION

Given that the objective of friction measuring devices is to report braking slip friction, the dynamic influences of winter contaminants in liquid, plastic or particle form introduce errors in the reported friction values. These adverse dynamic effects contribute differently to the reported friction values for various types of devices.

Generally, the adverse effects grow with increasing travel speed and the increasing deposit depth and density of the contaminate.

The braking slip friction force, F_B , depends on the slip speed and travel speed where adhesion and hysteresis constitute the principal mechanisms of friction.

When planing occurs, the effective contact area for generating braking slip friction forces is gradually reduced with increasing travel speed.

The displacement drag force, F_D , depends on the squared velocity and increases rapidly with accelerating travel speed. The drag term grows and the braking slip friction term diminishes in relative and absolute terms.

The rolling resistance force due to fluid lift effects, F_L , will increase on surfaces with loose contaminants, as it combines with vertical components of compacting resistance forces.

The fluid forces are closely related to tire geometry, tire carcass design, inflation pressure, and weight carried by the wheel. Different tire types exhibit different behaviour with planing.

The speed dependency of the error terms indicates that a measuring speed limit may exist in order to report below acceptable errors for a given surface material, contaminant type and deposit depth. In general, the error of the reported friction increases with increasing measuring speed for both a force- and torque-measuring friction device. To minimize the error, measuring should be done at low speeds if there is a possibility for significant contaminant deposit depths.

When there is no significant deposit depth of a fluid or loose winter contaminant on the base surface, the difference between reported friction values from a force- and torque-measuring friction device using the same tire configuration will be the tire-rolling resistance value.

MODERN TIRE-PAVEMENT FRICTION MODELS

Penn State, PIARC and Rado Models

The World Road Association conducted an exemplary field investigation in 1992 (Wambold et al., 1995). In a large international measurement experiment, wet pavement was studied across a wide variety of pavement materials for highways, including some runways. The objective was to harmonize friction and texture measurement devices. Several important outcomes have been reported from that experiment. One is that macro-texture is the principal reason for the speed dependency of friction. Harmonization of the friction measuring devices participating in the experiment was achieved with the support of texture information. The harmonized friction measure was therefore proposed as a two-parametric International Friction Index (IFI): a friction number associated with a reference slip-speed value and a speed number associated with the slip-speed gradient of friction.

The participating friction measuring devices measured friction at different slip values. The successful harmonization resulted when the measured friction values were adjusted to a common slip-speed value of 37 mi/hr (60 km/hr). These adjustments were calculated with an exponential equation derived from what is known as the Pennsylvania State University model. It is widely used to predict friction at speeds other than the measured speed for a surface. The model has the following form:

$$\mu(V) = \mu_0 \cdot e^{\left(\frac{-V}{V_0}\right)} \quad \text{Eq. E-52}$$

where μ_0 is the zero intercept and V_0 is an exponential constant.⁴ Both parameters are valid for a surface only and can be determined by measuring friction at several speeds.

Wambold, J.C., C.E. Antle, J.J. Henry, and Z. Rado. 1995. "International PIARC Experiment to Compare and Harmonize Texture and Skid Resistance Measurements," AIPCR-01.04.T.

⁴ The original Penn State Model uses so-called skid numbers for friction coefficient and the term $100/PNG$ instead of V_0 as used here. PNG is a percent normalized gradient.

In the derived PIARC model, the zero intercept of this equation is replaced by a constant friction value at an arbitrarily chosen reference slip speed of 37 mi/hr (60 km/hr) and another exponential term.

$$\mu(S) = \mu(60) \cdot e^{\frac{60-S}{S_p}} \quad \text{Eq. E-53}$$

The slip speed of 37 mi/hr (60 km/hr) was chosen as a representative median value for road vehicles during emergency braking. The value of friction at that speed is $\mu(60)$.⁵ The slip-speed value is a parameter of the exponential term. A second parameter of the exponential term is the so-called Speed Constant, S_p , which is closely related to measurements of macrotexture for the same surface. A sample graph produced with equation E-53 is shown in figure E-13.

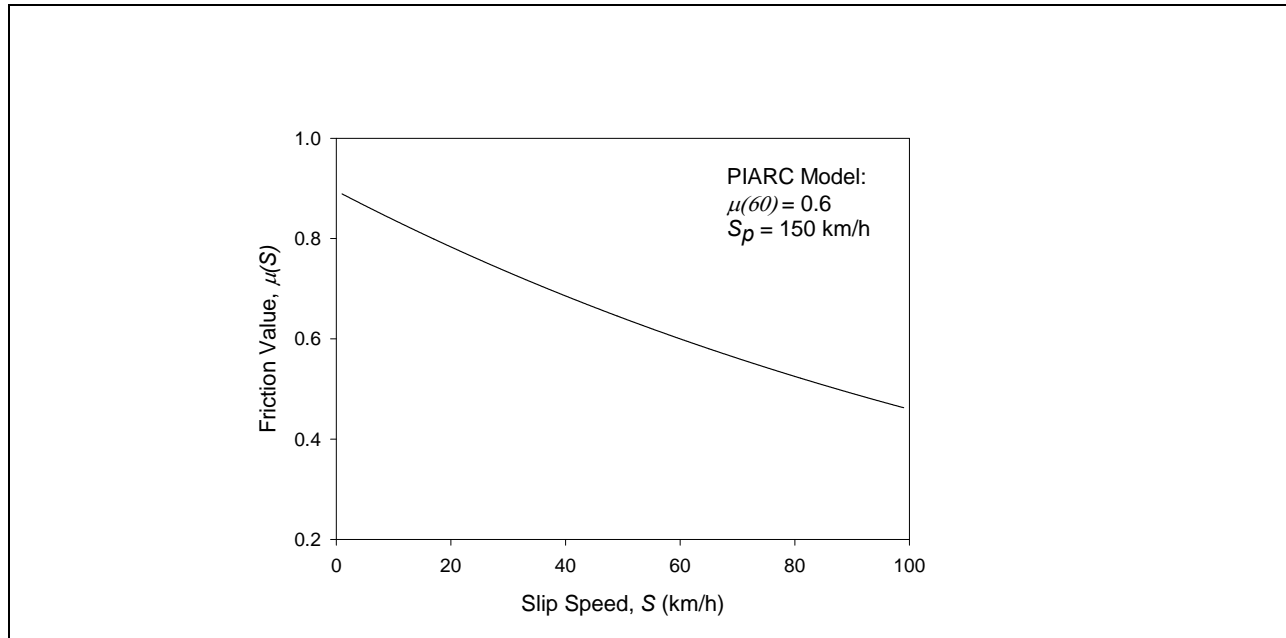

Figure E-13. A sample plot of friction model for the International Friction Index (IFI).

When the IFI parameters for a surface are known, the friction value can be calculated for all slip speeds for the surface.

For braking slip friction, the basic friction model of Amontons can be replaced with the following friction model:

$$F(S) = \mu(60) \cdot e^{\frac{60-S}{S_p}} \cdot N \quad \text{Eq. E-54}$$

⁵ The original model uses the notation F for friction coefficient instead of μ as used here to differentiate between force and coefficient.

This equation is valid for wet pavement only. It has successfully captured the commonly observed influences of texture and slip speed for a device tire configuration-surface pair. For the same surface, another device would have another set of parameters, $\mu(60)$ and S_p .

Inspired by PIARC's success, we should continue our quest for more precise friction models for other tire-surface pairs. Indications are that one mathematical model may not be able to describe all the different tire-surface pairs found on roads and highways during winter.

A potential problem of extending the PIARC model to another hard surface, such as rough ice, is the lack of texture measurement devices that can be used on ice. The gradient of the friction curve cannot be determined from texture devices. Additionally, the surface rather than the tire becomes the sacrificial part of the tire-surface pair. The texture effect of a sacrificial surface is usually regarded as insignificant or nil.

Another outcome of the PIARC experiment seems to have the potential to rectify this problem: combining the logarithmic friction model with variable-slip measuring techniques. One of the researchers at Pennsylvania State University who analyzed the experiment results, came up with a good fit for a new friction model. The model is an implementation of a three-parameter log-normal equation, often referred to as the Rado model.

This model captures the influence of the tire design and material in addition to texture, slip speed and measuring speed. The model is valid for wet pavement as it was derived from such a database. It has the following form:

$$\mu(S) = \mu_{peak} \cdot e^{-\left(\frac{\ln \frac{S}{S_c}}{C^2}\right)^2} \quad \text{Eq. E-55}$$

where μ_{peak} is the maximum or peak friction coefficient value measured during a controlled, linearly ramped braking from free rolling to locked wheel at a constant measuring speed. S_c is the slip speed at which the maximum friction occurred and C^2 is a shape factor related to texture measurements in a slightly different manner than the speed constant, S_p , of the IFI. All three model parameters are determined by measurements of the ground friction measurement device using variable-slip technique. The friction value at other slip speeds can therefore also be calculated with this model.

A graphical presentation of the model is shown in figure E-14. The maximum friction value is 0.75, the slip speed at which it occurred is 12 mi/hr (20 km/hr) and the shape factor is 1.05.

A notable difference between the PIARC and Rado models is found at low slip speeds. Figure E-15 shows the two graphs superimposed: the Rado model is the transient phase when the brakes are first applied up to some slip, then the PIARC model follows as the speed of the vehicle slows. The PIARC model is the steady-state value of friction. In a stopping situation, the transient part happens so quickly that only the steady-state, the PIARC Model, needs to be used. However, when antilock braking systems (ABS) are used, both models must be used to evaluate stopping and stopping distance.

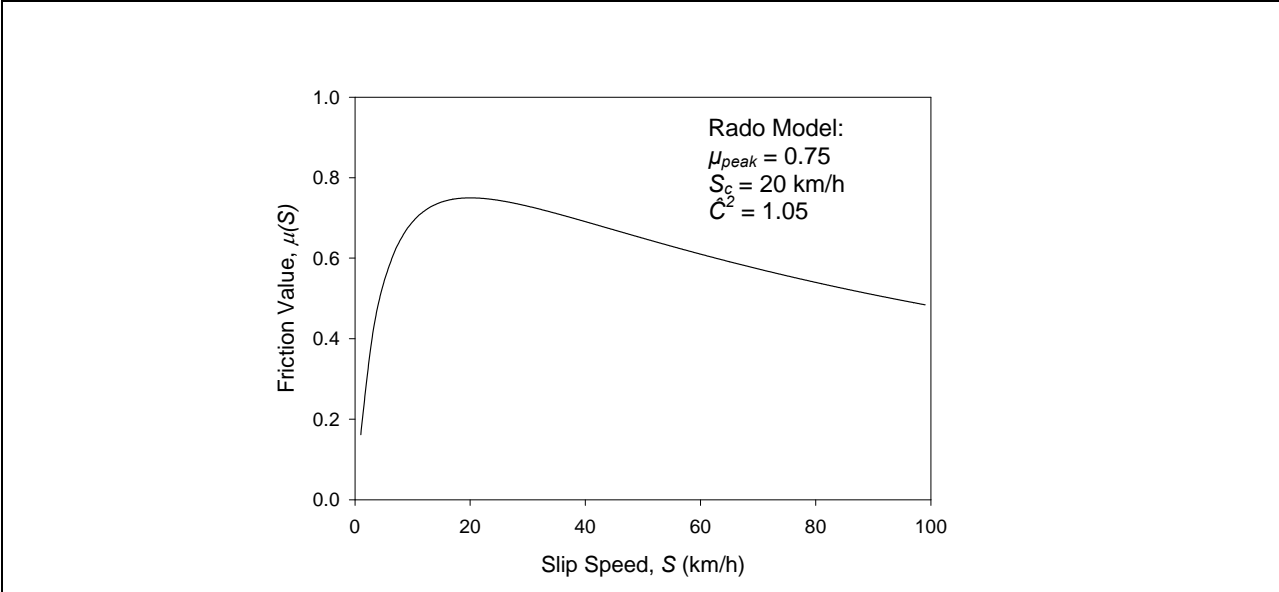

Figure E-14. A sample Rado model plot.

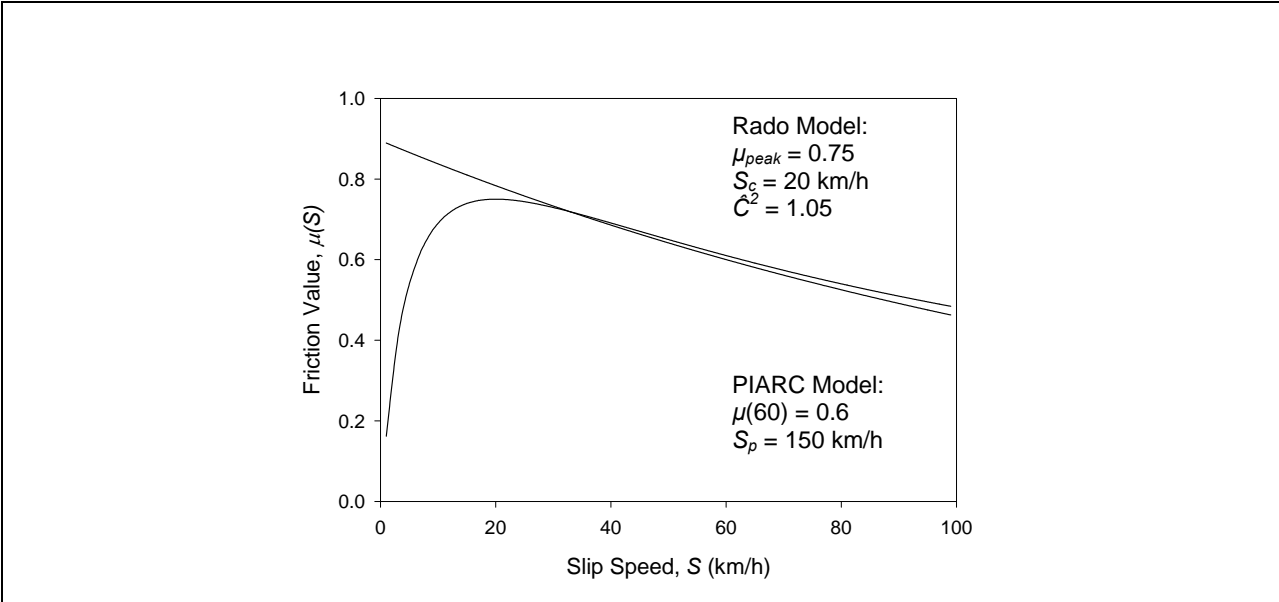

Figure E-15. A sample comparison between PIARC and Rado friction models.

The PIARC model and its IFI are primarily intended for long-term monitoring of the pavement for budgeting renewal of the surface when polished or worn to unacceptable levels. The Rado model is intended for the prediction of braking performance. Automotive ABS brake systems operate on the initial rising part of the friction-slip speed curve of the Rado model. This part of the curve is often called the tire influence segment. Beyond the maximum friction value, the curve has a surface influence segment.

ABS and other automatically modulated brakes are not designed to operate beyond the maximum friction point. The braking systems operate on the tire influence segment of the Rado model friction curve.

Now we have a model that can predict the braking force, F , of a single wheel at a constant travel speed:

$$F(S) = \mu_{peak} \cdot e^{-\left(\frac{\ln \frac{S}{S_c}}{C^2}\right)^2} \cdot F_W \quad \text{Eq. E-56}$$

Preliminary findings of the Joint Winter Runway Friction Measurement Program suggest that the Rado model parameters—maximum friction, slip speed at maximum friction and shape factor—are unique for a tire–surface pair. Thus, surfaces may be classified with this technique.

In summary, the PIARC Model is best for use with fixed-slip devices and varying measuring speeds. The Rado Model is for use with fixed measuring speed and varying slip speed. When the two models are combined, three-dimensional models are obtained as described in the following section.

Three-Dimensional Modeling of Tire–Surface Friction

Since travel speed and slip speed have been treated separately by different friction models as two independent variables, it would be desirable to have a combined three-dimensional friction model including travel and slip speeds as variables.

Bachmann (1998) has found that repeated runs with variable-slip devices can provide data for deriving three-dimensional friction models with travel and slip speeds as variables. As can be seen from figure E-16, the series of measurements almost constitute a surface plot of friction. The curves are measured with a treaded automotive tire on dry, concrete pavement.

It is more practical to use slip ratio rather than slip speed as an independent variable to view the surface plot as a full area cover. Since the upper limit slip speed at any travel speed equals the travel speed of the device, plotting with slip speed on one axis would generate a triangular shape plot projected in the speed plane.

Bachman, T. 1998. “Wechselwirkungen im Prozess der Reibung zwischen Reifen und Farbahn, VDI Reihe 12 Nr. 360.

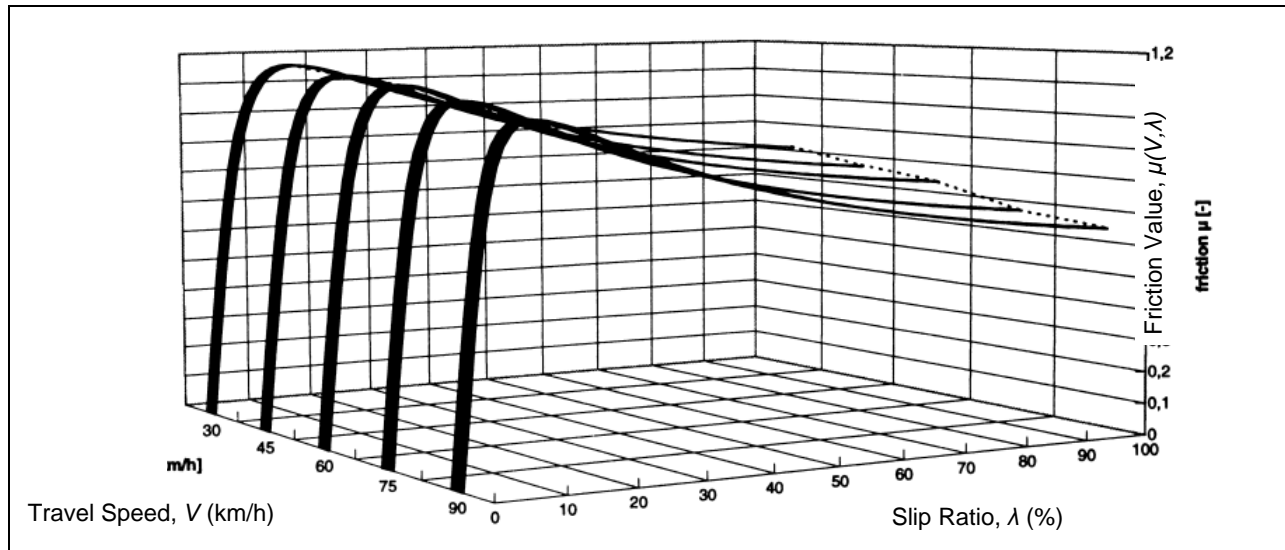

Figure E-16. Series of variable-slip measurements with an automotive tire at different measuring speeds on dry concrete pavement [6].

Based on the characteristic shapes of the curves in figure E-16, it is conceivable that three-dimensional plots of standard types of measuring tires may be produced. This can be used as documentation of the typical friction speed characteristics of a tire as an instrument sensor for different surface types and conditions.

Although research strongly indicates that braking slip friction can be presented in a three-dimensional manner as shown, researched and documented universal three-dimensional mathematical models are not yet available unless the Rado and PIARC models are combined.

STANDARD TIRE-SURFACE FRICTION MEASUREMENT

The International Friction Index (IFI)

The World Road Association conducted the *International PIARC Experiment* in September and October 1992. Forty-seven different measuring systems surveyed 54 sites, encompassing a wide variety of pavement types on roads and airfields in Belgium and Spain. The systems measured 67 different parameters (33 texture parameters and 34 friction parameters). The results of the experiment were presented in Montreal in 1995.

The World Road Association had recognized that methods and systems used throughout the world for measuring texture and skid resistance vary significantly, causing barriers for much-needed international information exchange and comparisons. It was necessary to convert results produced by different devices to a common scale. The PIARC Technical

Committee C1 on Surface Characteristics decided to conduct an experiment to see whether harmonization could be achieved. The data collected and analyzed enabled an international scale of friction values called IFI to be defined. The IFI is now an ASTM standard (E 1960-98) and an ISO standard (13473-1).

Since wet pavement friction is speed-dependent, the PIARC model incorporates macro-texture measurements to enable the side-force, fixed-slip, and locked-wheel types of friction measurements to be related. The IFI can be calculated from the results of any friction measurement combined with a macro-texture measurement that predicts the speed gradient of the friction.

The IFI consists of two parameters: F_{60} and S_p . F_{60} is the harmonized estimate of the friction at 37 mi/hr (60 km/hr) and S_p is the speed constant. Friction values can be calculated for any slip speed.

The PIARC model and IFI therefore represent universal engineering tools that are valid for braked tires interacting with wet pavement types such as those encountered on highways. It was found that friction devices could be harmonized. The reference of harmonization was the average performance of all participating devices. The average performance is represented by a mathematical equation; a decaying exponential called the Golden Curve. Each device has a calibration factor to this Golden Curve at the speed of harmonization (37 mi/hr [60 km/hr] slip speed).

Calibration constants were worked out for all of the participating devices and are published in the report of the experiment. The calibration constants used with the corresponding friction devices enable the Golden Curve to be recreated for surfaces, thus allowing secondary calibrations of new equipment to be performed or friction values obtained with one device to be translated to the measuring units of another calibrated device.

The Harmonization Procedure

The PIARC harmonization procedure is as follows.

1. The speed constant is calculated using a texture measurement of the surface. The equation used is:

$$S_p = a + b \cdot Tx \quad \text{Eq. E-57}$$

where Tx is a texture measurement and a and b are harmonization constants for the texture measuring device determined in the international experiment.

2. The friction measurement is adjusted to the harmonization slip speed of 37 mi/hr (60 km/hr) using the following equation:

$$\mu(60)_{device} = \mu(S)_{device} \cdot e^{\frac{S-60}{S_p}} \quad \text{Eq. E-58}$$

where S is the slip speed of the measurement and $\mu(S)_{device}$ is the measured friction value by the device. For a fixed-slip friction measuring device, the slip speed is the measuring speed multiplied by the slip ratio.

3. The harmonized friction value at 60 km/h slip speed is then calculated using the equation:

$$\mu(60)_{harmonized} = A + B \cdot \mu(60)_{device} \quad \text{Eq. E-59}$$

when the measuring tire has a blank tread, or

$$\mu(60)_{harmonized} = A + B \cdot \mu(60)_{device} + C \cdot Tx \quad \text{Eq. E-60}$$

when the measuring tire tread is ribbed or has a pattern. A , B and C are calibration constants for the friction device determined in the international experiment. The calibration constants are regression constants.

4. The International Friction Index is then reported as $IFI_{60}(\mu(60)_{harmonized}, S_p)$. The PIARC Model can also adjust the IFI to another slip reference value using the following equation:

$$\mu(S)_{harmonized} = \mu(60)_{harmonized} \cdot e^{\frac{60-S}{S_p}} \quad \text{Eq. E-61}$$

where S is the slip speed for which a friction value is desired. For instance, the IFI friction value at 90 km/h, would be

$$\mu(90)_{harmonized} = \mu(60)_{harmonized} \cdot e^{\frac{60-90}{S_p}} = \mu(60)_{harmonized} \cdot e^{\frac{-30}{S_p}} \quad \text{Eq. E-62}$$

The IFI is then reported as $IFI_{90}(\mu(90)_{harmonized}, S_p)$.

The management beauty of the IFI is that regulations can be made stipulating IFI parameters, which are universal (i.e., no tie to a particular friction device). But a friction device must have calibration constants determined, as demonstrated by figure E-17. It is natural that they initially come with the device as part of the documentation from the manufacturer, as is the common industry practice by other instrument manufacturers.

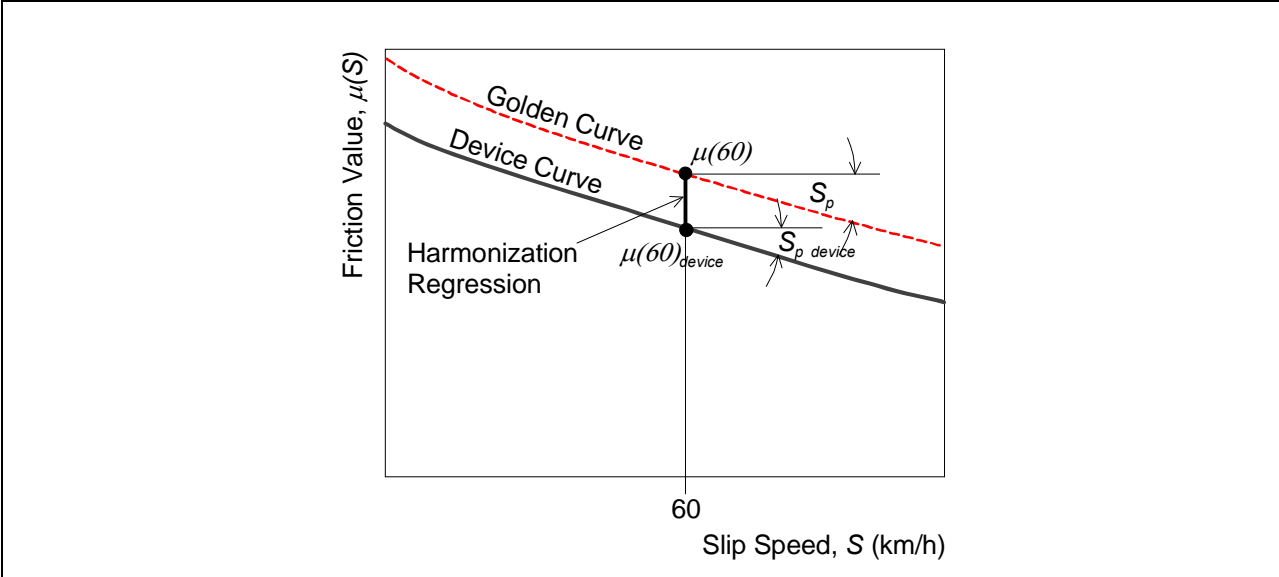

Figure E-17. Calibration constants for IFI are taken at a harmonizing slip speed of 37 mi/hr (60 km/hr). The reference curve is named the Golden Curve. It is an average of all participating devices in the 1992 experiment.

LIST OF SYMBOLS AND ABBREVIATIONS

A	Calibration constant for the International Friction Index
A_D	Area in the vertical plane associated with contaminant deposit displacement drag
A_L	Contact area between a tire and a fluid
A_R	Real contact area between a tire and a surface
A_S	Area of shearing contact between a tire and a surface
B	Calibration constant for the International Friction Index
C_D	Coefficient of displacement drag
CV	Coefficient of variation
\hat{C}	Shape factor in the Rado friction model (log normal)
E	A force, or a sum of forces, that constitute an error term in a measured braking slip force
F	Force
F_B	Force due to braking slip friction
F_D	Force resulting from positive displacement of fluid or plastic material in the frontal area of a tire
F_{DG}	Reaction force in the tire–surface area due to contaminant displacement drag
F_E	Resultant dynamic contaminant deposit force
F_G	Reaction force from the ground
F_L	Lift force due to dynamic fluid viscous resistance (Petroff's equation)
F_{LG}	Reaction force in tire–surface contact area due to dynamic fluid lift or compacting lift
F_M	The horizontal force measured by a friction measuring device at the wheel axis
F_{MD}	Reaction force at a wheel axis due to contaminant displacement drag
F_R	Force due to pneumatic tire rolling resistance
F_S	Resultant resistive reaction force in the tire–surface contact area
F_W	Applied vertical force on a wheel axis, equal to a device mass multiplied by the gravity constant, or a controlled, vertically applied force
F_X	Force applied at the wheel axis in direction of the x-axis (direction of travel)
I	Angular moment of inertia
L	Length
M	Moment
M_B	Applied brake moment about a wheel axis
MTD	Mean texture depth
S	Slip speed
S_C	Critical slip speed value in a Rado friction model (log normal friction model)
S_P	Speed number of the PIARC friction model or the International Friction Index
$StdErr$	Standard Error
$StdDev$	Standard deviation

T_M	The moment measured by a friction measuring device about the wheel axis
T_X	Texture measurement, generic
V	Travel speed
V_B	Tangential speed of a braked wheel in the tire–surface contact area
V_C	Critical planing speed
V_0	Speed constant
a	<ol style="list-style-type: none"> 1) Horizontal distance between a point of application of the vertical ground reaction force and vertical line through the wheel axis 2) Calibration constant for texture measurement with the International Friction Index 3) Zero intercept parameter for exponential friction model 4) Longitudinal acceleration
b	<ol style="list-style-type: none"> 1) Horizontal distance between vertical through the wheel axis and point of application for a dynamic lift force 2) Calibration constant for texture measurement with the International Friction Index 3) Speed parameter for an exponential friction model
c	Vertical distance between a tire–surface contact plane and a point of application for a resultant dynamic contaminant deposit force
g	Gravitational acceleration constant
k_L	Dynamic fluid lift coefficient
k_P	Fluid planing factor
k_{PB}	Braked wheel planing ratio
k_{PL}	Dynamic fluid lift coefficient including deflected tire radius and tire–surface contact area
k_{VD}	Vertical displacement factor
l	Length of a tire–surface contact area
n	Number of data points or measurements, sample size
r	Deflected tire radius
t	Contaminant deposit thickness
w	Width of the tire–surface contact area
α	Angle
λ	Slip ratio, S/V
γ	Specific gravity
μ	<ol style="list-style-type: none"> 1) Friction coefficient as the ratio of a horizontal force to a vertical force in the tire–surface contact area. 2) A reported friction value.
μ_{10}, μ_{100}	Average coefficient of friction over a 10 m or 100 m measured distance
μ_B	Braking slip friction coefficient, F_B/F_W
μ_{peak}	A maximum or peak friction coefficient value in a variable-slip measurement

μ_R	Tire-rolling friction coefficient, F_R/F_W
ρ	Contaminant fluid or particle mass density
σ	Normal stress or contact pressure
σ_S	Normal stress in the shear area of a tire–surface contact patch
τ_{ult}	Ultimate shear stress of a surface material
ν	Dynamic viscosity
ω	Angular velocity
ω_B	Angular velocity of a braked wheel
<i>ABS</i>	Antilock Braking System
<i>ASTM</i>	ASTM International
<i>IFI</i>	International Friction Index
<i>ISO</i>	International Organization for Standardization
<i>JB</i>	James Brake Index
<i>JWRFMP</i>	Joint Winter Runway Friction Measurement Program
<i>NASA</i>	National Aeronautics and Space Administration
<i>PIARC</i>	Permanent International Association of Road Congresses (The organization has changed its name to World Road Association (PIARC))
<i>SAE</i>	Society of Automotive Engineers