

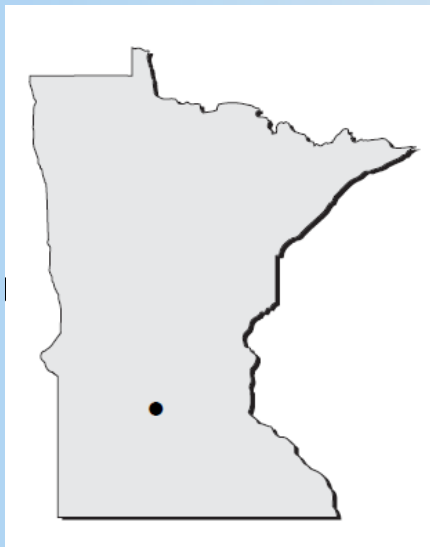

Minnesota Airport System Pavement Evaluation 2010 Update



Hutchinson Municipal Airport
(HCD)

Hutchinson, Minnesota

Prepared for:

Office of Aeronautics
Minnesota Department of Transportation
222 East Plato Boulevard
Saint Paul, MN 55107
(800) 657-3922

December 2010

TABLE OF CONTENTS

	<u>Page No.</u>
INTRODUCTION	1
Project Background.....	1
Pavement Management Approach	1
Scope of Work	2
PROJECT APPROACH	3
Update Pavement Inventory.....	3
Pavement Network Definition	3
Naming Scheme	3
Pavement Evaluation	4
Distress Types	6
PCI Results.....	7
Projected PCI	11
RECOMMENDATIONS	12
Near Term Maintenance	12
Major Rehabilitation	12
Federal Guidelines	13

APPENDICES

Appendix A.....	Sample Unit Maps
Appendix B.....	Pictures
Appendix C.....	PCI Distress Report
Appendix D.....	Distress Identification
Appendix E.....	Maintenance and Major Rehabilitation Policies
Appendix F.....	Localized Maintenance Recommendations
Appendix G.....	Maintenance Repair Guidelines

LIST OF TABLES

	<u>Page No.</u>
Table 1. Branch definition	4
Table 2. PCI distress types.....	7
Table 3. PCI section summary table	10
Table 4. Recommended 5-year major rehabilitation plan.....	13

LIST OF FIGURES

	<u>Page No.</u>
Figure 1. Pavement condition life cycle	2
Figure 2. Network definition map.....	5
Figure 3. PCI rating scale and repair levels	6
Figure 4. PCI map.....	8
Figure 5. Condition distribution.....	9
Figure 6. Area-weighted PCI by pavement use	9
Figure 7. Projected PCI by percent area	11

INTRODUCTION

Since 1995, Federal grant assurances have required that, in order to continue receiving Federal funding, airports implement a pavement maintenance-management program for any pavement constructed or repaired using Federal money. To help individual airports meet this grant assurance and improve the statewide airport system, the Minnesota Department of Transportation (Mn/DOT) Office of Aeronautics contracted with Applied Research Associates, Inc. (ARA) to provide pavement evaluation and management inspections at local airports. This report contains the results of the 2010 pavement inspections at Hutchinson Municipal Airport (HCD).

Pavement conditions were assessed using the Pavement Condition Index (PCI) procedure, outlined in Federal Aviation Administration (FAA) Advisory Circular (AC) 150/5380 and ASTM D5340 for airfield pavements. The PCI was developed to provide a numerical value indicating overall pavement condition that correlates well with the ratings of experienced engineers. During a PCI survey, visible signs of deterioration within a selected sample unit are recorded and analyzed. The final calculated PCI value is a number from 0 to 100, with 100 representing a pavement in excellent condition. The PCI evaluation makes possible forecasting of future deterioration and allows for accurate projections of maintenance and rehabilitative needs.

The data collected during this project were entered into the MicroPAVER pavement management software program developed by the U.S. Army Corps of Engineers, Construction Engineering Research Laboratory. The capabilities of MicroPAVER were utilized to meet the following project objectives:

- Update and store pavement inventory and condition data.
- Develop models to predict future conditions.
- Develop maintenance and repair recommendations.
- Report the results at the individual and statewide level.

Project Background

The general aviation airfields throughout Minnesota play a key role in the movement of goods and services with an estimated overall economic impact of \$1.6 billion. Mn/DOT realizes the value in maintaining the paved facilities by implementing and updating an airport pavement management system (APMS). An APMS provides guidance for decisions regarding pavement maintenance and repair policies at an airport and can identify short-, medium-, and long-term rehabilitation needs. Mn/DOT typically has performed PCI inspections at each airport on a 3-year cycle so that the most recent pavement condition data in the APMS reflect the field conditions.

Pavement Management Approach

The main goal of any pavement management system is to identify pavements that will receive the most benefit from an optimally timed repair. By projecting the rate at which the pavement condition will deteriorate, the optimal time for applying treatments can be

determined. Typically, the optimal repair time is the point at which a gradual rate of deterioration begins to increase to a much faster rate, as illustrated in figure 1. It is critical to identify this point in time to avoid higher rehabilitation costs caused by excess deterioration. Figure 1 also shows conceptually how it is cheaper to maintain pavements that are in good to fair condition, rather than wait until the poor condition requires an expensive reconstruction treatment.

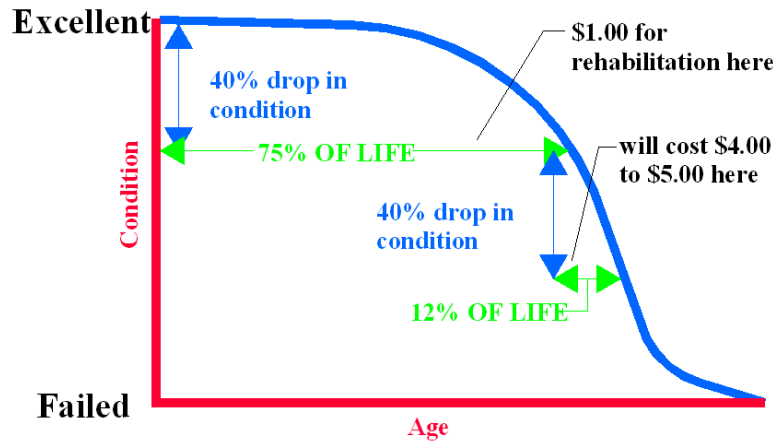

Figure 1. Pavement condition life cycle.

Often, the identified needs will cost more than the available budget and will need to be prioritized. The APMS can measure the impact of a limited budget scenario by projecting the future condition of deferred projects. Ultimately, the APMS will provide Mn/DOT and the airport a planning tool that can help identify pavement needs, optimize the selection of projects and treatments over a multi-year period, and understand the consequences of these plans.

Scope of Work

Beginning in 2008, Mn/DOT retained ARA for 3 years to update the APMS for 102 of Minnesota's publicly owned general aviation airports. Mn/DOT identified approximately 1/3 of the airports to be inspected each year and provided the available construction history information and existing MicroPAVER databases for each airport. ARA coordinated the PCI inspections with each airport. After the field work was completed, ARA updated the MicroPAVER database and computer-aided drafting (CAD) map for each airport. MicroPAVER was then used to develop a maintenance work plan based on current distresses. In addition, a 5-year projection identifying work levels of recommended pavement repair needs was prepared at the state level for the various stakeholders to use as a planning tool. Individual reports, such as this one, were prepared for each airport documenting the results of the pavement inspections. A statewide analysis report was prepared based on that inspection year's airports. The airport maps were linked to the MicroPAVER database to allow for geographic information system (GIS) viewing of data. Also, training was provided on the use of the MicroPAVER software and PCI procedure.

PROJECT APPROACH

Update Pavement Inventory

The pavement inventory at HCD represents the airfield pavements that are intended for aviation-related traffic. The main objective in updating the pavement inventory was to determine the year of the construction (or most recent overlay), the limits of the project, and the surface type for each pavement area based on construction history. When available, Mn/DOT provided this information for the pavement-related projects for areas not already included in previous inspections. ARA then used this information to update the pavement section definitions on the CAD map and MicroPAVER database based on project limits, surface type, layer properties, traffic patterns, and overall condition.

Pavement Network Definition

The construction history information was used to divide the pavement network at HCD into management units—branches, sections, and sample units. A branch is a single entity that serves a distinct function. For example, a runway is considered a branch because it serves a single function (allowing aircraft to take off and land). On an airfield, a branch typically represents an entire runway, taxiway, or apron.

Because of the disparity of characteristics that can occur throughout a branch, it is further subdivided into units called sections. A section is a portion of the pavement that has uniform construction history, pavement structure, traffic patterns, and condition throughout its entire length or area. Sections are used as a management unit for the selection of potential maintenance and rehabilitation projects. The guideline used in deciding where section breaks are located is to think of the section as the "repair unit"—a portion of the pavement that will be managed independently and evaluated separately for pavement maintenance and rehabilitation.

Pavement sections are further subdivided into sample units for inspection purposes. The typical sample unit size for asphalt concrete (AC) pavements is 5,000 square feet \pm 2,000 square feet and 20 slabs \pm 8 slabs for portland cement concrete (PCC) pavements. A statistical based sampling rate was used to determine the number of sample units to inspect for each section. The inspected sample units were representative of the overall condition within a section and were used to extrapolate the condition as a whole.

Naming Scheme

For the pavement management system to work efficiently, some unique identifiers were added to the database. The branch names assigned were designed to assist in identification of the pavement area. The first characters are used to identify the pavement use—apron, runway, taxiway, or taxilane (pavement in and around hangar areas). The next character is a number or letter used to further identify the pavement branch (such as RY1533 for Runway 15/33 or CTB for connector Taxiway B). The sections for each branch are assigned a number starting with 001, 002, and so on. Table 1 presents the branches defined for HCD and their area. For those airports with taxiway guidance signs, the branch ID may or may not match up with the signage in the field; however, the branch name will correspond.

Table 1. Branch definition.

Branch Id	Name	Number of Sections	Area (SF)
APB	APRON B (NORTH APRON)	2	127,875
CTB	CONNECTING TAXIWAY A	1	10,950
CTC	CONNECTING TAXIWAY C	1	10,950
CTCX	TAXIWAY C EXTENSION	1	16,200
CTD	CONNECTING TAXIWAY D	1	10,950
PTA	PARALLEL TAXIWAY A	3	179,990
RY1533	RUNWAY 15-33	1	300,000
TLA	TAXILANE A	5	126,100
TLB	TAXILANE B	1	51,100
Airport Total			834,115

Figure 2 presents the network definition for HCD and represents the pavements included in the APMS. Some privately built/maintained pavements and “driveways” leading into hangars may not be included here because they are considered outside the scope of work.

Pavement Evaluation

The pavement surfaces at HCD were visually inspected on July 31, 2010, using the PCI procedure. During a PCI inspection, inspectors walk over the surface of the pavement and identify visible signs of distress within a sample unit. Appendix A presents the scalable map used during the inspection to locate the inspected sample units. Each distress type is identified, then classified as low, medium, or high severity, and recorded on field sheets. In general, the higher the severity, the higher the foreign object damage (FOD) potential. The quantity, or extent, is measured for each distress/severity combination.

After collecting and summarizing the distress type, severity, and quantity for each of the inspected sample units, the distress data were entered into the MicroPAVER database and a PCI was calculated. The PCI procedure uses established deduct curves to determine the actual number of points to deduct for each distress type/severity combination, depending on the density of the distress. The inspected sample unit PCI’s were then averaged to determine an overall PCI for that section.

The PCI value provides a general sense as to the level of rehabilitation that will be needed to repair a given pavement. In general terms, maintenance activities such as crack sealing and patching often provide benefit when the PCI > 60. However, as the pavement continues to deteriorate, more complex and expensive treatments will be necessary. Pavements with a PCI between 40 and 60 are good candidates for a variety of major repairs ranging from overlays to reconstruction. Once the PCI drops below 40, reconstruction is typically the only viable alternative. Figure 3 presents the PCI inputs, rating scale, and the corresponding general work repair levels.

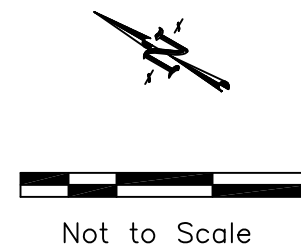
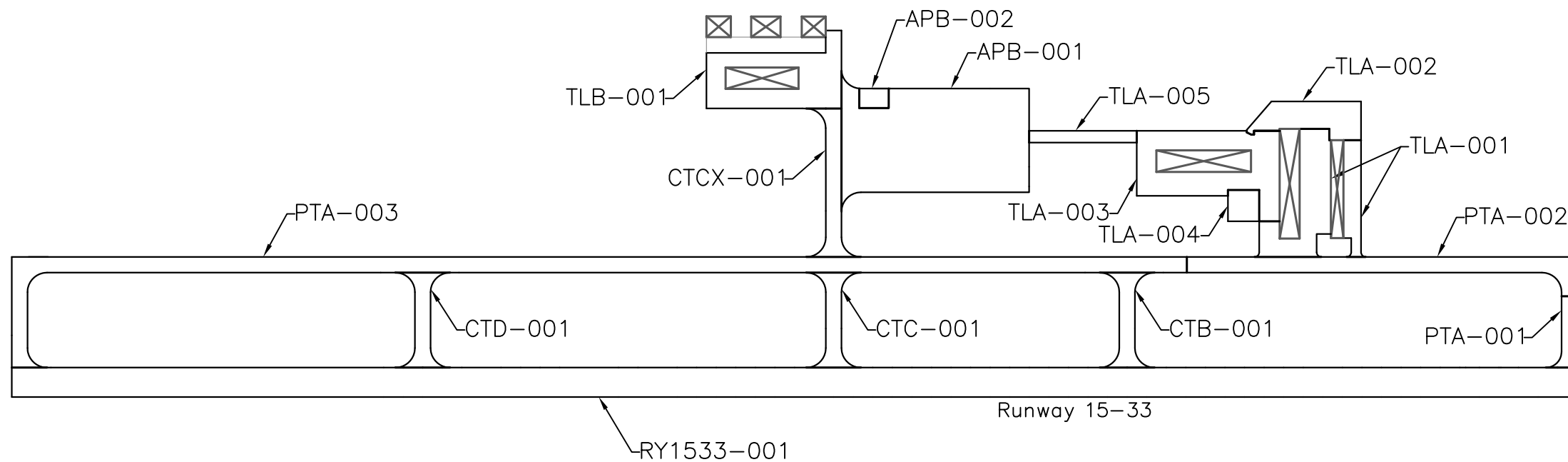

 APPLIED RESEARCH ASSOCIATES, INC.			
Network Definition Hutchinson Municipal Airport (HCD)			
ENGINEER: WRW	DRAWN BY: KLC	DATE: JUL 2010	CTAF 122.8

Figure 2. Network Definition at Hutchinson Municipal Airport (HCD).

Pavement Condition Index (PCI)

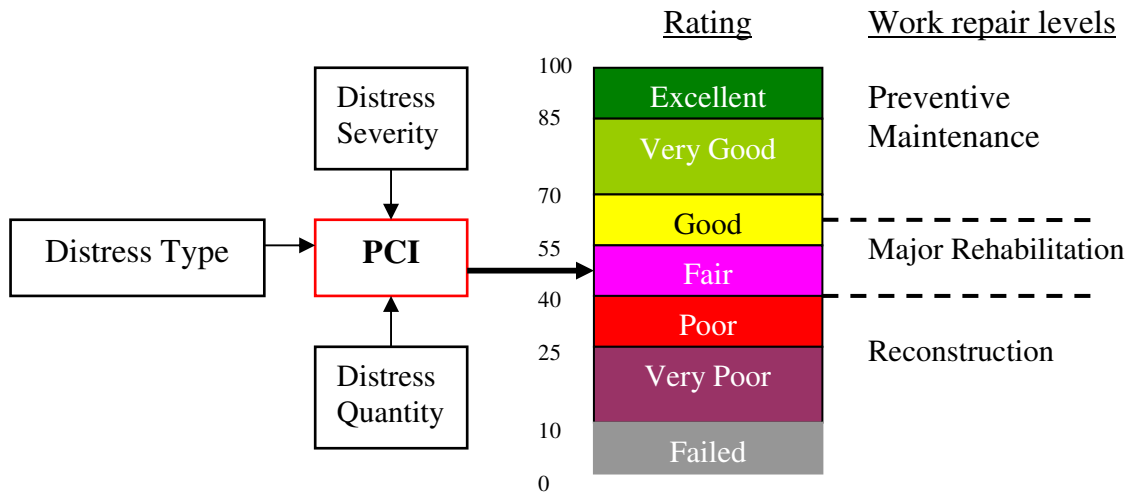

Figure 3. PCI rating scale and repair levels.

Distress Types

To better understand the cause of pavement deterioration, it is necessary to look at the distress types associated with each PCI. Each distress type has been classified into three groups based on cause—load, climate/durability, or other. Load-related distresses such as alligator cracking in asphalt pavements, or corner breaks in PCC pavements, indicate that the structural integrity of the pavement has been compromised. Climate-related distresses indicate that the pavement has aged due to seasonal environmental effects. Distresses that cannot be attributed solely to either load or climate, are classified as other. Table 2 presents the asphalt and PCC distress types in the PCI procedure, their classification, and identifies which distresses were located at HCD during the pavement inspection.

Table 2. PCI distress types.

Asphalt Distresses	Cause Classification	PCC Distresses	Cause Classification
Alligator cracking	Load	Blowup	Climate
Bleeding	Other	Corner break	Load
Block cracking	Climate	Linear cracking	Load
Corrugation	Other	Durability cracking	Climate
Depression	Other	Joint seal damage	Climate
Jet blast	Other	Small patch	Other
Joint reflection cracking	Climate	Large patch	Other
Longitudinal/transverse cracking	Climate	Popouts	Other
Oil spillage	Other	Pumping	Other
Patching	Other	Scaling/crazing	Other
Polished aggregate	Other	Faulting	Other
Weathering/raveling	Climate	Shattered slab	Load
Rutting	Load	Shrinkage cracking	Other
Shoving	Other	Joint spalling	Other
Slippage cracking	Other	Corner spalling	Other
Swelling	Other		

Indicates distresses found at HCD

PCI Results

The results of the 2010 PCI inspection are presented in figure 4. The overall area-weighted PCI for HCD is 64. When summarizing PCI values, an area-weighted calculation is used instead of a straight mathematical average because the area-weighted calculations eliminate the skewing of the PCI due to the disparity of the section sizes.

Figures 5 and 6 present the overall PCI for HCD by area distribution and pavement use, respectively. Table 3 presents the PCI summary for each section at HCD. Appendix C contains the detailed inspection report with sample unit data produced from MicroPAVER. Appendix D describes the distress types most commonly identified during the PCI inspections of Minnesota airports.

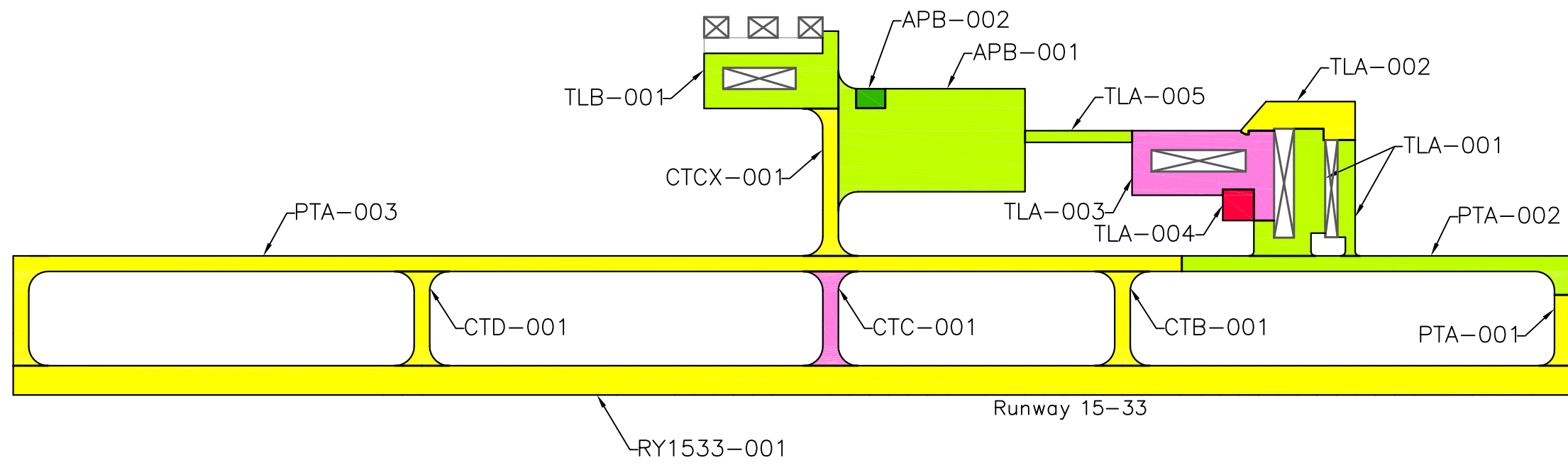

Not to Scale

	FAILED	VERY POOR	POOR	FAIR	GOOD	VERY GOOD	EXCELLENT	PCI INDEX
NS	0-10	11-25	26-40	41-55	56-70	71-85	86-100	

APPLIED RESEARCH ASSOCIATES, INC.
 2010 PCI Summary
 Hutchinson Municipal Airport (HCD)

ENGINEER: WRW	DRAWN BY: KLC	DATE: JUL 2010	CTAF 122.8
------------------	------------------	-------------------	---------------

Figure 4. 2010 Pavement Condition Index Rating at Hutchinson Municipal Airport (HCD).

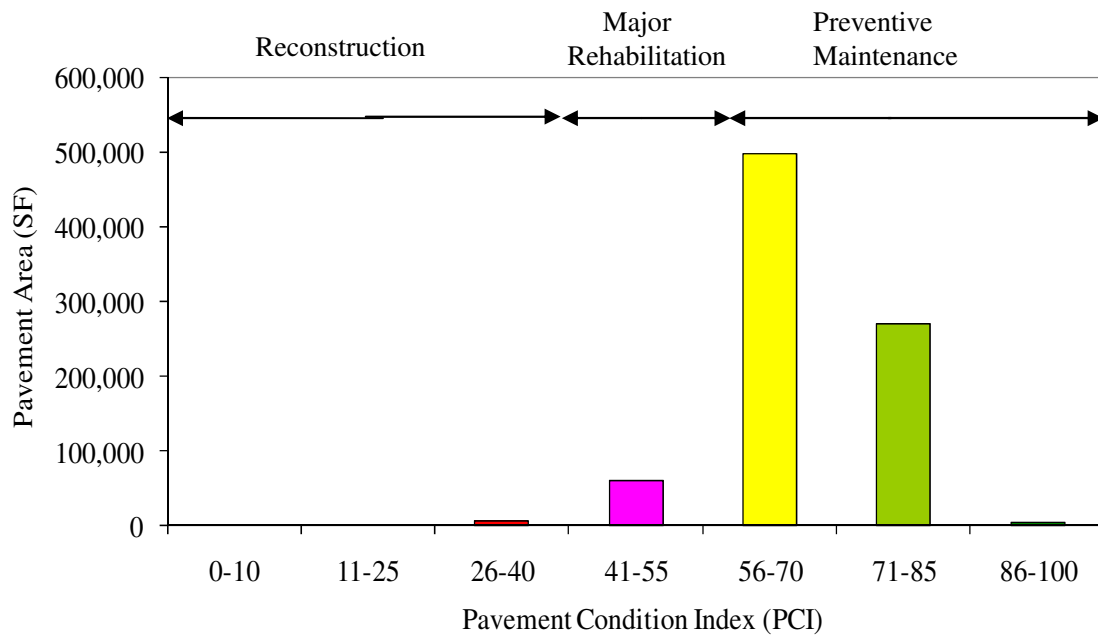

Figure 5. Condition distribution.

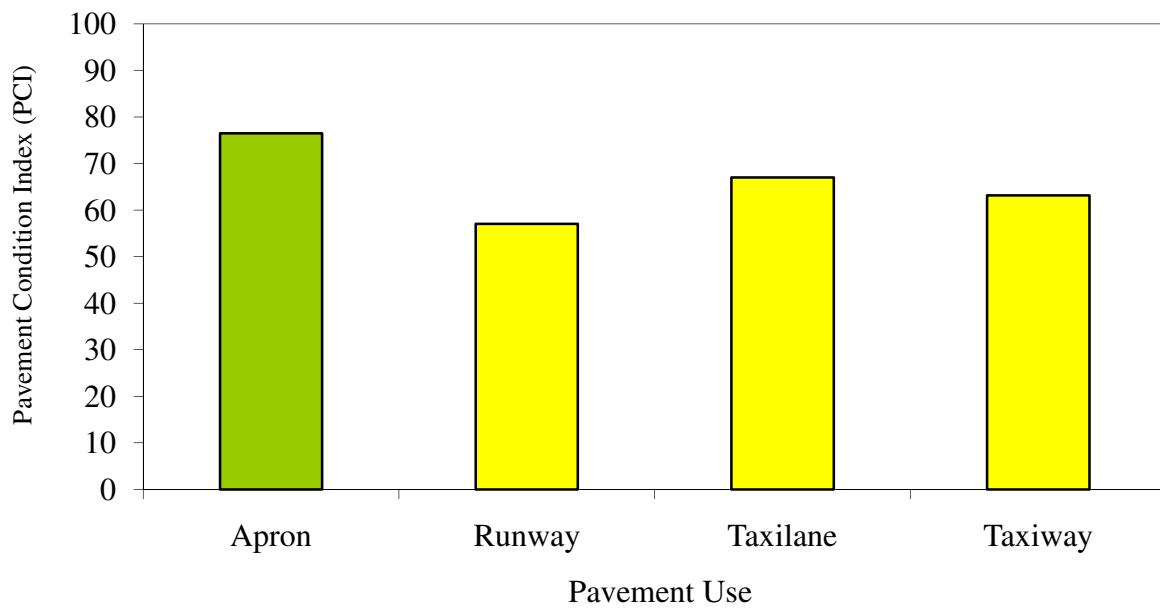

Figure 6. Area-weighted PCI by pavement use.

Table 3. PCI section summary table

Branch ID	Section ID	Surface type ¹	Section Area (SF)	LCD ²	2010 PCI	% Deduct due to		Distress types
						Load ³	Climate ⁴	
APB	1	AC	123,875	2000	76	42	58	Alligator cracking, Longitudinal & transverse (L&T) cracking, Rutting
APB	2	PCC	4,000	2000	91	0	79	Joint seal damage, Corner spall
CTB	1	AC	10,950	1994	64	22	78	Alligator cracking, L&T cracking, Weathering/raveling
CTC	1	AC	10,950	1994	55	13	87	Alligator cracking, L&T cracking, Weathering/raveling
CTCX	1	AC	16,200	2000	61	19	81	L&T cracking, Rutting
CTD	1	AC	10,950	1994	70	0	100	L&T cracking
PTA	1	AC	7,615	1994	63	25	75	Alligator cracking, L&T cracking
PTA	2	AC	42,100	2000	80	0	100	L&T cracking
PTA	3	AC	130,275	1994	58	22	75	Alligator cracking, L&T cracking, Swelling
RY1533	1	AC	300,000	1994	57	31	69	Alligator cracking, L&T cracking, Weathering/raveling, Rutting
TLA	1	AC	43,150	2000 ⁵	71	42	53	Alligator cracking, L&T cracking, Swelling
TLA	2	AC	20,600	2002 ⁵	67	0	100	L&T cracking, Weathering/raveling
TLA	3	AC	47,700	1990 ⁵	52	31	69	Alligator cracking, L&T cracking, Weathering/raveling
TLA	4	PCC	6,400	1990 ⁵	40	73	11	Corner break, Linear cracking, Joint seal damage, Small patch, Faulting, Shatter slab, Shrinkage crack, Joint spall, Corner spall
TLA	5	AC	8,250	2000 ⁵	79	0	100	L&T cracking
TLB	1	AC	51,100	2000	79	0	100	L&T cracking, Patching

¹AC = asphalt cement; AAC = asphalt overlaid with asphalt; PCC = portland cement concrete; APC = PCC overlaid with asphalt

²LCD = last construction date (original construction, last overlay, or reconstruction [whichever is most recent])

³Percent of deduct due to load = Percentage of PCI points subtracted from 100 for load related distresses

⁴Percent of deduct due to climate = Percentage of PCI points subtracted from 100 for climate/durability related distresses

⁵Estimated last construction date

Projected PCI

After the 2010 distress data was entered into MicroPAVER and the PCI determined, a modeling approach was used to predict future PCI levels based on historical PCI data from Mn/DOT’s airports. Pavements were grouped together in performance families based on similar construction, traffic, pavement use, and other factors affecting pavement performance. These performance models predict future PCI, not future distresses.

Figure 7 shows the projected PCI at HCD by percent area for the next 5 years assuming no major repairs (overlays, reconstruction, etc.) are performed during that period. It shows how quickly a pavement network can deteriorate when no capital improvements are made.

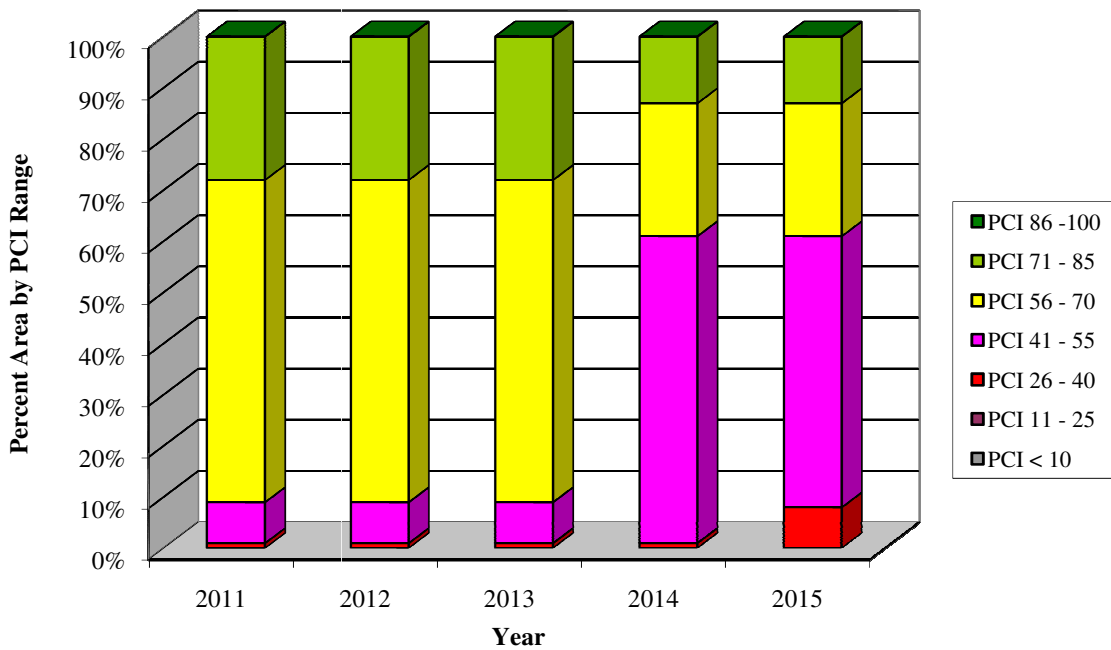

Figure 7. Projected PCI by percent area.

RECOMMENDATIONS

A 5-year maintenance and rehabilitation program was developed for HCD based on the 2010 pavement inspections and the anticipated PCI deterioration for this period. The recommendations are divided into two categories—near term maintenance and major rehabilitation. The near term maintenance is intended to address annual maintenance needs such as crack sealing and localized patching. The major rehabilitations are applied globally and are capable of returning the pavement to a nearly distress free-state. Cost for both categories are based on industry averages and may have to be adjusted to account for local costs.

The last portion of the report covers the FAA Grant Assurance Number 11 and the steps the airport must take to remain in compliance with this program.

Near Term Maintenance

Appendix F contains a maintenance work plan for HCD that identifies near term maintenance needs. The results are reported by section and by treatment type. The section format summarizes the maintenance that could be done for each pavement section by type of repair, and estimated quantity of repair. Likewise, the treatment format summarizes the quantity for each repair type across the entire airport.

When using this plan, it is recommended that the entire section be viewed to determine whether the identified distress types are so advanced in density and severity that maintenance efforts will no longer be cost-effective. Maintenance treatments are most cost-effective when applied to pavements that are generally in good condition. It is also important to understand that the maintenance plan is based on the distress types, severities, and quantities found during the 2010 PCI survey. As field conditions change, the maintenance plan will become less accurate. Therefore, it will be most useful if implemented by the end of 2011. Applying maintenance treatments should be an annual event at the airport, and this maintenance plan can serve as a baseline for that work. Guidelines for performing crack sealing and patching techniques are provided in appendix G.

Major Rehabilitation

In addition to the annual maintenance activities such as crack sealing and patching, some pavements may require more substantial rehabilitation. As a planning aid to the airport, Mn/DOT, and FAA, table 4 provides a summary from MicroPAVER of the predicted 5-year pavement rehabilitation needs at HCD. Although the predicted rehabilitation timeline identifies specific sections and the general timing for the repair, more in-depth project-level studies will be needed to determine exactly how to fix each pavement. Routine maintenance should also be programmed annually throughout the airport, but these efforts should be coordinated with the following rehabilitation recommendations.

The pavement sections identified for major rehabilitation in this report are predicted to reach a condition level where either overlays or reconstruction should be considered. Note that this analysis is based on an unlimited budget, and these recommendations will need to be adjusted to account for economic and operational constraints. Additionally,

identifying projects for work does not guarantee that Federal or State funding will be available to complete the work in the year shown. The airport and Mn/DOT should view these recommendations as viable projects when preparing future Capital Improvement Plans (CIP).

Table 4. Recommended 5-year major rehabilitation plan.

Branch ID	Section ID	Year	Estimated Cost
CTC	1	2011	\$44,588
PTA	3	2011	\$470,489
RY1533	1	2011	\$1,122,601
TLA	3	2011	\$220,565
TLA	4	2011	\$37,384
CTCX	1	2012	\$53,525
PTA	1	2014	\$25,080
CTB	1	2015	\$36,064
5-year Airport Total			\$2,010,296

Federal Guidelines

In 1995, Congress mandated that the FAA require, as a condition of grant funding, that airports be prepared to present documentation of a maintenance management program on pavement that has been constructed, reconstructed, or repaired with Federal assistance.

The FAA has defined an acceptable maintenance management program, and this report fulfills many requirements of such a program, including documenting:

- Locations of all runways, taxiways, and aprons.
- Dimensions of the pavement system.
- Types of pavement.
- Year of construction or most recent major rehabilitation.

However, **the airport owner must be an active participant**, specifically by implementing the following actions:

- Annotate pavement areas that have been constructed, reconstructed, or repaired with Federal financial assistance.
- Conduct a "drive-by" inspection at least monthly to detect changes in pavement condition.
- Keep complete records of maintenance activities. Record the date of each "drive-by" inspection and any maintenance performed as a result. Records must be maintained on file for a minimum of 5 years.
- Document detailed inspection information with a history of recorded pavement deterioration by PCI survey (e.g., this report).

An example of a form that can be completed during “drive-by” inspections is provided in appendix G.

This page intentionally blank.

Appendix A

Sample Unit Maps

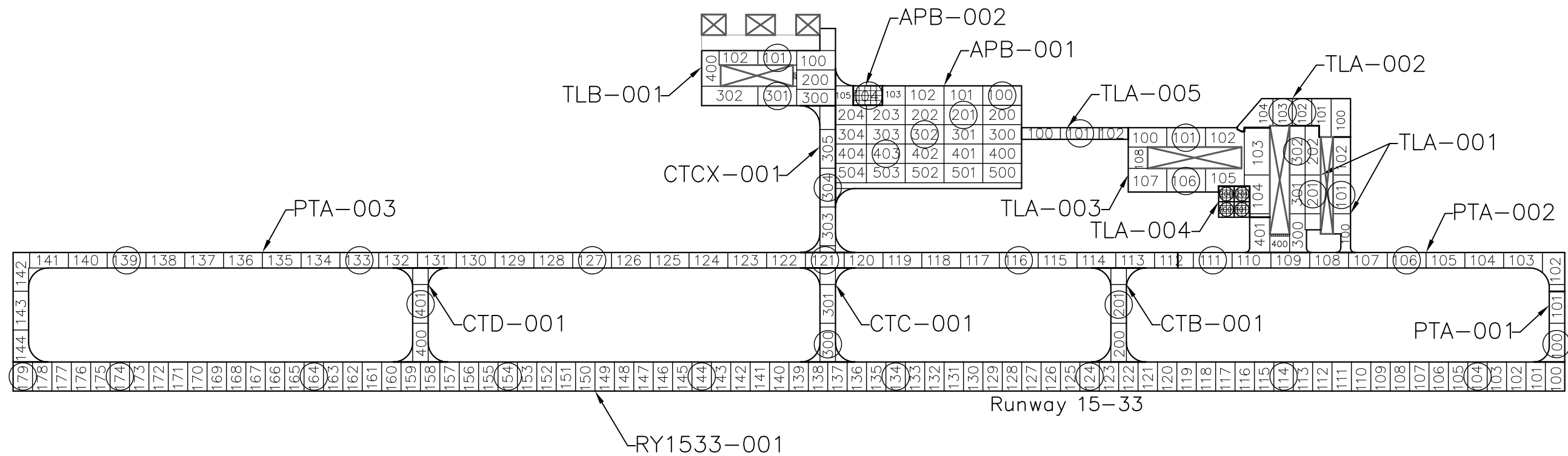

○ Denotes sample unit surveyed

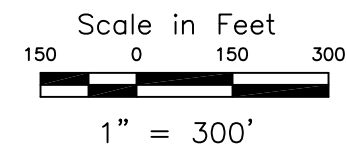

Sample Unit Layout Hutchinson Municipal Airport (HCD)			
ENGINEER: WRW	DRAWN BY: KLC	DATE: JUL 2010	CTAF 122.8

Figure A.1. Sample unit layout for runway and taxiways at Hutchinson Municipal Airport (HCD).

Appendix B

Pictures



HCD APB 001 (PCI = 76)



HCD APB 002 (PCI = 91)



HCD CTB 001 (PCI = 64)



HCD CTC 001 (PCI = 55)



HCD CTCX 001 (PCI = 61)



HCD CTD 001 (PCI = 70)



HCD PTA 001 (PCI = 63)



HCD PTA 002 (PCI = 80)



HCD PTA 003 (PCI = 58)



HCD RY1533 001 (PCI = 57)



HCD TLA 001 (PCI = 71)



HCD TLA 002 (PCI = 67)



HCD TLA 003 (PCI = 52)



HCD TLA 004 (PCI = 40)



HCD TLA 005 (PCI = 79)



HCD TLB 001 (PCI = 79)

This page intentionally left blank.

Appendix C

PCI Distress Report

Re-inspection Report

MN102-2010

Report Generated Date: 10/5/2010

Site Name:

Network: HCD Name: HUTCHINSON

Branch: APB Name: APRON B (NORTH APRON) Use: APRON Area: 127,875.00SqFt

Section: 001 of 2 From: 100 To: 504 Last Const.: 9/30/2000

Surface: AC Family: Zone: S Category: 3 Rank: S

Area: 123,875.00SqFt Length: 480.00Ft Width: 265.00Ft

Shoulder: Street Type: Grade: 0.00 Lanes: 0

Section Comments:

Last Insp. Date: 7/31/2010 Total Samples: 25 Surveyed: 4

Conditions: PCI:76.00 |

Sample Number: 100 Type: R Area: 5,000.00SqFt PCI = 86

48 LONGITUDINAL/TRANSVERSE CRACKING L 101.00 Ft

48 LONGITUDINAL/TRANSVERSE CRACKING M 28.00 Ft

Sample Number: 201 Type: R Area: 5,000.00SqFt PCI = 82

48 LONGITUDINAL/TRANSVERSE CRACKING L 137.00 Ft

48 LONGITUDINAL/TRANSVERSE CRACKING M 70.00 Ft

Sample Number: 302 Type: R Area: 5,000.00SqFt PCI = 73

48 LONGITUDINAL/TRANSVERSE CRACKING L 256.00 Ft

48 LONGITUDINAL/TRANSVERSE CRACKING M 110.00 Ft

53 RUTTING L 2.00 SqFt

Sample Number: 403 Type: R Area: 5,000.00SqFt PCI = 64

41 ALLIGATOR CRACKING L 55.00 SqFt

48 LONGITUDINAL/TRANSVERSE CRACKING L 287.00 Ft

48 LONGITUDINAL/TRANSVERSE CRACKING M 80.00 Ft

53 RUTTING L 4.00 SqFt

Re-inspection Report

MN102-2010

Report Generated Date: 10/5/2010

Site Name:

Network: HCD Name: HUTCHINSON

Branch: APB Name: APRON B (NORTH APRON) Use: APRON Area: 127,875.00SqFt

Section: 002 of 2 From: 104 To: 104 Last Const.: 9/30/2000

Surface: PCC Family: MN2010 PCC Zone: S Category: 3 Rank: S

Area: 4,000.00SqFt Length: 80.00Ft Width: 50.00Ft

Shoulder: Street Type: Grade: 0.00 Lanes: 0

Section Comments:

Last Insp. Date: 7/31/2010 Total Samples: 1 Surveyed: 1

Conditions: PCI:91.00 |

Sample Number: 104 Type: R Area: 20.00Slabs PCI = 91

75 CORNER SPALLING L 1.00 Slabs

65 JOINT SEAL DAMAGE M 20.00 Slabs

Re-inspection Report

MN102-2010

Report Generated Date: 10/5/2010

Site Name:

Network: HCD Name: HUTCHINSON

Branch: CTB Name: CONNECTING TAXIWAY A Use: TAXIWAY Area: 10,950.00SqFt

Section: 001 of 1 From: 200 To: 201 Last Const.: 9/30/1994

Surface: AC Family: MN2010 Asphalt TW Zone: S Category: 3 Rank: S

Area: 10,950.00SqFt Length: 240.00Ft Width: 40.00Ft

Shoulder: Street Type: Grade: 0.00 Lanes: 0

Section Comments:

Last Insp. Date: 7/31/2010 Total Samples: 3 Surveyed: 1

Conditions: PCI:64.00 |

Sample Number: 201 Type: R Area: 4,000.00SqFt PCI = 64

48	LONGITUDINAL/TRANSVERSE CRACKING	L	92.00	Ft
48	LONGITUDINAL/TRANSVERSE CRACKING	M	111.00	Ft
48	LONGITUDINAL/TRANSVERSE CRACKING	H	20.00	Ft
52	WEATHERING/RAVELING	L	40.00	SqFt
41	ALLIGATOR CRACKING	L	15.00	SqFt

Re-inspection Report

MN102-2010

Report Generated Date: 10/5/2010

Site Name:

Network: HCD Name: HUTCHINSON

Branch: CTC Name: CONNECTING TAXIWAY C Use: TAXIWAY Area: 10,950.00SqFt

Section: 001 of 1 From: 300 To: 301 Last Const.: 9/30/1994

Surface: AC Family: MN2010 Asphalt TW Zone: S Category: 3 Rank: P

Area: 10,950.00SqFt Length: 240.00Ft Width: 40.00Ft

Shoulder: Street Type: Grade: 0.00 Lanes: 0

Section Comments:

Last Insp. Date: 7/31/2010 Total Samples: 3 Surveyed: 1

Conditions: PCI:55.00 |

Sample Number: 300 Type: R Area: 4,000.00SqFt PCI = 55

48	LONGITUDINAL/TRANSVERSE CRACKING	L	126.00	Ft
48	LONGITUDINAL/TRANSVERSE CRACKING	M	26.00	Ft
48	LONGITUDINAL/TRANSVERSE CRACKING	H	80.00	Ft
41	ALLIGATOR CRACKING	L	5.00	SqFt
52	WEATHERING/RAVELING	L	40.00	SqFt

Re-inspection Report

MN102-2010

Report Generated Date: 10/5/2010

Site Name:

Network: HCD Name: HUTCHINSON

Branch: CTCX Name: TAXIWAY C EXTENSION Use: TAXIWAY Area: 16,200.00SqFt

Section: 001 of 1 From: 302+82 To: 306+80 Last Const.: 9/30/2000

Surface: AC Family: MN2010 Asphalt TW Zone: S Category: 3 Rank: P

Area: 16,200.00SqFt Length: 380.00Ft Width: 40.00Ft

Shoulder: Street Type: Grade: 0.00 Lanes: 0

Section Comments:

Last Insp. Date: 7/31/2010 Total Samples: 4 Surveyed: 1

Conditions: PCI:61.00 I

Sample Number: 304 Type: R Area: 4,000.00SqFt PCI = 61

48	LONGITUDINAL/TRANSVERSE CRACKING	L	294.00	Ft
48	LONGITUDINAL/TRANSVERSE CRACKING	M	20.00	Ft
48	LONGITUDINAL/TRANSVERSE CRACKING	H	60.00	Ft
53	RUTTING	L	15.00	SqFt

Re-inspection Report

MN102-2010

Report Generated Date: 10/5/2010

Site Name:

Network: HCD Name: HUTCHINSON

Branch: CTD Name: CONNECTING TAXIWAY D Use: TAXIWAY Area: 10,950.00SqFt

Section: 001 of 1 From: 400 To: 401 Last Const.: 9/30/1994

Surface: AC Family: MN2010 Asphalt TW Zone: S Category: 3 Rank: S

Area: 10,950.00SqFt Length: 240.00Ft Width: 40.00Ft

Shoulder: Street Type: Grade: 0.00 Lanes: 0

Section Comments:

Last Insp. Date: 7/31/2010 Total Samples: 3 Surveyed: 1

Conditions: PCI:70.00 |

Sample Number: 401 Type: R Area: 4,000.00SqFt PCI = 70

48 LONGITUDINAL/TRANSVERSE CRACKING L 63.00 Ft

48 LONGITUDINAL/TRANSVERSE CRACKING M 99.00 Ft

48 LONGITUDINAL/TRANSVERSE CRACKING H 40.00 Ft

Re-inspection Report

MN102-2010

Report Generated Date: 10/5/2010

Site Name:

Network: HCD Name: HUTCHINSON

Branch: PTA Name: PARALLEL TAXIWAY A Use: TAXIWAY Area: 179,990.00SqFt

Section: 001 of 3 From: 100 To: 101+82 Last Const.: 9/30/1994

Surface: AC Family: MN2010 Asphalt TW Zone: S Category: 3 Rank: P

Area: 7,615.00SqFt Length: 182.00Ft Width: 40.00Ft

Shoulder: Street Type: Grade: 0.00 Lanes: 0

Section Comments:

Last Insp. Date: 7/31/2010 Total Samples: 2 Surveyed: 1

Conditions: PCI:63.00 I

Sample Number: 100 Type: R Area: 4,335.00SqFt PCI = 63

48	LONGITUDINAL/TRANSVERSE CRACKING	L	94.00	Ft
48	LONGITUDINAL/TRANSVERSE CRACKING	M	156.00	Ft
48	LONGITUDINAL/TRANSVERSE CRACKING	H	4.00	Ft
41	ALLIGATOR CRACKING	L	16.00	SqFt

Re-inspection Report

MN102-2010

Report Generated Date: 10/5/2010

Site Name:

Network: HCD Name: HUTCHINSON

Branch: PTA Name: PARALLEL TAXIWAY A Use: TAXIWAY Area: 179,990.00SqFt

Section: 002 of 3 From: 101+82 To: 112+40 Last Const.: 9/30/2000

Surface: AC Family: MN2010 Asphalt TW Zone: S Category: 3 Rank: P

Area: 42,100.00SqFt Length: 1,040.00Ft Width: 40.00Ft

Shoulder: Street Type: Grade: 0.00 Lanes: 0

Section Comments:

Last Insp. Date: 7/31/2010 Total Samples: 10 Surveyed: 2

Conditions: PCI:80.00 I

Sample Number: 106 Type: R Area: 4,000.00SqFt PCI = 79

48 LONGITUDINAL/TRANSVERSE CRACKING L 105.00 Ft

48 LONGITUDINAL/TRANSVERSE CRACKING M 80.00 Ft

Sample Number: 111 Type: R Area: 4,000.00SqFt PCI = 80

48 LONGITUDINAL/TRANSVERSE CRACKING L 198.00 Ft

48 LONGITUDINAL/TRANSVERSE CRACKING M 55.00 Ft

Re-inspection Report

MN102-2010

Report Generated Date: 10/5/2010

Site Name:

Network: HCD Name: HUTCHINSON

Branch: PTA Name: PARALLEL TAXIWAY A Use: TAXIWAY Area: 179,990.00SqFt

Section: 003 of 3 From: 112+40 To: 144 Last Const.: 9/30/1994

Surface: AC Family: MN2010 Asphalt TW Zone: S Category: 3 Rank: P

Area: 130,275.00SqFt Length: 3,240.00Ft Width: 40.00Ft

Shoulder: Street Type: Grade: 0.00 Lanes: 0

Section Comments:

Last Insp. Date: 7/31/2010 Total Samples: 33 Surveyed: 5

Conditions: PCI:58.00 |

Sample Number: 116 Type: R Area: 4,000.00SqFt PCI = 63

48 LONGITUDINAL/TRANSVERSE CRACKING L 173.00 Ft

48 LONGITUDINAL/TRANSVERSE CRACKING M 22.00 Ft

48 LONGITUDINAL/TRANSVERSE CRACKING H 80.00 Ft

Sample Number: 121 Type: R Area: 4,000.00SqFt PCI = 56

48 LONGITUDINAL/TRANSVERSE CRACKING L 298.00 Ft

48 LONGITUDINAL/TRANSVERSE CRACKING M 96.00 Ft

48 LONGITUDINAL/TRANSVERSE CRACKING H 130.00 Ft

Sample Number: 127 Type: R Area: 4,000.00SqFt PCI = 47

48 LONGITUDINAL/TRANSVERSE CRACKING L 206.00 Ft

48 LONGITUDINAL/TRANSVERSE CRACKING M 62.00 Ft

48 LONGITUDINAL/TRANSVERSE CRACKING H 80.00 Ft

41 ALLIGATOR CRACKING L 130.00 SqFt

56 SWELLING L 130.00 SqFt

Sample Number: 133 Type: R Area: 4,000.00SqFt PCI = 57

48 LONGITUDINAL/TRANSVERSE CRACKING L 164.00 Ft

48 LONGITUDINAL/TRANSVERSE CRACKING M 51.00 Ft

48 LONGITUDINAL/TRANSVERSE CRACKING H 120.00 Ft

Sample Number: 139 Type: R Area: 4,000.00SqFt PCI = 68

48 LONGITUDINAL/TRANSVERSE CRACKING L 270.00 Ft

48 LONGITUDINAL/TRANSVERSE CRACKING H 80.00 Ft

Re-inspection Report

MN102-2010

Report Generated Date: 10/5/2010

Site Name:

Network: HCD Name: HUTCHINSON

Branch: RY1533 Name: RUNWAY 15-33 Use: RUNWAY Area: 300,000.01SqFt

Section: 001 of 1 From: 100 To: 179 Last Const.: 9/30/1994

Surface: AC Family: MN2010 Asphalt RW Zone: S Category: 3 Rank: P

Area: 300,000.01SqFt Length: 4,000.00Ft Width: 75.00Ft

Shoulder: Street Type: Grade: 0.00 Lanes: 0

Section Comments:

Last Insp. Date: 7/31/2010 Total Samples: 80 Surveyed: 9

Conditions: PCI:57.00 |

Sample Number: 104 Type: R Area: 3,750.00SqFt PCI = 54

48 LONGITUDINAL/TRANSVERSE CRACKING L 247.00 Ft

48 LONGITUDINAL/TRANSVERSE CRACKING M 2.00 Ft

48 LONGITUDINAL/TRANSVERSE CRACKING H 150.00 Ft

Sample Number: 114 Type: R Area: 3,750.00SqFt PCI = 68

48 LONGITUDINAL/TRANSVERSE CRACKING L 210.00 Ft

48 LONGITUDINAL/TRANSVERSE CRACKING H 75.00 Ft

Sample Number: 124 Type: R Area: 3,750.00SqFt PCI = 53

48 LONGITUDINAL/TRANSVERSE CRACKING L 267.00 Ft

48 LONGITUDINAL/TRANSVERSE CRACKING M 16.00 Ft

48 LONGITUDINAL/TRANSVERSE CRACKING H 150.00 Ft

Sample Number: 134 Type: R Area: 3,750.00SqFt PCI = 58

48 LONGITUDINAL/TRANSVERSE CRACKING L 194.00 Ft

48 LONGITUDINAL/TRANSVERSE CRACKING M 37.00 Ft

48 LONGITUDINAL/TRANSVERSE CRACKING H 75.00 Ft

41 ALLIGATOR CRACKING L 1.00 SqFt

Sample Number: 144 Type: R Area: 3,750.00SqFt PCI = 53

48 LONGITUDINAL/TRANSVERSE CRACKING L 203.00 Ft

48 LONGITUDINAL/TRANSVERSE CRACKING H 150.00 Ft

41 ALLIGATOR CRACKING L 1.00 SqFt

Sample Number: 154 Type: R Area: 3,750.00SqFt PCI = 63

48 LONGITUDINAL/TRANSVERSE CRACKING L 233.00 Ft

48 LONGITUDINAL/TRANSVERSE CRACKING M 7.00 Ft

48 LONGITUDINAL/TRANSVERSE CRACKING H 75.00 Ft

Sample Number: 164 Type: R Area: 3,750.00SqFt PCI = 51

48 LONGITUDINAL/TRANSVERSE CRACKING L 175.00 Ft

48 LONGITUDINAL/TRANSVERSE CRACKING M 3.00 Ft

48 LONGITUDINAL/TRANSVERSE CRACKING H 150.00 Ft

52 WEATHERING/RAVELING L 30.00 SqFt

Sample Number: 174 Type: R Area: 3,750.00SqFt PCI = 63

48 LONGITUDINAL/TRANSVERSE CRACKING L 267.00 Ft

48 LONGITUDINAL/TRANSVERSE CRACKING M 28.00 Ft

48 LONGITUDINAL/TRANSVERSE CRACKING H 75.00 Ft

Sample Number: 179 Type: A Area: 3,750.00SqFt PCI = 36

48 LONGITUDINAL/TRANSVERSE CRACKING L 224.00 Ft

48 LONGITUDINAL/TRANSVERSE CRACKING M 51.00 Ft

Re-inspection Report

MN102-2010

Report Generated Date: 10/5/2010

Site Name:

48	LONGITUDINAL/TRANSVERSE CRACKING	H	75.00	Ft
41	ALLIGATOR CRACKING	L	20.00	SqFt
41	ALLIGATOR CRACKING	M	86.00	SqFt
53	RUTTING	L	75.00	SqFt

Re-inspection Report

MN102-2010

Report Generated Date: 10/5/2010

Site Name:

Network: HCD Name: HUTCHINSON

Branch: TLA Name: Taxilane A Use: TAXILANE Area: 126,100.00SqFt

Section: 001 of 5 From: 100 To: 401 Last Const.: 6/1/2000
Surface: AC Family: MN2010 Asphalt TL Zone: S Category: 3 Rank: T
Area: 43,150.00SqFt Length: 625.00Ft Width: 50.00Ft
Shoulder: Street Type: Grade: 0.00 Lanes: 0
Section Comments: Estimated LCD

Last Insp. Date: 7/31/2010 Total Samples: 11 Surveyed: 3
Conditions: PCI: 71.00 |

Sample Number: 101 Type: R Area: 4,500.00SqFt PCI = 84
48 LONGITUDINAL/TRANSVERSE CRACKING L 128.00 Ft
48 LONGITUDINAL/TRANSVERSE CRACKING M 46.00 Ft

Sample Number: 201 Type: R Area: 4,000.00SqFt PCI = 51
41 ALLIGATOR CRACKING M 65.00 SqFt
56 SWELLING L 130.00 SqFt
48 LONGITUDINAL/TRANSVERSE CRACKING L 174.00 Ft
48 LONGITUDINAL/TRANSVERSE CRACKING M 48.00 Ft

Sample Number: 302 Type: R Area: 5,200.00SqFt PCI = 77
48 LONGITUDINAL/TRANSVERSE CRACKING L 354.00 Ft
48 LONGITUDINAL/TRANSVERSE CRACKING M 117.00 Ft

Re-inspection Report

MN102-2010

Report Generated Date: 10/5/2010

Site Name:

Network: HCD Name: HUTCHINSON

Branch: TLA Name: Taxilane A Use: TAXILANE Area: 126,100.00SqFt

Section: 002 of 5 From: 100 To: 104 Last Const.: 6/1/2002

Surface: AC Family: MN2010 Asphalt TL Zone: S Category: 3 Rank: T

Area: 20,600.00SqFt Length: 260.00Ft Width: 70.00Ft

Shoulder: Street Type: Grade: 0.00 Lanes: 0

Section Comments: Estimated LCD

Last Insp. Date: 7/31/2010 Total Samples: 5 Surveyed: 2

Conditions: PCI:67.00 |

Sample Number: 102 Type: R Area: 3,500.00SqFt PCI = 65

48 LONGITUDINAL/TRANSVERSE CRACKING L 9.00 Ft

48 LONGITUDINAL/TRANSVERSE CRACKING M 48.00 Ft

52 WEATHERING/RAVELING L 3,500.00 SqFt

Sample Number: 103 Type: R Area: 3,500.00SqFt PCI = 69

48 LONGITUDINAL/TRANSVERSE CRACKING L 28.00 Ft

52 WEATHERING/RAVELING L 3,500.00 SqFt

Re-inspection Report

MN102-2010

Report Generated Date: 10/5/2010

Site Name:

Network: HCD Name: HUTCHINSON

Branch: TLA Name: Taxilane A Use: TAXILANE Area: 126,100.00SqFt

Section: 003 of 5 From: 100 To: 107 Last Const.: 6/1/1990

Surface: AC Family: MN2010 Asphalt TL Zone: S Category: 3 Rank: T

Area: 47,700.00SqFt Length: 360.00Ft Width: 165.00Ft

Shoulder: Street Type: Grade: 0.00 Lanes: 0

Section Comments: Estimated LCD

Last Insp. Date: 7/31/2010 Total Samples: 8 Surveyed: 2

Conditions: PCI:52.00 |

Sample Number: 101 Type: R Area: 5,000.00SqFt PCI = 52

48	LONGITUDINAL/TRANSVERSE CRACKING	L	477.00	Ft
48	LONGITUDINAL/TRANSVERSE CRACKING	M	128.00	Ft
52	WEATHERING/RAVELING	L	2,500.00	SqFt
52	WEATHERING/RAVELING	M	5.00	SqFt
52	WEATHERING/RAVELING	H	8.00	SqFt
41	ALLIGATOR CRACKING	L	44.00	SqFt

Sample Number: 106 Type: R Area: 6,200.00SqFt PCI = 52

48	LONGITUDINAL/TRANSVERSE CRACKING	L	496.00	Ft
48	LONGITUDINAL/TRANSVERSE CRACKING	M	197.00	Ft
52	WEATHERING/RAVELING	L	3,100.00	SqFt
52	WEATHERING/RAVELING	M	20.00	SqFt
41	ALLIGATOR CRACKING	M	40.00	SqFt

Re-inspection Report

MN102-2010

Report Generated Date: 10/5/2010

Site Name:

Network: HCD Name: HUTCHINSON

Branch: TLA Name: Taxilane A Use: TAXILANE Area: 126,100.00SqFt

Section: 004 of 5 From: 100 To: 201 Last Const.: 6/1/1990
Surface: PCC Family: MN2010 PCC Zone: S Category: 3 Rank: T
Area: 6,400.00SqFt Length: 80.00Ft Width: 80.00Ft
Shoulder: Street Type: Grade: 0.00 Lanes: 0
Section Comments: Estimated LCD

Last Insp. Date: 7/31/2010 Total Samples: 4 Surveyed: 4
Conditions: PCI:40.00 |

Sample Number: 100 Type: R Area: 16.00Slabs PCI = 32
62 CORNER BREAK L 1.00 Slabs
63 LINEAR CRACKING L 1.00 Slabs
71 FAULTING L 1.00 Slabs
72 SHATTERED SLAB L 1.00 Slabs
72 SHATTERED SLAB M 5.00 Slabs
73 SHRINKAGE CRACKING N 1.00 Slabs
75 CORNER SPALLING L 1.00 Slabs
65 JOINT SEAL DAMAGE H 16.00 Slabs

Sample Number: 101 Type: R Area: 16.00Slabs PCI = 51
62 CORNER BREAK L 3.00 Slabs
62 CORNER BREAK M 1.00 Slabs
62 CORNER BREAK H 1.00 Slabs
71 FAULTING L 2.00 Slabs
73 SHRINKAGE CRACKING N 1.00 Slabs
74 JOINT SPALLING M 1.00 Slabs
75 CORNER SPALLING L 1.00 Slabs
65 JOINT SEAL DAMAGE H 16.00 Slabs

Sample Number: 200 Type: R Area: 16.00Slabs PCI = 40
62 CORNER BREAK L 2.00 Slabs
62 CORNER BREAK M 1.00 Slabs
62 CORNER BREAK H 1.00 Slabs
63 LINEAR CRACKING L 1.00 Slabs
66 SMALL PATCH M 2.00 Slabs
72 SHATTERED SLAB L 1.00 Slabs
72 SHATTERED SLAB M 1.00 Slabs
73 SHRINKAGE CRACKING N 1.00 Slabs
65 JOINT SEAL DAMAGE H 16.00 Slabs

Sample Number: 201 Type: R Area: 16.00Slabs PCI = 35
62 CORNER BREAK L 1.00 Slabs
62 CORNER BREAK M 4.00 Slabs
63 LINEAR CRACKING L 2.00 Slabs
63 LINEAR CRACKING M 1.00 Slabs
71 FAULTING L 2.00 Slabs
71 FAULTING M 1.00 Slabs
72 SHATTERED SLAB M 1.00 Slabs
73 SHRINKAGE CRACKING N 1.00 Slabs
65 JOINT SEAL DAMAGE H 16.00 Slabs

Re-inspection Report

MN102-2010

Report Generated Date: 10/5/2010

Site Name:

Network: HCD Name: HUTCHINSON

Branch: TLA Name: Taxilane A Use: TAXILANE Area: 126,100.00SqFt

Section: 005 of 5 From: 100 To: 102 Last Const.: 6/1/2000

Surface: AC Family: MN2010 Asphalt TL Zone: S Category: 3 Rank: T

Area: 8,250.00SqFt Length: 275.00Ft Width: 30.00Ft

Shoulder: Street Type: Grade: 0.00 Lanes: 0

Section Comments: Estimated LCD

Last Insp. Date: 7/31/2010 Total Samples: 3 Surveyed: 1

Conditions: PCI:79.00 |

Sample Number: 101 Type: R Area: 3,000.00SqFt PCI = 79

48 LONGITUDINAL/TRANSVERSE CRACKING L 118.00 Ft

48 LONGITUDINAL/TRANSVERSE CRACKING M 61.00 Ft

Re-inspection Report

MN102-2010

Report Generated Date: 10/5/2010

Site Name:

Network: HCD Name: HUTCHINSON

Branch: TLB Name: TAXILANE B Use: TAXILANE Area: 51,100.00SqFt

Section: 001 of 1 From: 100 To: 400 Last Const.: 9/30/2000

Surface: AC Family: MN2010 Asphalt TL Zone: S Category: 3 Rank: T

Area: 51,100.00SqFt Length: 350.00Ft Width: 146.00Ft

Shoulder: Street Type: Grade: 0.00 Lanes: 0

Section Comments:

Last Insp. Date: 7/31/2010 Total Samples: 8 Surveyed: 2

Conditions: PCI:79.00 I

Sample Number: 101 Type: R Area: 3,700.00SqFt PCI = 82

48 LONGITUDINAL/TRANSVERSE CRACKING L 162.00 Ft

48 LONGITUDINAL/TRANSVERSE CRACKING M 54.00 Ft

Sample Number: 301 Type: R Area: 5,000.00SqFt PCI = 78

48 LONGITUDINAL/TRANSVERSE CRACKING L 171.00 Ft

48 LONGITUDINAL/TRANSVERSE CRACKING M 96.00 Ft

50 PATCHING L 12.00 SqFt

Appendix D

Distress Identification

DISTRESS IDENTIFICATION

This appendix lists and describes distress types most commonly identified during the PCI inspections of Minnesota airports. Note that the pictures provided in this appendix are for illustration purposes and do not necessarily reflect the conditions or pavements at this airport. Descriptions and measurement inspection criteria are provided herein.

Flexible Pavement Distress

Example of Longitudinal and Transverse Cracking



Longitudinal and transverse cracks are caused by pavement aging, by construction, and by subsurface movement. Aging occurs as pavement loses some of its components to the atmosphere and becomes more brittle. Consistent application of pavement sealcoats can help to prevent the occurrence of age related cracks. Cracks will also develop along poorly constructed paving lane joints. Ensuring that joints are made when both sides are still hot, and near the same temperature, is one of the best ways to mitigate this potential problem. Seasonal movement caused by changes in moisture content or temperature differences can also cause pavement cracks. Asphalt pavement placed over a PCC pavement or cement stabilized base course may evidence reflective cracking from the underlying material. Longitudinal and transverse cracks are not caused by wheel loads, although traffic may worsen their condition.

Low severity longitudinal and transverse cracks are less than ¼ inch wide, or if sealed with suitable filler material in satisfactory condition can be any width, less than 3 inches, if they are not spalled. Maintenance usually is not indicated for low-severity cracking. Moderately spalled cracks and cracks wider than ¼ inch which are not satisfactorily sealed are at medium severity. Medium-severity cracks should be sealed with a high-

quality crack filling material. Severely spalled cracks and cracks wider than 3 inches are at high severity. High-severity L&T cracks normally require patching.

Example of Block Cracking



Block cracking is longitudinal and transverse cracking that has established a pattern of blocks ranging in size from 1ft x 1ft to 10ft x 10ft. This distress typically happens in older asphalt pavements and is an indication that the bituminous binder has lost most of its flexibility. The severity determination is basically determined by the crack width criteria defined for longitudinal and transverse cracking. Crack sealing typically is used to repair block cracking; however, the amount of required sealant can be extensive due to the high density of cracks.

Example of Alligator Cracking



Alligator (or fatigue) cracks are a series of interconnected load-related cracks caused by fatigue of the asphalt surface. Alligator cracking is a significant structural distress and develops only in places subject to traffic loads. These cracks typically initiate at the bottom of the asphalt layer (where tensile strains are highest) and propagate upward - so once a fatigue crack is visible, significant damage has already occurred.

At low severity, alligator cracks are evidenced by a series of parallel hairline cracks (usually in a wheel path). Further traffic and deterioration leads to the interconnection of these cracks. Medium severity alligator cracking is a well-defined pattern of interconnected cracks, some spalling may be present. High severity alligator cracks have lost aggregate interlock between adjacent pieces, the cracks may be severely spalled with FOD potential, and most likely the pieces will move freely under traffic.

Alligator cracking is a structural failure and cannot be repaired with sealant, the proper repair is full-depth patching.

Example of Raveling/Weathering



Raveling and weathering are the wearing away of the pavement surface. This can be caused by the dislodging of aggregate particles or the loss of asphalt binder. This distress is usually evident over large areas. Raveling and weathering may indicate that the asphalt binder has hardened significantly. At low severity, the surface has started to wear away with few (if any) loose particles and the coarse surface aggregate is exposed to 1/4 of its diameter. At medium severity, the aggregate and/or binder have worn away with some loose and missing particles, and the surface texture is moderately rough and pitted, but the average depth of erosion is less than 1/4 inch. At high severity, the aggregate and/or binder have worn away with a large amount of loose and missing particles, the surface texture is severely rough and pitted, and the top layer of aggregate has eroded away.

Example of Patching



Patched areas are defined when a portion of the original pavement is replaced with a material intended as a semi-permanent repair. A patch is documented as a defect because it is considered a break in the integrity of the pavement structure. Patches are constructed for a variety of reasons including utility repairs, correcting grade issues, and addressing a defect in the original pavement.

The severity level of patches is determined by the amount of distress (i.e. cracking, depression, weathering/raveling, etc.) occurring within the limits of the patched area.

Example of Rutting



Ruts are localized, load related, areas of pavement having elevations lower than the surrounding sections. Rutting is due to base and subgrade consolidation, caused by

excessive wheel loads or poor compactions. Ruts indicate structural failure, and can cause hydroplaning. At low severity, ruts have an average depth of ¼ to ½ inches. At medium severity, ruts have an average depth of ½ to 1 inch. High severity, ruts have an average depth greater than 1 inch.

Full-depth patching is the appropriate repair for ruts.

Rigid Pavement Distress

Example of Longitudinal, Transverse, and Diagonal Cracking



LTD cracking is most often a result of externally applied loads and/or constrained temperature deformations. External loads cause LTD cracking through flexure. Temperature changes on restrained slabs will result in stresses due to friction or curling. When any of these stresses exceed the strength of the slab, cracking will occur. LTD cracking is recorded at low, medium, or high severity, depending on the width of crack opening and degree of deterioration. At low severity, the crack is less than 1/8th inch wide with little spalling and no corrective action is indicated. At medium severity, LTD cracks can be up to 1 inch wide with moderate spalling, and should be repaired and sealed using procedures similar to joint sealing. At high severity, cracks exceed 1 inch in width and may be severely spalled. High-severity LTD cracking is evidence of serious load failure of the slab, and correction may require patching or slab replacement. If the distress occurs in several adjacent slabs at medium or high severity, major rehabilitation of that pavement area is indicated.

When a slab is divided by LTD cracks into four or more pieces, the slab is said to be "divided" or "shattered." Shattered slab is a separate distress category and is indicative of significant structural failure as the slab loses its ability to distribute loads to subgrade and further slab deterioration can be expected. Shattered slabs are rated in three severities, with slab replacement recommended for medium and high severities.

Example of Shrinkage Cracking



Shrinkage cracks are small, nonworking (no spalling along edge) cracks that are visible at the surface but do not penetrate through the full depth of concrete. Shrinkage cracks most commonly occur shortly after construction due to concrete shrinkage during the curing process. Shrinkage cracks are usually so small that they are not visible until staining or material loss at crack edges begins to take place. Shrinkage cracks do not represent a structural weakness, and no corrective action is prescribed.

Example of Joint and Corner Spalling



Spalls at slab joints and corners are caused by excessive internal stress in the pavement. Spalls occur when these stresses exceed the shear strength of the concrete. Spalling usually results from thermal expansion during warm or hot weather. As slabs expand, they push against one another at joints. If the joints are filled with incompressibles, such as sand, or if adjacent slabs offset slightly, stresses can become severe, causing spalls. Spalling can be reduced significantly by conscientious maintenance of joint sealant.

Spall repair requires patching. The extent and severity of spalling on a pavement surface suggests appropriate action. For example, at low severity, spalled concrete remains securely in place in the slab. A low-severity spall should be monitored closely for further

deterioration and should be patched when spalled particles become loose in place, or at the next scheduled patching activity in the section. Medium- and high-severity spalls should be repaired immediately to prevent the incidence of FOD. If the pavement can be restored to serviceable condition, spalls should be carefully patched for long-term service. If the pavement is beyond repair, temporary patching should be considered to control FOD.

Example of Durability Cracking



Durability cracking (D-cracking) is caused by environmental factors, the most common of which is freezing/thawing. It usually appears as a pattern of hairline cracks running parallel to a joint or crack, or in a corner, where water tends to collect. This type of cracking eventually leads to disintegration of the pavement, creating FOD potential. At low severity, D-cracking is evident, but no disintegration has occurred. As the distress advances to medium severity, the distress pattern is evident over a significant area of the slab, and some disintegration and FOD potential exists. High severity durability cracking is evidenced by extensive cracking with loose and missing pieces and significant FOD potential.

Example of Joint Seal Damage



Joint seal damage is recorded at three severities: low, medium, and high. When joint sealant is in perfect condition (no damage), it is not a distress. At low severity, at least 10 percent of the sealant is debonded but still in contact with the joint edges (i.e., joint sealant is in serviceable condition but should be monitored for evidence of more serious failure). Medium-severity joint seal damage is recorded when at least 10 percent of the sealant has visible gaps smaller than 1/8th inch and is an indicator that replacement should be programmed as soon as is practicable. In the mean time, aggressive inspection and sustaining maintenance is recommended to minimize subsurface damage from moisture penetration. At high severity, visible gaps exceed 1/8th inch and the amount and degree of joint seal damage is such that repair is no longer feasible. The only appropriate corrective action is sealant replacement.

On serviceable pavement, deteriorated joint sealant should be repaired or replaced to preserve pavement and subgrade integrity and prolong service life. The issue is not so clear-cut with unserviceable pavement. Pavement that can be restored to serviceable condition by maintenance activities such as patching and joint seal repair, or by slab replacement, should be so maintained as long as the process is cost-effective. However, when age and condition preclude economical return to serviceable condition by such means, joint seal repair would no longer be cost-effective and should be suspended except for an interim maintenance program to control FOD potential.

Joint sealant can stop the evidence of pumping (water forced to surface through joints and cracks) but will not correct the cause (voids under pavement).

This page intentionally left blank.

Appendix E

Maintenance and Major Rehabilitation Policies

Table 1. Localized maintenance policy for asphalt surfaces.

Distress type	Distress severity	Maintenance treatment
Alligator cracking	Low	Crack Sealing - AC
	Medium	Patching - AC Deep
	High	Patching - AC Deep
Bleeding	N/A	Monitor
Block cracking	Low	Monitor
	Medium	Crack Sealing - AC
	High	Crack Sealing - AC
Corrugation	Low	Monitor
	Medium	Patching - AC Deep
	High	Patching - AC Deep
Depression	Low	Monitor
	Medium	Patching - AC Shallow
	High	Patching - AC Deep
Jet blast	N/A	Patching - AC Shallow
Joint reflection cracking	Low	Monitor
	Medium	Crack Sealing - AC
	High	Crack Sealing - AC
Longitudinal & transverse cracking	Low	Monitor
	Medium	Crack Sealing - AC
	High	Crack Sealing - AC
Oil spillage	N/A	Patching - AC Shallow
Patching	Low	Monitor
	Medium	Crack Sealing - AC
	High	Patching - AC Deep
Polished aggregate	N/A	Monitor
Weathering/raveling	Low	Monitor
	Medium	Surface Treatment
	High	Patching - AC Shallow
Rutting	Low	Monitor
	Medium	Patching - AC Deep
	High	Patching - AC Deep
Shoving	Low	Monitor
	Medium	Patching - AC Shallow
	High	Patching - AC Deep
Slippage cracking	N/A	Patching - AC Shallow
Swelling	Low	Monitor
	Medium	Patching - AC Deep
	High	Patching - AC Deep

Table 2. Localized maintenance policy for PCC surfaces.

Distress type	Distress severity	Maintenance treatment
Blow up	Low	Patching - PCC Partial Depth
	Medium	Slab Replacement - PCC
	High	Slab Replacement - PCC
Corner break	Low	Monitor
	Medium	Patching - PCC Full Depth
	High	Patching - PCC Full Depth
Linear cracking	Low	Monitor
	Medium	Crack Sealing - PCC
	High	Patching - PCC Full Depth
Durability cracking	Low	Monitor
	Medium	Patching - PCC Full Depth
	High	Slab Replacement - PCC
Joint seal damage	Low	Monitor
	Medium	Joint Seal (Localized)
	High	Joint Seal (Localized)
Small patch	Low	Monitor
	Medium	Patching - PCC Partial Depth
	High	Patching - PCC Partial Depth
Large patch	Low	Monitor
	Medium	Patching - PCC Full Depth
	High	Patching - PCC Full Depth
Popouts	N/A	Monitor
Pumping	N/A	Monitor
Scaling	Low	Monitor
	Medium	Patching - PCC Partial Depth
	High	Slab Replacement - PCC
Faulting	Low	Monitor
	Medium	Grinding (Localized)
	High	Grinding (Localized)
Shattered slab	Low	Monitor
	Medium	Crack Sealing - PCC
	High	Slab Replacement - PCC
Shrinkage cracking	N/A	Monitor
Joint spall	Low	Monitor
	Medium	Patching - PCC Partial Depth
	High	Patching - PCC Partial Depth
Corner spall	Low	Monitor
	Medium	Patching - PCC Partial Depth
	High	Patching - PCC Partial Depth

Table 3. Unit costs for localized maintenance treatments.

Treatment name	Unit cost
Crack Sealing - AC	\$1.02 ft
Crack Sealing - PCC	\$1.53 ft
Grinding (Localized)	\$4.00 ft
Joint Seal (Localized)	\$1.53 ft
Patching - AC Deep	\$9.49 sf
Patching - AC Leveling	\$3.32 sf
Patching - AC Shallow	\$6.37 sf
Patching - PCC Full Depth	\$59.59 sf
Patching - PCC Partial Depth	\$8.57 sf
Slab Replacement - PCC	\$32.09 sf
Surface Treatment	\$0.42 sf
Undersealing - PCC	\$2.54 ft

Table 4. Major rehabilitation unit costs based on PCI ranges.

PCI range	Cost
0-29	\$7.00 sf
30-39	\$5.75 sf
40-49	\$4.75 sf
50-59	\$3.25 sf
60-69	\$2.00 sf
> 70	\$1.00 sf

Appendix F

Localized Maintenance Recommendations

Table F.1. Recommended maintenance by section report (HCD).

Branch ID	Section ID	Distress Type	Severity	Treatment	Estimated Quantity	Unit	Cost
APB	1	ALLIGATOR CR	L	Crack Sealing - AC	128	Ft	\$130
APB	1	L & T CR	M	Crack Sealing - AC	1,784	Ft	\$1,820
APB	2	JT SEAL DMG	M	Joint Seal (Localized)	440	Ft	\$673
CTB	1	ALLIGATOR CR	L	Crack Sealing - AC	22	Ft	\$22
CTB	1	L & T CR	H	Crack Sealing - AC	55	Ft	\$56
CTB	1	L & T CR	M	Crack Sealing - AC	304	Ft	\$310
CTC	1	ALLIGATOR CR	L	Crack Sealing - AC	10	Ft	\$10
CTC	1	L & T CR	M	Crack Sealing - AC	71	Ft	\$73
CTC	1	L & T CR	H	Crack Sealing - AC	219	Ft	\$223
CTCX	1	L & T CR	H	Crack Sealing - AC	243	Ft	\$248
CTCX	1	L & T CR	M	Crack Sealing - AC	81	Ft	\$83
CTD	1	L & T CR	M	Crack Sealing - AC	271	Ft	\$276
CTD	1	L & T CR	H	Crack Sealing - AC	110	Ft	\$112
PTA	1	ALLIGATOR CR	L	Crack Sealing - AC	16	Ft	\$17
PTA	1	L & T CR	H	Crack Sealing - AC	7	Ft	\$7
PTA	1	L & T CR	M	Crack Sealing - AC	274	Ft	\$280
PTA	2	L & T CR	M	Crack Sealing - AC	710	Ft	\$725
PTA	3	ALLIGATOR CR	L	Crack Sealing - AC	295	Ft	\$301
PTA	3	L & T CR	M	Crack Sealing - AC	1,505	Ft	\$1,535
PTA	3	L & T CR	H	Crack Sealing - AC	3,192	Ft	\$3,256
RY1533	1	ALLIGATOR CR	L	Crack Sealing - AC	21	Ft	\$21
RY1533	1	L & T CR	H	Crack Sealing - AC	8,963	Ft	\$9,142
RY1533	1	L & T CR	M	Crack Sealing - AC	969	Ft	\$989
RY1533	1	ALLIGATOR CR	M	Patching - AC Deep	127	SqFt	\$1,208
TLA	1	L & T CR	M	Crack Sealing - AC	665	Ft	\$678
TLA	1	ALLIGATOR CR	M	Patching - AC Deep	266	SqFt	\$2,527
TLA	2	L & T CR	M	Crack Sealing - AC	141	Ft	\$144
TLA	3	ALLIGATOR CR	L	Crack Sealing - AC	75	Ft	\$77
TLA	3	L & T CR	M	Crack Sealing - AC	1,384	Ft	\$1,412
TLA	3	ALLIGATOR CR	M	Patching - AC Deep	227	SqFt	\$2,153

Branch ID	Section ID	Distress Type	Severity	Treatment	Estimated Quantity	Unit	Cost
TLA	3	WEATH/RAVEL	H	Patching - AC Shallow	34	SqFt	\$217
TLA	3	WEATH/RAVEL	M	Surface Treatment	107	SqFt	\$45
TLA	4	LINEAR CR	M	Crack Sealing - PCC	10	Ft	\$15
TLA	4	SHAT. SLAB	M	Crack Sealing - PCC	140	Ft	\$214
TLA	4	FAULTING	M	Grinding (Localized)	10	Ft	\$40
TLA	4	JT SEAL DMG	H	Joint Seal (Localized)	1,120	Ft	\$1,714
TLA	4	CORNER BREAK	M	Patching - PCC Full Depth	194	SqFt	\$11,546
TLA	4	CORNER BREAK	H	Patching - PCC Full Depth	65	SqFt	\$3,849
TLA	4	SMALL PATCH	M	Patching - PCC Partial Depth	5	SqFt	\$46
TLA	4	JOINT SPALL	M	Patching - PCC Partial Depth	7	SqFt	\$55
TLA	5	L & T CR	M	Crack Sealing - AC	168	Ft	\$171
TLB	1	L & T CR	M	Crack Sealing - AC	881	Ft	\$899
Airport Total							\$47,316

Table F.2. Recommended maintenance by treatment report (HCD).

Branch ID	Section ID	Distress Type	Severity	Treatment	Estimated Quantity	Unit	Cost
APB	1	ALLIGATOR CR	L	Crack Sealing - AC	128	Ft	\$130
APB	1	L & T CR	M	Crack Sealing - AC	1,784	Ft	\$1,820
CTB	1	ALLIGATOR CR	L	Crack Sealing - AC	22	Ft	\$22
CTB	1	L & T CR	H	Crack Sealing - AC	55	Ft	\$56
CTB	1	L & T CR	M	Crack Sealing - AC	304	Ft	\$310
CTC	1	ALLIGATOR CR	L	Crack Sealing - AC	10	Ft	\$10
CTC	1	L & T CR	M	Crack Sealing - AC	71	Ft	\$73
CTC	1	L & T CR	H	Crack Sealing - AC	219	Ft	\$223
CTCX	1	L & T CR	H	Crack Sealing - AC	243	Ft	\$248
CTCX	1	L & T CR	M	Crack Sealing - AC	81	Ft	\$83
CTD	1	L & T CR	M	Crack Sealing - AC	271	Ft	\$276
CTD	1	L & T CR	H	Crack Sealing - AC	110	Ft	\$112
PTA	1	ALLIGATOR CR	L	Crack Sealing - AC	16	Ft	\$17
PTA	1	L & T CR	H	Crack Sealing - AC	7	Ft	\$7
PTA	1	L & T CR	M	Crack Sealing - AC	274	Ft	\$280
PTA	2	L & T CR	M	Crack Sealing - AC	710	Ft	\$725
PTA	3	ALLIGATOR CR	L	Crack Sealing - AC	295	Ft	\$301
PTA	3	L & T CR	M	Crack Sealing - AC	1,505	Ft	\$1,535
PTA	3	L & T CR	H	Crack Sealing - AC	3,192	Ft	\$3,256
RY1533	1	ALLIGATOR CR	L	Crack Sealing - AC	21	Ft	\$21
RY1533	1	L & T CR	H	Crack Sealing - AC	8,963	Ft	\$9,142
RY1533	1	L & T CR	M	Crack Sealing - AC	969	Ft	\$989
TLA	1	L & T CR	M	Crack Sealing - AC	665	Ft	\$678
TLA	2	L & T CR	M	Crack Sealing - AC	141	Ft	\$144
TLA	3	ALLIGATOR CR	L	Crack Sealing - AC	75	Ft	\$77
TLA	3	L & T CR	M	Crack Sealing - AC	1,384	Ft	\$1,412
TLA	5	L & T CR	M	Crack Sealing - AC	168	Ft	\$171
TLB	1	L & T CR	M	Crack Sealing - AC	881	Ft	\$899
Total Crack Sealing – AC quantity					22,563 Ft		\$23,014
TLA	4	LINEAR CR	M	Crack Sealing - PCC	10	Ft	\$15
TLA	4	SHAT. SLAB	M	Crack Sealing - PCC	140	Ft	\$214
Total Crack Sealing - PCC quantity					150 Ft		\$229

Branch ID	Section ID	Distress Type	Severity	Treatment	Estimated Quantity	Unit	Cost
TLA	4	FAULTING	M	Grinding (Localized)	10	Ft	\$40
Total Patching – Grinding (Localized) quantity					10	SqFt	\$40
APB	2	JT SEAL DMG	M	Joint Seal (Localized)	440	Ft	\$673
TLA	4	JT SEAL DMG	H	Joint Seal (Localized)	1,120	Ft	\$1,714
Total Joint Seal (Localized) quantity					1,560	Ft	\$2,387
RY1533	1	ALLIGATOR CR	M	Patching - AC Deep	127	SqFt	\$1,208
TLA	1	ALLIGATOR CR	M	Patching - AC Deep	266	SqFt	\$2,527
TLA	3	ALLIGATOR CR	M	Patching - AC Deep	227	SqFt	\$2,153
Total Patching – AC Deep quantity					621	SqFt	\$5,889
TLA	3	WEATH/RAVEL	H	Patching - AC Shallow	34	SqFt	\$217
Total Patching - AC Shallow quantity					34	SqFt	\$217
TLA	4	CORNER BREAK	M	Patching - PCC Full Depth	194	SqFt	\$11,546
TLA	4	CORNER BREAK	H	Patching - PCC Full Depth	65	SqFt	\$3,849
Total Patching – PCC Full Depth quantity					259	SqFt	\$15,395
TLA	4	SMALL PATCH	M	Patching - PCC Partial Depth	5	SqFt	\$46
TLA	4	JOINT SPALL	M	Patching - PCC Partial Depth	7	SqFt	\$55
Total Patching – PCC Partial Depth quantity					12	SqFt	\$101
TLA	3	WEATH/RAVEL	M	Surface Treatment	107	SqFt	\$45
Total Surface Treatment quantity					107	SqFt	\$45
Airport Total							\$47,316

Appendix G

Maintenance Repair Guidelines

MAINTENANCE REPAIR GUIDELINES

General Comments

Ongoing inspections are the cornerstone of a maintenance management program. Crack sealing prevents surface water from entering the pavement structure and helps prevent the introduction of incompressible material into the paving joints and cracks, reducing the chances for spalls and further pavement deterioration.

Preservation of a pavement system will require a combination of preventive, sustaining, and restorative maintenance repairs. Preventive maintenance is primarily an inspection program, sustaining maintenance is an ongoing maintenance function, whose purpose is to seal newly formed cracks in areas where the sealant is in otherwise satisfactory condition. Restorative repairs are major work items, often performed under contract that typically involves complete removal and replacement of existing sealant.

Maintenance Activities

Flexible Pavement

Longitudinal and transverse (L&T) cracks at medium severity ($>1/4$ " wide) should be filled with a good quality crack filler material. High-severity cracks must normally be patched. Cracks rated at low severity may be narrow-unsealed cracks or sealed cracks up to 3 inches wide. The PCI procedure does not distinguish between narrow unfilled cracks and wider filled cracks. When 25 percent or more of total crack quantity is at medium or high severity, a restorative program becomes cost-effective. When medium- or high-severity cracking constitutes less than 25 percent of the total, sustaining maintenance is usually more cost-effective.

Medium- and high-severity existing patches should be replaced with new patches. Small areas (usually less than 100 square feet per patch) of alligator cracking and rutting at medium and high severity may also be repaired by patching. Larger patches should be considered if equipment can be made available to accomplish the work. Patching to repair up to 10 percent of the surface of a pavement feature that is otherwise serviceable can result in significant cost savings as compared to rehabilitation of the entire feature.

PCC Pavement

Joint seal damage at medium and high severity should be repaired. If medium- and high-severity damage is limited to less than about 25 percent of total joint length, sustaining maintenance is recommended. If medium and high-severity damage exceeds about 25 percent of the total joint length, joint sealant should be removed and replaced under a restorative repair project.

Longitudinal/transverse/diagonal (LTD) cracks at low and medium severity should be considered for sealing as part of the joint sealing project. High-severity LTD cracks require sealing, patching, or slab replacement, depending on the extent of deterioration.

Small patches are most often placed to repair medium- and high-severity spalls or to replace deteriorated older patches. Restorative small patches are typically partial depth repairs, usually to load transfer steel. Large patches and corner breaks at medium and high severity should be repaired by full-depth large patches.

High-severity LTD cracks and shattered slabs are candidates for patching and slab replacement. Low-severity shattered slabs can be left in place pending further deterioration.

Pavement Failure

Before maintenance and repairs are attempted, it helps to have an understanding of the way pavement performs and deteriorates.

Environmental/Age-Related Deterioration

Seasonal temperature changes cause expansion and contraction of the pavement materials, causing the pavement to move up to 1 foot per 1,000 feet. Much of this movement can be witnessed as the opening and closing of existing transverse cracks.

The pavement thickness and type of subgrade plays a large roll in the formation and spacing interval of transverse cracks. If the subgrade material is smooth or rounded, the pavement surface will move relatively freely, the transverse cracks will usually be spaced far apart (>60 feet). If the subgrade material is rough or angular the pavement surface will not move freely and transverse cracks will be spaced more closely (<40 feet). The distance between transverse cracks will also depend on the pavement thickness, as a thicker pavement can resist cracking for longer lengths, but around 50 feet is typical for general aviation airport pavements.

Age related distress deals with the pavement oxidation or loss of volatile components to the atmosphere. An oxidized pavement becomes more brittle with time. Surface treatments and seal coats are designed, in part, to provide a protective barrier and prevent this type of oxidation.

Materials Related Deterioration

Subsurface water can have the greatest impact on pavement deterioration. A wet subgrade greatly reduces the ability of a pavement to support wheel loads, and the results often show up as rutting and cracking. The fine materials in a wet base can be pumped up through the cracks and eventually result in a loss of subgrade support. This loss of support can be evidenced as corner breaks and faulting. Moisture inside a pavement system expands when it freezes, creating stresses that push and tear at the pavement. The following thaw cycles will leave voids in the pavement structure that enable further rutting and breaking. Repeated freeze/thaw cycles will eventually cause pavement to

disintegrate. One of the best ways to assure pavement longevity is to provide drainage and keep it dry.

Aggregate is the biggest component of any pavement structure, and it is the contact between the aggregate particles that actually transfers the load and provides the strength. Aggregate durability and shape are major factors affecting pavement performance. Durability is the ability of the aggregate to perform satisfactorily over time and resist the detrimental effect of nature. Sharp, well-angled aggregate that interlock, compact densely, and resists movement are the most desirable.

Air Voids

Well-distributed interconnected air voids allow escape paths for freezing water and generally reduce susceptibility to freeze/thaw damage. In PCC pavements, closely spaced interconnected air voids provide the greatest degree of protection.

Asphalt pavements, on the other hand, only tolerate air voids as necessary. Air voids allow for expansion of the asphalt binder, but also allow water penetration into the pavement. Interconnected air voids are undesirable here because the voids allow air to penetrate the asphalt layers and oxidize the binder. As air voids increase, durability and flexibility decrease, but stability and skid resistance increase. Asphalt pavements should be designed and compacted so that air voids are not interconnected. The air voids should allow only for the expansion of the asphalt and aggregate without, bleeding, and air voids should be kept low enough to prevent water and air from penetrating the asphalt layers.

Binders

Regardless of whether the pavement is asphalt or concrete, the binder material is mixed with the aggregate to coat all particles with a thin film. An asphalt coating allows the pavement to be flexible and still resist large movements. Durability of the asphalt pavement is increased by a thicker film because it is more resistant to age hardening; however, too thick of a film and the asphalt acts like a lubricant, promoting ruts, shoving, and bleeding. Specifications control aggregate and binder mix quantities, but each mix should be customized for materials available locally.

With a concrete pavement, the aggregate supports the load, but the cement binder interlocks with the aggregate to inhibit all movement. Hydration is the term for the chemical reaction of portland cement with water, and in the hydration process, dry cement particles react with water, to form gels, and then crystals, that grow and bond with the aggregate to form a rigid interlocking structure. Hydration can continue for years, but much of the ultimate strength will be reached within 28 days. Hydration is a sensitive chemical process, and typically, any admixtures used to accelerate the hydration process will reduce durability, and their use should be considered carefully or avoided.

Stress Distribution / Load Related Deterioration

PCC (rigid) and asphalt (flexible) pavements differ in the way loads are distributed. A concrete slab resists bending and transfers loads evenly, an asphalt pavement is designed

to bend, and gradually spreads loads over wider areas. Rutting is a subgrade failure caused by a compressive yielding of the subgrade.

Load-related cracks can start at the top or bottom of a pavement section. In asphalt sections, load-related (fatigue) cracks start at the bottom. If a load-related crack reaches the surface, it usually indicates significant structural deficiency. In PCC pavement, corner breaks are caused by top tension, and the crack propagates downward. Mid-slab LTD cracks are examples of bottom tension.

Spalls can be caused by either wheel loads or environmental factors, anytime there is movement between adjacent slabs. If a small rock is allowed into a joint, a differential movement between adjacent slabs can cause a spall. Spalling can be minimized by keeping joint and crack sealant intact.

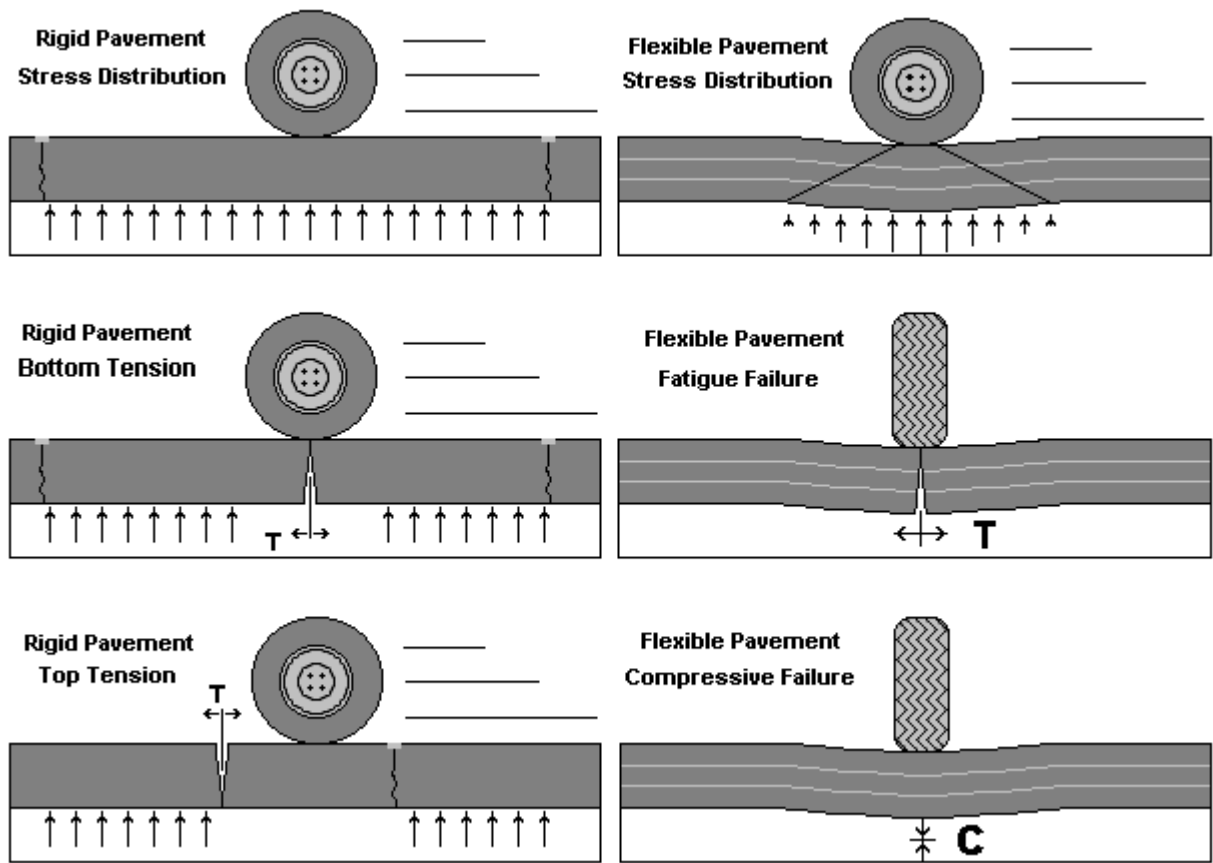

Figure 1. Pavement failure.

Points to Remember

1. Pavement wears out.

The longer a pavement remains in service, the greater the effort needed to keep it in service. A good maintenance and repair program will increase service life significantly, but cannot be expected to extend service life indefinitely.

2. Pavement moves.

Pavement moves in response to temperature changes. Transverse cracks can vary from nearly closed in the summer to open an inch or more in winter. This movement cannot be prevented. It must be understood and provided for during design and construction. The changing crack widths will dictate the reservoir size required for sealant. Measure cracks at their widest and narrowest states, then prepare adequate (½ - 1½ inch) sealant reservoirs for crack sealing projects.

3. Longitudinal joints and cracks are important.

The most important reason for sealing cracks is to deny surface water access to the pavement and subgrade. Most water drains from centerline to shoulders. Longitudinal cracks, which run parallel to the centerline provide the greatest potential to divert water into the pavement structure, and must be sealed.

4. Sealing is not always the best answer.

The FAA maximum allowable open trench width on aircraft movement areas is three-inches; therefore, any crack wider than three-inches should be patched. A severe spall or a crack that has settled below the pavement elevation indicates a failure. If the pavement has disintegrated to the point that aggregate interlock is lost, sealant alone will not be sufficient, and patching should be considered.

5. Maintenance and repairs must be done correctly.

To achieve optimum results from repairs, proper preparation, use of quality materials, and proper application are essential. Any shortcuts will reduce the quality and effectiveness of the repairs. A rule of thumb is that proper maintenance will last twice as long as an unprepared area. Good maintenance takes time and deserves high-quality materials.

6. Schedule maintenance and repair activities carefully.

Any pavement defect can be corrected. Concentrate on repairs that are cost-effective, operationally important, and that extend service life. Some surface blemishes can be ignored safely, and many structural problems are beyond economical correction. When future rehabilitation is imminent, maintenance activities should be limited to only those that ensure continued safety and minimize foreign object damage (FOD) potential.

Equipment

Many excellent pavement repair and sealing products are available. Specialized tools and equipment help ensure quality repairs. This section reviews equipment compatible with airport needs.

Air Compressor

Used to remove sand and debris from prepared cracks and joints, the compressor should have a sustained capacity of 120 cubic feet per minute with a nozzle velocity of 100 psi. Trailer-mounted compressors typically have capacities in this range.

Concrete Saw

A saw capable of making a minimum 3-inch deep cut is required. The saw should be capable of making cuts in asphalt or concrete. Gasoline-powered 5-25 hp wheel mounted saws typically are preferred for this type of work, but electric and pneumatic tools are also available.

Heating Kettle

Applying sealant is the most time-consuming operation, and a sealing machine with heating and pressure application capabilities is a critical item in a sealing program. The capacity of the sealing equipment dictates the rate at which a crew progresses. For large sealing projects, a minimum 100 gallons/per hour sustained capacity is recommended. The unit should be a double boiler type, with mechanical agitators or continuous recirculation.

Router

A concrete saw can be used to prepare joints, but for random cracking, a mechanical router with a vertical impact mechanism is preferred. When cracks are being routed, this activity will dictate speed of the crew. Crack routers in the 25hp range are commonly used and are available from a variety of manufacturers.

Sand Cleaner

A sand blaster helps to clean loose particles and dust from prepared cracks. The unit must have sufficient force to expose fresh, vital pavement to bond with sealant and patching materials.

Vibratory Roller or Plate Compactor

Required to properly compact plant mixed and packaged patching materials. Small rollers are best for pothole type applications, plate compactors are best for large areas.

Other Equipment

Other general use equipment that can be helpful in a maintenance program includes bucket loaders, dump trucks, water tanks, and a power sweeper unit.

Materials

Pavement repair materials are constantly being introduced and improved. This section provides information on products compatible with airport needs.

Joint and Crack Sealer

Hot poured, pressure injected, polymeric rubberized asphalt sealant meeting ASTM D3405 specifications is suitable for most joint and crack sealing requirements. This product is relatively inexpensive, durable, and suitable for both PCC and asphalt pavements. Other, more expensive, hot applied sealants that promise longer life are being developed for specialty applications, and twin component cold applied sealants, similar to URASEAL 200, have also been used with success. Contact your local distributor.

Flexible Pavement Patch

Long-term patches should be made with a high-quality plant mixed hot asphalt having a ¾-inch maximum aggregate size and meeting FAA P401, or highest quality highway specifications. High-performance plant mixed cold patching products that can be stockpiled on-site have been developed. Low-quality packaged materials available from local hardware type stores should be avoided and only be used for temporary patches that maintain safety and service.

PCC Pavement Patch

Permanent patches in PCC pavement should be made with a minimum 6-bag mix of high early air-entrained cement with 1-inch maximum size aggregate. Concrete should have zero slump and a coarse texture. As with asphalt patches, low-quality packaged materials should only be used as temporary patches to maintain safety and service until a more permanent repair can be made.

Techniques

Crack Sealing

- Cracks over ¼ inches wide should be sealed. Cracks wider than 3 inches should be patched.
- Sealant depth above the backer rope should be equal to the width of the reservoir, or as recommended by the manufacturer.
- Routed cracks should be sand blasted, to prepare the vertical edges for bonding with the sealant. Clean cracks with compressed air prior to sealing.
- Backing material should always be placed into the cracks. Commercial products are available, and several sizes of rope should always be available to accommodate various crack sizes.
- Apply sealant after placing the backer rope. Follow the manufacturer's instructions. Sealant should be applied to within ¼ inch of the pavement surface.
- The final activity is to clean the surrounding pavement areas. A vacuum sweeper works well for this. Allow the sealant time to set, before using a broom.

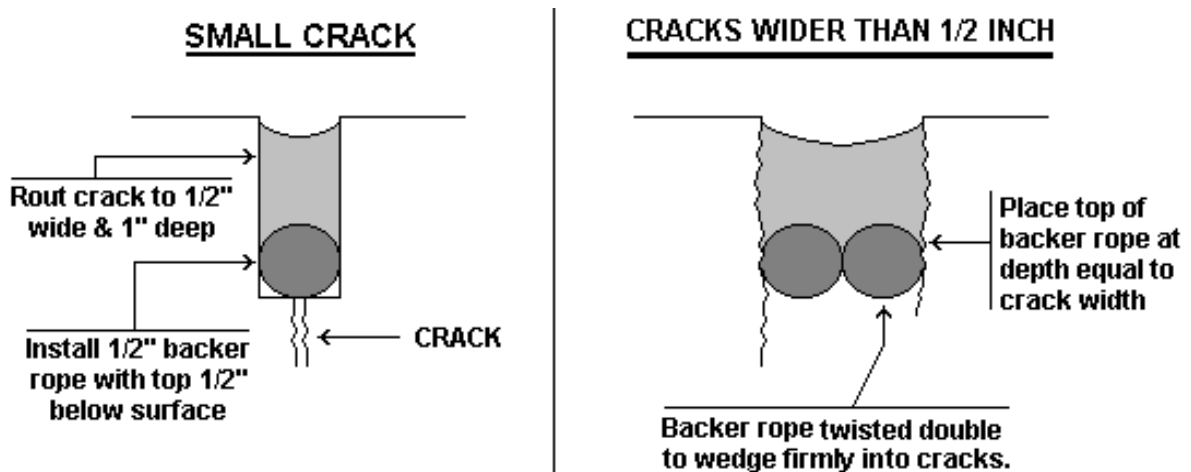

Figure 2. Crack sealing.

Note:

The previous crack sealing technique is meticulous in its design and procedure. It has a proven record of performance. Using backer rope forces the sealant into a predictable shape—narrow in the center and wide on the sides. This sealant profile allows the sealant to firmly bond with the vertical edges, yet stretch easily with pavement movement. In an effort to minimize labor requirements and reduce crack-sealing costs, an alternative procedure, the overband technique, is presented below. This procedure can produce good results for up to 5 years.

Always remember that, within reasonable limits, thinner sealant material will stretch more easily with the pavement movement, and stay bonded longer.

Overband Technique

A latex modified, fiber reinforced, asphalt cement sealant using the techniques outlined below.

Material

- Blend grade 20 or equivalent asphalt cement with latex rubber at 5 percent by weight of asphalt.
- Again, at 5 percent by weight of asphalt, add polyester fibers into agitator tank.
- Maintain blended asphalt temperature at least 20 degrees below flash point.
- Continuously recycle hot blended asphalt through pumps and hoses when heating kettle is in standby mode.

Application

- Sealant should be applied to dry pavement, with ambient temperatures above 40 degrees.
- Cracks should be sand cleaned and blown free of debris immediately before sealing.
- Application of sealant immediately follows cleaning of the crack.
- Sealant should be pressure applied from a wand-type applicator with a special "overband" nozzle.
- Seat the sealant with a steel-wheeled roller immediately after placement.
- In wider cracks, a backer rope is recommended to limit material quantities required.

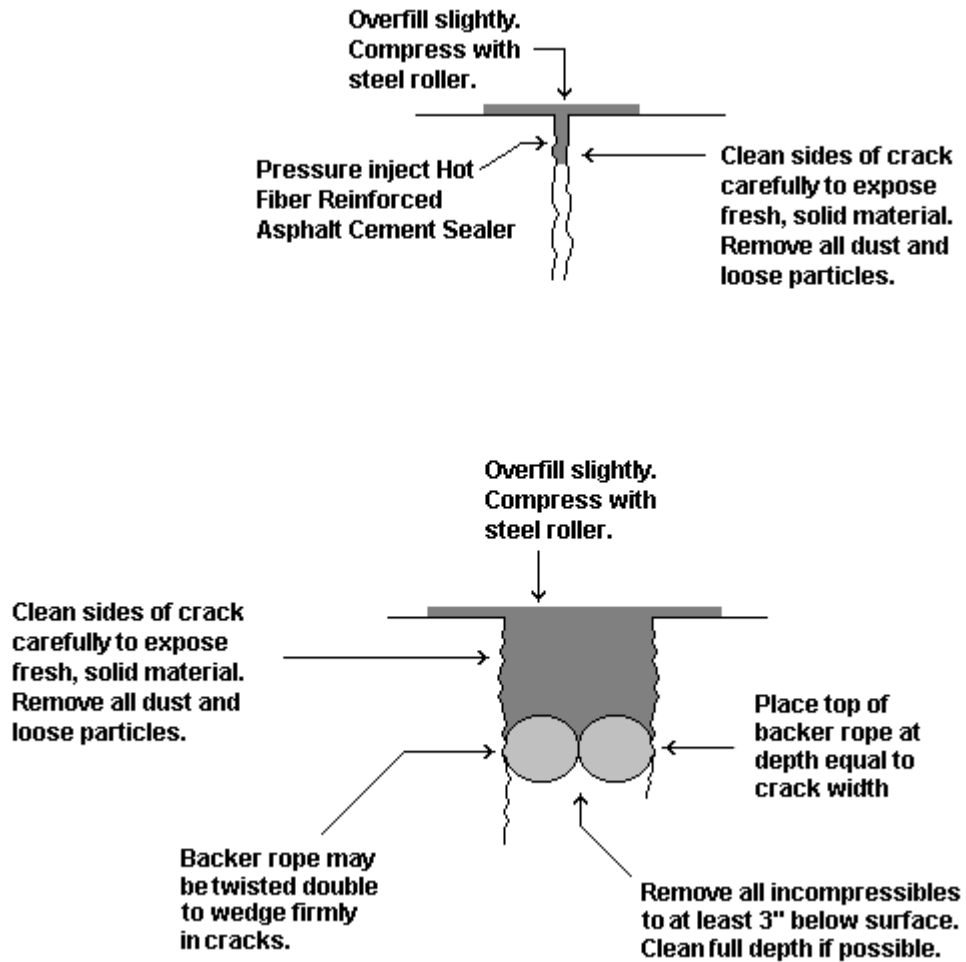

Figure 3. Overband sealing.

Patching (Asphalt Pavement)

Cracks wider than 3 inches should be patched. Cracks with secondary cracking and vertical movement should also be patched. Failed existing patches should be replaced. Patching can also repair small areas of alligator cracking and rutting. A patch differs from sealant in that it restores load-bearing capacity. Therefore, it must be constructed carefully to distribute stresses evenly and perform as an integral piece of the surrounding pavement. The patch must be wide enough to ensure that it bonds to fresh, vital pavement on all sides, and deep enough to reach fresh underlying layers, but never less than 3 inches.

- Examine the distressed area and mark the patch outline. This examination may require a pick or chisel to test the pavement integrity in and around the distressed area.
- The patch area should be cut out with a vertical saw cut not less than 3 inches deep.
- The enclosed pavement should then be removed, leaving the vertical sawed edges undamaged and providing a relatively even, flat floor at the appropriate depth.
- The sides and bottom should be sand cleaned and blown out with compressed air
- The sides and bottom should then be painted with a rapid curing asphalt tack coat. The tack coat may be sprayed on or applied with a brush or rag. Care should be taken to achieve complete coverage without allowing excess material to “pool” on the bottom.
- Allow tack coat to cure (about 2 to 4 hours) until it reaches a gummy consistency, which readily retains the impression of a fingerprint.
- Place hot mixed asphalt concrete evenly and mound slightly above surrounding pavement. Allow approximately ¼ inch of compaction for each inch of patch depth.
- Compact in place with vibratory roller or plate compactor. Asphalt concrete should not be compacted in layers greater than 6 inches. If patch depth is greater than 6 inches, asphalt concrete should be placed and compacted in successive layers.
- In deep, narrow patches such as at joint reflective cracks, a sand asphalt mix may be required in lower layers to allow movement and prevent bridging the adjacent slabs.
- Considerable judgment is required in placing the asphalt concrete to achieve a fully compacted patch without creating a bump or depression. The ¼ inch per inch factor is a rule of thumb. Actual compression will vary with the mix. Experimentation and experience are required to achieve optimum results.

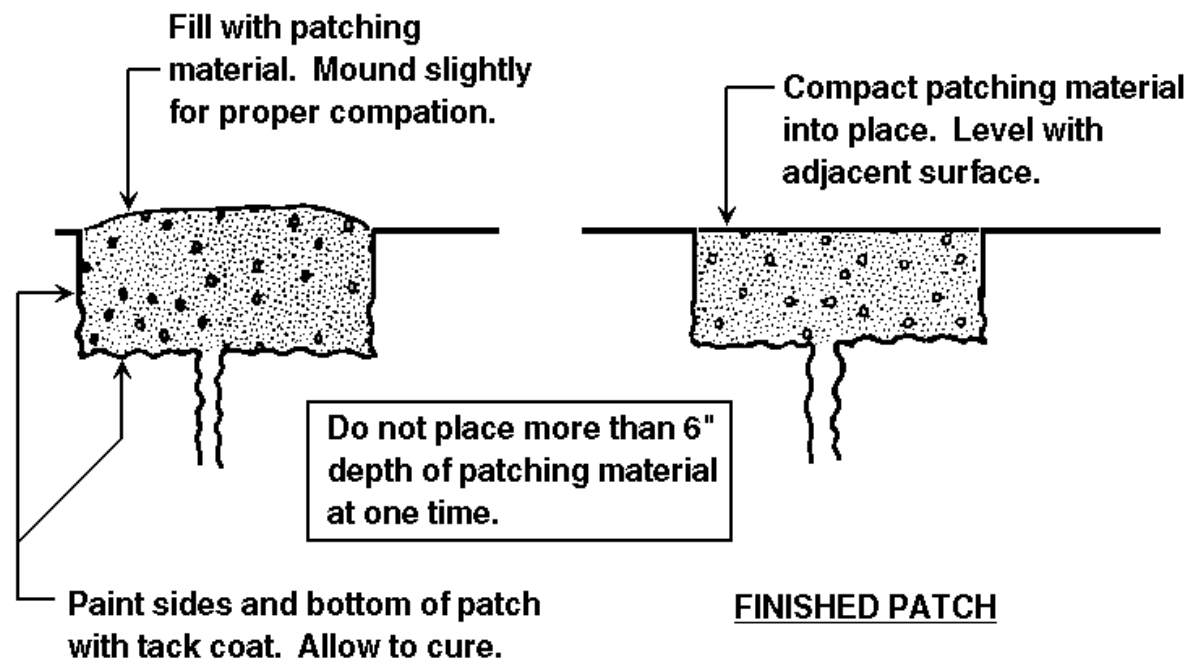
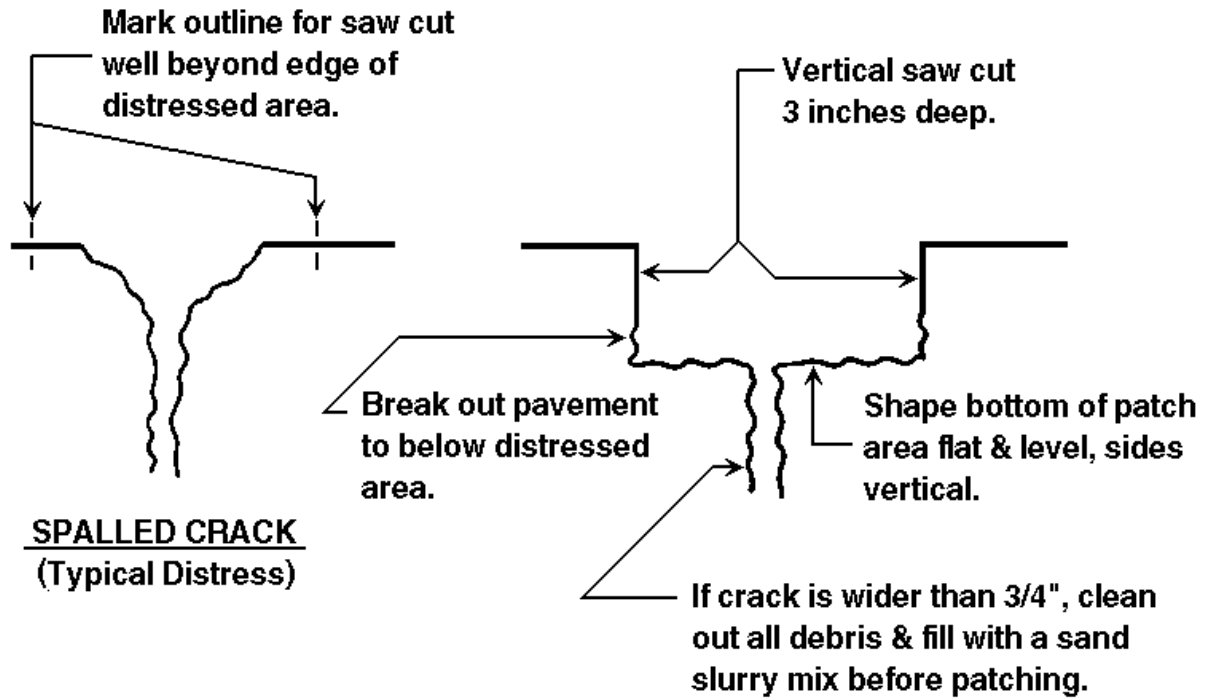

Figure 4. AC patch.

Patching (PCC)

The technique outlined here simulates a thin bonded PCC overlay. This procedure has been proven in service throughout the country.

- Examine the distressed area and mark the patch outline. This examination may require a pick or chisel to test pavement integrity in and around the distressed area.
- Saw cut the area to a depth of 2 inches. The enclosed area is then chipped or jack hammered to solid pavement, but not less than a 2-inch nominal depth.
- The sides and bottom are sand cleaned and air-blasted to expose vital, clean concrete.
- A 25 percent solution of muriatic acid is applied to all exposed surfaces within the patch.
- The muriatic acid solution is thoroughly flushed from the patch area with water.
- Compressed air is used to remove excess water from the area, but exposed concrete must be maintained in a moist condition.
- The sides and bottom of the area are then coated with approximately a 1/16-inch layer of cement grout applied at the consistency of paste. The grout acts as an adhesive to bond the fresh concrete to existing concrete.
- If the patch is adjacent to joints, the continuity of the joint must be maintained by placing inserts approximately the shape of the desired joint against the wall of the patch.
- Before concrete grout begins to dry, concrete is placed in the patch area and is compacted into position with hand tampers or a vibrating plate tamper.
- When the patch has been struck to the proper slope and elevation, a surface texture is applied to approximate the texture of adjacent pavement.
- Joint edges may be edged slightly to remove sharp edges. The patch should be covered with polyethylene or sprayed with a curing compound.
- Clean the surrounding pavement before concrete spillover has a chance to set up.
- The patch may be open to traffic in 72 hours.

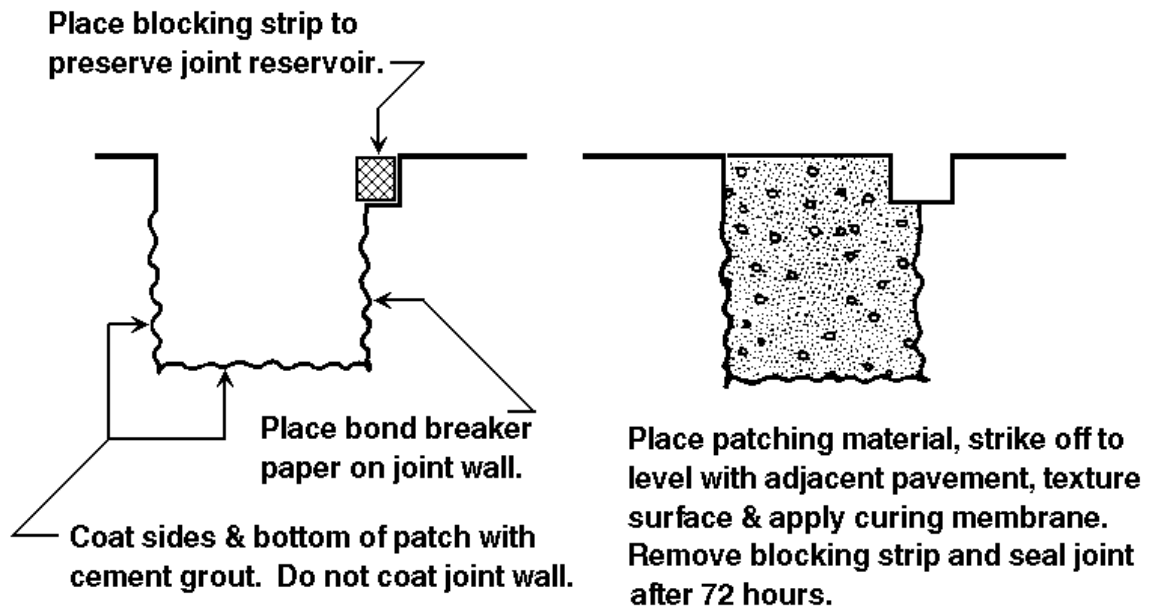
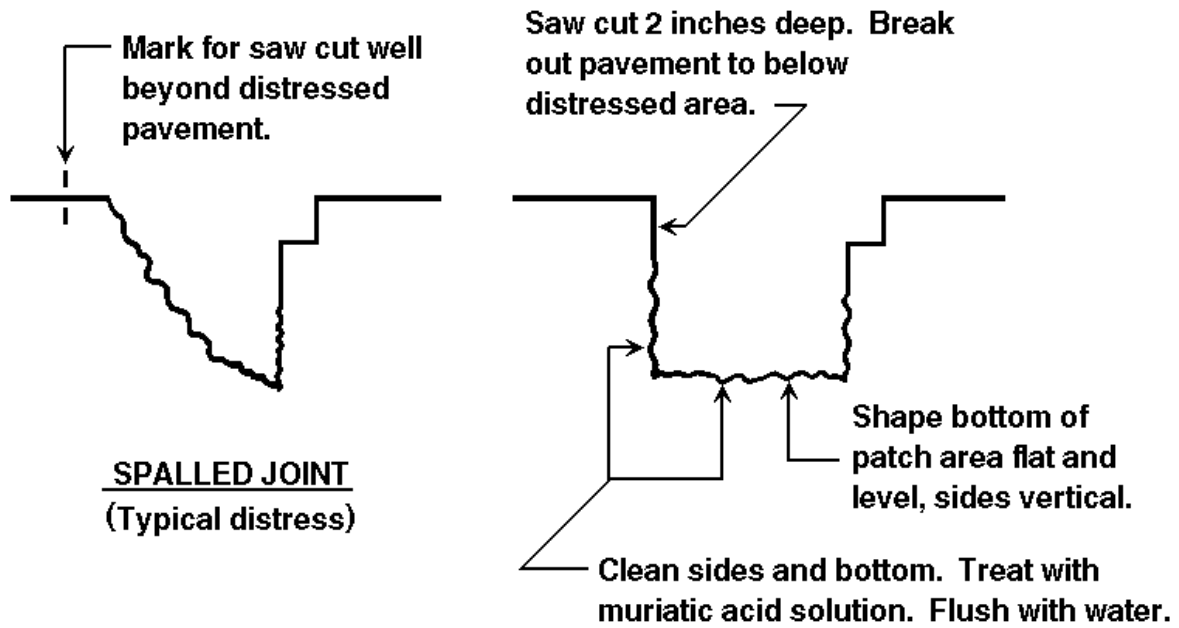
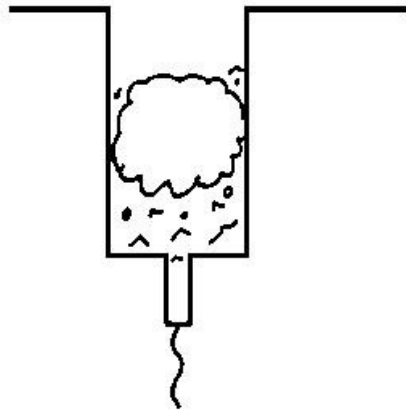

Figure 5. PCC patch.

Joint Repair (PCC)

Seal joints in PCC pavement when existing sealant has deteriorated to a degree that allows water and incompressibles to enter the joint. Hairline cracks are not yet candidates for sealing.

- Rout a reservoir for the sealant. Sealant reservoir should be ½ inch wide and 1 inch deep.
- For cracks wider than ½ inch, the reservoir should be ¼ inch wider than the crack. Depth should be such that sealant above the backer rope is at most equal to reservoir width, or as recommended by manufacturer.
- Routed cracks should be sand cleaned, using fine sand at reduced pressure. Proper cleaning will expose fresh, vital pavement on the vertical crack edge.
- Immediately prior to sealing, cracks should be cleaned with compressed air. Ensure that all sand, debris, and incompressibles are removed from the crack. A small hand-held hook or plowing tool may be needed to dislodge some particles. Water cleaning is not recommended, simply because the drying time delays the sealing operation.
- After cleaning with compressed air, a backing material should be placed into the crack. The backer rope may be any compressible substance compatible with bituminous sealant material that will wedge into cracks at a designated depth and support the sealant. Several sizes should be immediately available in the field to accommodate various crack sizes.
- Sealant should be pressure applied with a wand type applicator to within ¼ inch of the pavement surface. Follow the equipment manufacturer's instructions.
- The final activity is to clean the surrounding pavement area. A vacuum sweeper works well. Brooms should not be used until the sealant has taken an initial set.



Typical joint with deficient sealant and a collection of debris & incompressibles.

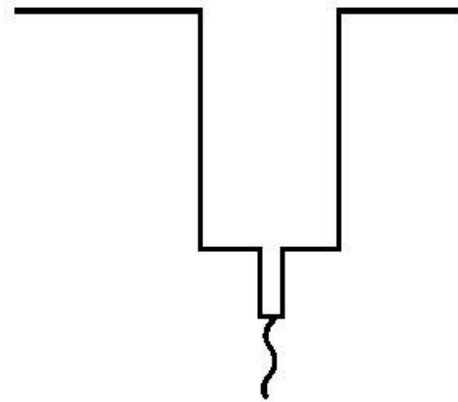

Rout out old sealant, debris and incompressibles. Clean joint sides to expose fresh, clean concrete and stone. Retain existing reservoir shape.

Fill to 1/8" below surface.
Do not overfill.

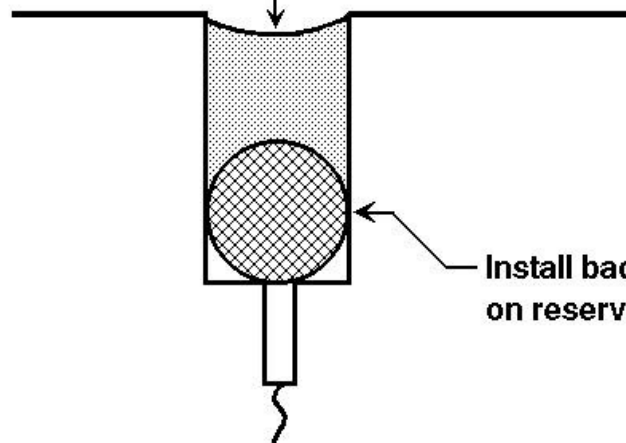

Install backer rope
on reservoir shelf.

Figure 6. PCC joint/crack repair.

